



Instruction ~~/Service~~ Manual

ALC Centrifuge
Model PK130R



ALC
170 Marcel Drive
Winchester, VA 22602
USA
Phone: 540-869-8623
Toll Free: 800-556-2323
FAX: 540-869-0693

Manual P/N 36100138
Rev B Dated 21SEP00

NOTICE

THE MATERIAL IN THIS MANUAL IS FOR INFORMATION PURPOSES ONLY. THE CONTENTS AND THE PRODUCT IT DESCRIBES ARE SUBJECT TO CHANGE WITHOUT NOTICE. ALC MAKES NO REPRESENTATIONS OR WARRANTIES WITH RESPECT TO THIS MANUAL. IN NO EVENT SHALL PRECISION BE LIABLE FOR ANY DAMAGES, DIRECT OR INCIDENTAL, ARISING OUT OF OR RELATED TO THE USE OF THIS MANUAL.

For repair information or replacement parts assistance from the manufacturer, call Customer Service using our toll free telephone number.

800-556-2323
(FAX) 540-869-0693

REVISION STATUS

| INDEX | DATE | AMENDED PAGES | NOTES |
|--------|---------|---------------------|---|
| A B | 20SEP00 | Service section p23 | Initial release Updated calibration info |

Contents

| | | |
|-----------|--|-----------|
| 1. | MANUFACTURER | 1 |
| 1.1 | Safety Devices and Notices | 1 |
| 2. | INSTALLATION 1 | |
| 2.1 | Transport, Packaging, Lifting | 1 |
| 2.2 | Installation | 1 |
| 2.3 | Power Source Wiring | 2 |
| 2.4 | Environmental Conditions | 2 |
| 2.5 | Lid Unlock | 2 |
| 2.6 | Emergency Lid Unlock | 2 |
| 2.7 | Inspection | 3 |
| 2.8 | Fitting the Rotor to the Drive Shaft | 3 |
| 2.9 | Removal of the Rotor | 3 |
| 3. | SPECIFICATIONS | 4 |
| 3.1 | Dimensions and Weight | 4 |
| 3.2 | Centrifugation Characteristics | 4 |
| 3.3 | Electrical Characteristics | 4 |
| 3.4. | Specifications | 4 |
| 4. | DESCRIPTION OF PERFORMANCE | 5 |
| 4.1 | Functional Principles | 5 |
| 4.1.1 | Drive System | 5 |
| 4.1.2 | Lid Interlock Safety System | 5 |
| 4.1.3 | Imbalance Sensor | 5 |
| 4.1.4 | Refrigeration System | 5 |
| 4.2 | Rotors - Performance | 6 |
| 4.2.1 | Rotors - Table | 6 |
| 4.2.2 | Performance | 6 |
| 4.3 | RCF Calculation | 7 |
| 4.4 | Processing and Control Interface | 8 |
| 5. | OPERATION PROCEDURE | 10 |
| 5.0 | Instructions for the Operator | 10 |
| 5.1 | Power Switch - Cover Unlock | 10 |
| 5.2 | Loading Balance | 10 |
| 5.3 | Centrifuge Operation | 11 |
| 5.3.1 | MANUAL Operative Mode | 11 |
| 5.3.2 | PROGRAM Operative Mode | 11 |
| 5.4 | Setting Centrifugation Parameters | 11 |
| 5.4.1 | Default condition | 11 |
| 5.4.2 | Acceleration | 12 |
| 5.4.3. | Braking | 12 |
| 5.4.4. | Setting Temperature, Speed and Time Values | 13 |
| 5.5 | How to Store a Program in Memory | 13 |
| 5.6 | How to Protect a Program | 13 |
| 5.7 | Starting the Centrifuge | 13 |
| 5.8 | Stopping the Centrifuge | 14 |
| 5.9 | Messages - Alarms | 14 |

| | | |
|------------|--|-----------|
| 6. | HAZARDS, PRECAUTIONS AND USE LIMITATIONS | 15 |
| 6.1 | Dangerous operations - work conditions to avoid | 15 |
| 6.2 | EN 61010-2-020 STANDARD | 15 |
| 6.3 | Rotor and Accessory Precautions | 16 |
| 6.3.1 | Corrosion Information | 16 |
| 6.3.2 | Contamination Hazards | 17 |
| 7. | ROUTINE MAINTENANCE | 18 |
| 7.1 | Rotating Equipment and Centrifugation Chamber Cleaning | 18 |
| 7.2 | Exterior Cleaning | 19 |
| 7.3 | Circuit Breaker | 19 |
| 8. | OPERATOR'S NOTES | 20 |
| 9. | CERTIFICATE of DECONTAMINATION and CLEANING | 21 |
| 10. | WARRANTY | 22 |

SERVICE SECTION

1. MANUFACTURER

For more information about the ALC PK120R centrifuge, please contact:

ALC
170 Marcel Drive
Winchester, VA 22602
Telephone (540) 869-8623
Toll Free (800) 556-2323
Fax (540) 869-0693

1.1 Safety Devices and Notices

To ensure operator safety the centrifuge has the following electrical and mechanical characteristics:

- The centrifuge will not start unless the lid is locked.
- The lid cannot be opened during centrifugation.
- The centrifuge has electronic self-diagnosis capability; any possible electrical system malfunctions are displayed digitally. At the same time, the centrifuge is disabled to prevent unsafe operation of the machine.
- The centrifuge is equipped with an automatic load imbalance safety device.
- The case of the centrifuge is armored, and the reinforced bowl is made of AISI 304 stainless steel.
- The lid is supported by a strong, dependable gas spring that holds the lid open until the operator actively closes it.
- The electrical main has a bipolar switch.
- Ground connection resistance, applied voltage and leakage current are tested and certified.
- The centrifuge is equipped with identification plates and operating instructions.

2. INSTALLATION

2.1 Transport, Packaging, Lifting



The centrifuge is shipped in special packaging to protect it from possible harm.

Due to the weight of the machine, proper handling equipment (e.g.: pallet jack or fork lift) must be used. The handling equipment should comply with current regulations, and should only be used by properly trained individuals.

1. The centrifuge should be stored and transported under the following conditions:
 - a) Ambient temperature -20°C to +50°C.
 - b) Relative humidity up to 90% and not exceeding the dew point.

2. After the centrifuge is unpacked, the contents of the package should be carefully compared to the items on the packing list.

3. Retain the packaging until the centrifuge has been tested.

2.2 Installation

The machine should be installed in a room free of dust and moisture. Place the centrifuge on a bench top rigid and strong enough to comfortably support its weight.

IMPORTANT:

AT LEAST 2 PEOPLE ARE REQUIRED TO LIFT THE CENTRIFUGE FROM THE PALLET AND PLACE IT ON THE BENCH.

WARNING:

LEAVE 12 INCHES OF FREE SPACE ON EACH SIDE OF AND BEHIND THE MACHINE TO FACILITATE PROPER VENTILATION.

2.3 Power Source Wiring



Check main lines and frequency: They must correspond to the values shown on the instrument identification label.

PK130R 230V:
230 V + 5% - 10% 50 Hz (1 phase + ground)

PK130R 120V:
120 V + 5% - 10% 60 Hz (1 phase + ground)



WARNING:

ENSURE THAT THE POWER SOURCE IS PROPERLY GROUNDED.

The centrifuge is equipped with R.F.I.. filters. The manufacturer declines all responsibility for any damages due to improper grounding of the machine.

2.4 Environmental conditions

- Indoor use.
- Temperature: 5°C to + 40°C.
- Maximum relative humidity: 80% for temperatures up to 31°C decreasing linearly to 50% relative humidity at 40°C.

2.5 Lid Unlock



1. Turn the centrifuge on (switch is on the left side of the unit).

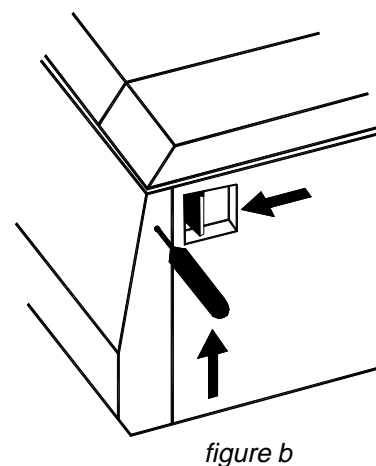
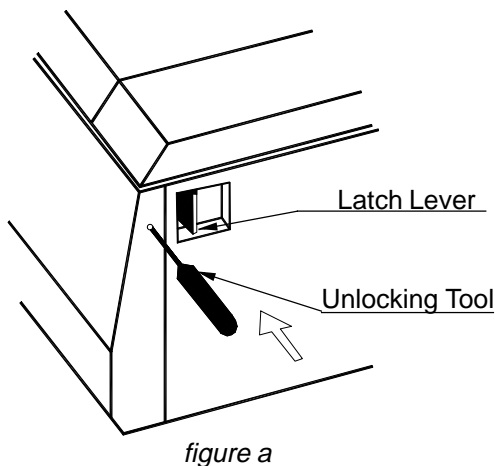

2. Check the lid indicator on the display panel. The light should be on indicating that the rotor is stationary and that the lid can be opened.
3. Pull the lever on the top right side of the machine to open the lid.



WARNING:

BEFORE PROCEEDING TO THE INSTALLATION OPERATION, IT IS IMPORTANT TO TURN THE CENTRIFUGE OFF.

4. After opening the lid, remove any possible packaging around the spindle. Unscrew the rotor nut from the top of the spindle. Carefully clean the inside of the centrifugation chamber removing any packaging residue. Because of the turbulence caused by centrifugation, solid particles accidentally left in the chamber could create excessive wear of the bowl and rotor.

2.6 Emergency Lid Unlock

In the event of power failure, the lid can be opened using the special tools supplied with the centrifuge. **The centrifuge must be unplugged before starting this procedure.**

1. Remove the nylon screw in the hole on the right side of the centrifuge as identified below.
2. Insert the unlocking tool, keeping the blade horizontal (*figure a*).
3. Lift the unlocking tool while simultaneously pulling the lever (*figure b*).

4. After the lid is open, replace the nylon screw.



WARNING:

SHOULD THE POWER FAIL DURING CENTRIFUGATION, WAIT AT LEAST 40 MINUTES FOR THE ROTOR TO STOP TURNING. OPEN THE LID CAUTIOUSLY AND OBSERVE THE ROTOR; IF IT IS STILL ROTATING, CLOSE THE LID AND WAIT 10 MINUTES MORE BEFORE REPEATING THE OPERATION.

2.7 Inspection

Before installation, the rotating equipment should be thoroughly inspected for corrosion and dirt (see 6.3). The rotor and spindle should be clean and undamaged. These accessories should be wiped clean before each use. Any failure to follow the above advice may have serious consequences for the safety of the appliance. Corrosion can lead to stress fatigue, which will eventually weaken the rotor and may lead to disruption and severe damage to the centrifuge. If visible signs of corrosion or anomalies in the rotor or buckets are present, do not use the affected accessories. Contact an authorized service provider for assistance.

2.8 Fitting the Rotor to the Drive Shaft

- Remove the rotor fixing shaft nut.
- Check the cleanliness of the shaft and the rotor.
- Place the rotor on the shaft.
- Secure the rotor on the shaft by turning the fixing nut clockwise.
- Tug on the rotor to make sure that it is secure.



WARNING:

BE SURE THAT THE ROTOR IS LOCKED BEFORE STARTING THE CENTRIFUGE.

2.9 Removal of the Rotor

To remove the rotor from the motor shaft : Using the wrench supplied, unlock the shaft nut. Remove the nut and lift the rotor with both hands.

3. SPECIFICATIONS

3.1 Dimensions and weight

Height x Width x Depth: 15 x 22.6 x 23.4 in (38 x 57,5 x 59,5 cm)
Net Weight: 159 lbs. (72 kg)

3.2 Centrifugation characteristics

Max. allowable capacity: with swing-out rotor 4 x 280 ml
with fixed-angle rotor 6 x 94 ml

Max. Allowable density: 1200 Kg/ m³
Max. allowable weight: 0.912 Kg

Max. speed: with swing-out rotor 4000 rpm
with fixed-angle rotor 6500 rpm

Max. RCF at tip: with swing-out rotor 2933 x g
with fixed-angle rotor 5289 x g

Set temperature: -10°C +40°C

Max. noise: < 59 dBA

3.3 Electrical characteristics

Nominal operating voltage: 230V + 5% - 10% 50 Hz
120V + 5% - 10% 60 Hz

Current..... 4.7A (@ 230V)
9.4A (@ 120V)

Max power (steady state): 520 W

3.4. Specifications

- Microprocessor controlled
- 5 program memory, direct recall
- Working temperature -10°C + 40°C. (accuracy: +/- 1,5° C.)
- Set/reading speed 300 - 6500 rpm (in steps of 10 rpm or 100 rpm); accuracy: +/- 20 rpm
- 5 acceleration profiles
- 5 deceleration profiles
- Set timer 1 min. up to 99 min. + ∞
- Electronic imbalance detector
- Direct drive
- Brushless induction motor

4. DESCRIPTION OF PERFORMANCE

4.1 Functional principles

The ALC PK130R centrifuge is designed for laboratory use. It will separate the components of fluids into layers of varying density by subjecting them to high forces. Swing out rotors can carry a greater load than fixed angle rotors. The larger the diameter of a rotor, with accessories, the greater its load capacity and the lower its maximum speed. Relative Centrifugal Force (RCF) generated by a rotor is directly proportional to its sedimentation useful radius and to the value of its speed squared.

4.1.1 Drive system

A three phase asynchronous motor drives the rotating equipment. The rotor is contained in a sealed, armor plated centrifugation chamber.

4.1.2 Lid interlock safety system

The centrifuge is equipped with an interlock system that prevents opening of the centrifuge lid when the rotor is spinning. The centrifuge will not operate until the lid is closed and latched in place. The lid remains latched until the rotor stops spinning. **NOTE:** If a power failure occurs, access to the samples in the centrifuge is possible. For this it is necessary to use a special tool. Follow the emergency lid unlock procedure found in Section 2.6.

4.1.3 Imbalance Sensor

The centrifuge is equipped with a load imbalance detector. In case of excessive imbalance the machine stops automatically. The display reads "IMbAL" – this message will disappear once the lid has been opened to balance the load (see Section 5.10). Imbalance tolerance depends upon the rotor in use. Carefully balance the sample load to avoid actuating the imbalance detection system.

4.1.4 Refrigeration System



The ALC PK130R is equipped with a powerful refrigeration system that allows samples to be processed at low temperature.

The actual temperature of the refrigeration chamber is continuously displayed on the front panel of the centrifuge. Under certain conditions (high speed, long duration runs) the sample temperature can be higher than the bowl temperature on the display. In this case, compensation can be made by the user after empirical determination of the temperature differential. The lid should remain closed when the refrigeration system is in use to avoid condensation. With the centrifuge stopped, the lid closed and bowl temperature (T) < 4°C, the refrigeration system will be switched off. With the bowl temperature (T) > 4°C and higher than the SET value the refrigeration system will be switched on. The refrigerant, **R134a**, is free of CFC (Chloro-Fluoro-Carbons) in accordance with the Montreal Protocol directions for preservation of the ozone layer in the atmosphere.

Condensation draining

The 130R has a rubber hose that allows condensation to be drained from the bowl. The drain hose exits the back side of the machine. Near the drain hose you can find the following label:

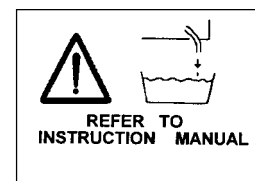

- Switch off the centrifuge and disconnect the power.
- Put a small basin under the pipe.
- Unplug the hose.
- Drain the centrifuge bowl.
- Insert the plug back into the hose.

ATTENTION: Do not remove the plug from the drain hose during centrifugation.

4.2 Rotors - Performance

4.2.1 Rotors - Table

| Type of Equipment | Load Composition | | Eq. Composition | | | Accessories | Useful max radius |
|-------------------|-------------------|----------|-------------------------|------------------|-----------------------|---------------------|-------------------|
| | Capacity | α | Rotating Head catalog # | Bucket catalog # | Sealing cap catalog # | Kit catalog # | |
| O-F25 | 4 X 280 ml | 0° - 90° | 11200091 | --- | 11172534 | CYTOKIT 11200093 | 0.164 |
| O-F17 | 2 X 3 microplates | 0° - 90° | 11200094 | --- | SMP KIT 11172616 | ---- | 0.115 |
| F-F6 | 30 X 15 ml | 40° | 11200095 | --- | ---- | ---- | 0.135 |
| A-F18 | 6 X 94 ml | 25° | 11200096 | ---- | ---- | ---- | 0.099 |
| A-F10 | 6 x 50 ml conical | 40° | 11200079 | ---- | ---- | ---- | 0.112 |
| A-F12 | 20 x 2.0/1.5 ml | 45° | 11200097 | ---- | ---- | ---- | 0.078 |

4.2.2 Performance

| Type of equipment | Max. speed (rpm) | Max RCF (xg) | Temperature at max speed |
|-------------------|------------------|--------------|--------------------------|
| O-F25 | 4000 | 2933 | 3°C |
| O-F17 | 3000 | 1157 | 0°C |
| F-F6 | 4000 | 2414 | 0°C |
| A-F18 | 6500 | 4675 | -6°C |
| A-F10 | 6500 | 5289 | -3°C |
| A-F12 | 6500 | 3684 | -8°C |

4.3 RCF Calculation

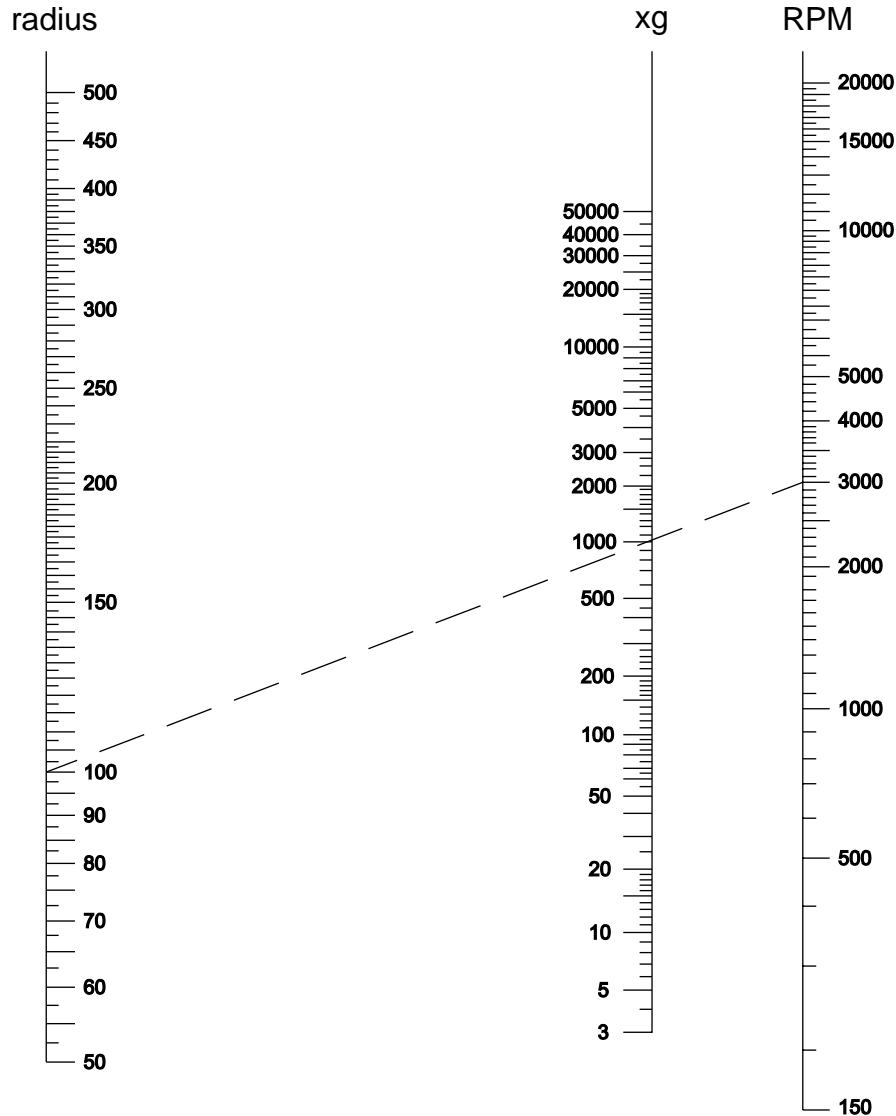

Total separating force applied to a sample in a centrifuge depends on the duration of the centrifuge run and on the RCF (relative centrifuge force) applied to the sample. RCF is generally calculated in units x gravity (x g). The diagram above allows you to graphically calculate RCF by drawing a line from the centrifugal radius (on left) to the speed (on right). The value of the RCF (xg) applied to the sample is approximated by the value at the point where the line crosses the “xg” axis (center).

Centrifugal radius is defined as the distance from the axis of rotation to the point on the sample at which you wish to measure the RCF. This point is generally the tip of the sample

farthest from the axis of rotation. By popular convention, this distance is measured in units of millimeters.

EXAMPLE

To find the RCF value (xg) applied to a sample in a rotor/bucket/accessory system with a centrifugal radius of 100 mm (0.1m) and rotating at 3000 RPM, place a ruler on the scale joining the point marked 100 on the left with the point marked 3000 on the right. At the point where the line crosses the center scale (xg), the corresponding value is approximately 1,000. In this example, the outer tip of the sample is subjected to RCF = 1,000 x g

The following functions represent the mathematical relationship between RCF (xg), centrifugal radius (r) and speed (rpm). When the accuracy of the graphical method described above is not satisfactory, these functions can be used to obtain more accurate results.





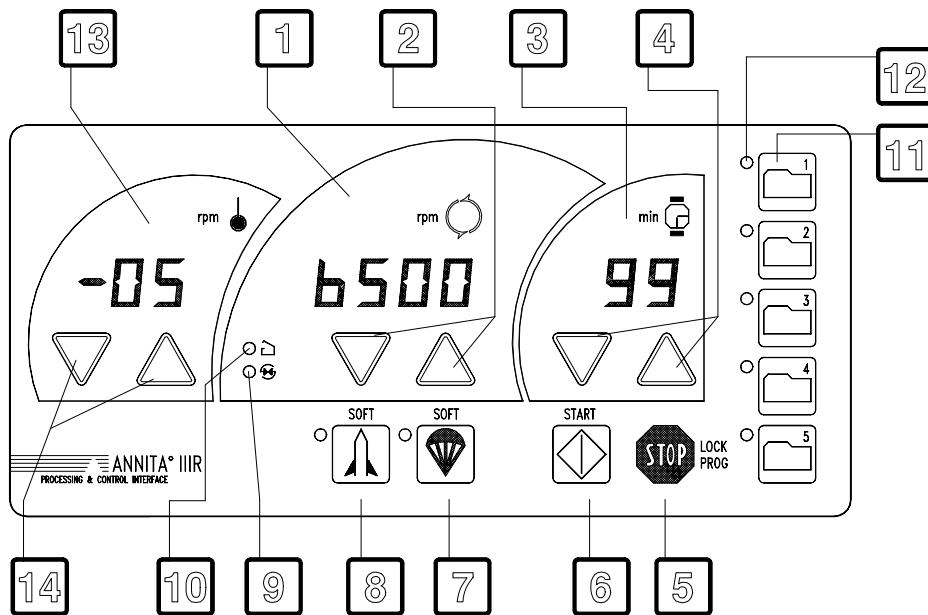

$$\text{RCF (units x g)} = 1.118 \cdot 10^{-6} \cdot n^2 \cdot r \text{ where } n = \text{RPM}$$

$$n = \sqrt{\frac{\text{rcf}}{1,118 \cdot 10^{-6} \cdot r}}$$

r = radius in millimeters

4.4 Processing & control interface



1. **Speed display (units of rpm)** When the machine is stopped, this field displays the set speed. When the machine is running and the numbers are constant, this field displays actual speed. When the machine is running and the numbers are flashing, this field displays set speed.
2. **SET rpm keys**   : These keys are used for increasing or decreasing speed settings.
3. **Time display (units of minutes)** When the machine is stopped, this field displays the set centrifugation time. When the machine is running, the remaining centrifugation time is displayed; when the time is set at "HOLD" (continuous operation), the display shows elapsed time.
4. **SET minutes keys**   : These keys are used for increasing or decreasing time settings.
5. **STOP key** Pressing this key stops the centrifuge manually. When pressed simultaneously with key N°. 12, it toggles the password protection of the programs in memory.
6. **START key** Pressing this key starts the centrifugation cycle.
7. **SOFT deceleration key** This key is used to set low braking rate (illuminated LED indicates "on"). The braking rate can also be more precisely programmed to one of 5 deceleration profiles.
8. **SOFT acceleration key** This key is used to set low acceleration rate (illuminated LED indicates "on"). The acceleration rate can also be more precisely programmed to one of 5 acceleration profiles.
9. **GREEN LED:** This indicator flashes during the acceleration and the deceleration phases. It is constant when actual speed equals set speed.
10. **YELLOW LED:** When this indicator is illuminated the lid can be opened. It comes on when the rotor is stationary.
11. **Five PROGRAM KEYS:** for quick programming and recall of 5 profiles.
12. **Five LED indicators next to program keys:** When a program is selected, its corresponding LED is illuminated.
13. **TEMPERATURE DISPLAY:** This display shows the actual bowl temperature when the numbers are constant. When the display is flashing, the set temperature is displayed.
14. **SET Temperature Keys**   : Pressing the "up" or "down" key increases/ decreases the set temperature value.

5. OPERATION PROCEDURE

5.0 Instructions for the operator

1. As a precautionary measure, the operator should remain with the centrifuge until it reaches the set speed.
2. The operator should also return to the centrifuge immediately upon completion of the run.

5.1 Power Switch - Cover Unlock

1. When the centrifuge is turned on (switch is located on the left side of the centrifuge) both the centrifuge and the refrigeration circuit are connected to the main circuit.
2. When the rotor is stationary and the LED is on, it is possible to unlock the lid. The mechanical latch on the upper right panel of the centrifuge opens the lid when it is pulled toward the front.

5.2 Loading balance

5.2.1 All rotating equipment is dynamically balanced prior to shipment. For swinging bucket rotors, reference numbers and marks on the buckets correspond to matching marks on the rotor. Buckets should be positioned on the rotor so that the numbers on the buckets correspond to the same numbers on the rotor itself (eg. bucket #2 positioned in rotor position #2, see fig. 1).

5.2.2. For fixed angle rotors with carriers, all carriers must be inserted into the rotor before starting the run. This holds true even when partial loads are being processed (see fig. 2).

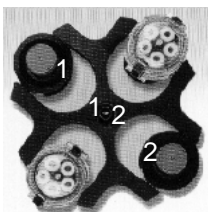

figure 1

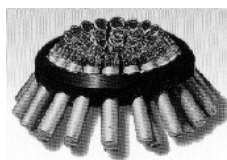

figure 2

5.2.3 Because buckets and carriers are pre-balanced, the buckets should never be weighed, but only their contents (adapters, tubes, etc.).

5.2.4 To correctly distribute the load, tubes and adapters should be placed so that the load is symmetrically distributed with respect to the axis of rotation. (see fig. 3)

5.2.5 For partial loads of swing-out rotating equipment tubes should also be symmetrically distributed with respect to the rotational axis of the swinging bucket. (see fig. 4).

5.2.6 When liquids with densities higher than 1.2 gm/ml must be processed, the max. rpm should be reduced according to the following formula:

$$\text{Allowed rpm} = \text{max. rpm} \cdot (1.2/\text{New density})$$

5.2.7 When closing the lid, lower it pressing on the front edges until the hook in the lid clicks into the lid lock mechanism. The centrifuge will only operate when the lid is completely closed and locked. **NOTE:** Tubes should be balanced within ± 2 grams to facilitate the best possible sample separation.

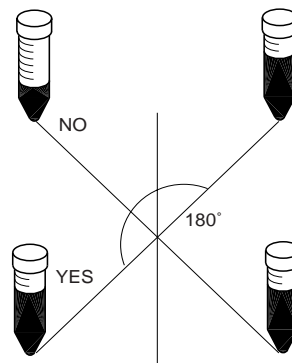

figure 3

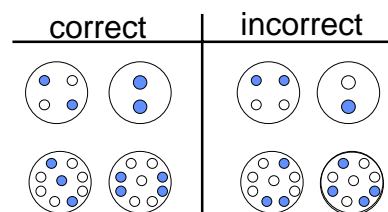

figure 4

5.3 Centrifuge Operation

INTRODUCTION: The control interface of the PK130R is designed to make centrifuge operation as simple as possible. All of the buttons are dedicated to specific functions. Because of this, centrifuge operators do not need extensive training to understand the system. This section is designed to educate and prepare the user to use the PK130R. The following centrifugation parameters can be set by the operator:

- a) *Speed in rpm* (300 rpm up to 6,000 rpm).
- b) *Centrifugation time* (1 min up to 99 min + ∞)
- c) *Temperature* (-10°C to +40°C)
- d) *Acceleration* (5 profiles)
- e) *Braking* (5 profiles)

The microprocessor allows the centrifuge to be operated in **MANUAL** or in **PROGRAM** operative mode.

5.3.1 MANUAL Operative Mode

Manual operative mode is active when none of the five programs is activated. When the centrifuge is in manual mode, none of the LED's next to the program keys are illuminated. In manual mode, all of the parameters can be changed regardless if the centrifuge is running or on stand-by. For example: The user approaches the centrifuge wishing to operate it in manual mode. The LED indicator next to Program #3 is illuminated. To put the centrifuge into Manual mode, the user presses the button corresponding to Program #3 once. The LED goes off, indicating that the centrifuge is now in Manual mode.

5.3.2 PROGRAM Operative Mode

Up to 5 programs can be stored in the memory of the PK130R. To set or change programs, follow this procedure:

- Make sure that the centrifuge is in **MANUAL** mode (all LED indicators next to program buttons are off).
- Set all parameters for your desired program. The display numbers will blink for about three seconds after you are done programming.
- Before the numbers stop blinking, press the program button for the program number under which you wish to store the protocol. This will save the newly-created program.
- To select a program, press the button corresponding to the program number that you wish to recall.

5.4 Setting Centrifugation Parameters

5.4.1 Default Condition

The centrifuge is always in the same operative mode as at the time of its last use. When the centrifuge is idle the display reads:

- °C- Real temperature in the centrifugation chamber
- rpm* - set speed
- min* - set time

5.4.2 Acceleration

The ALC PK130R control system allows the user to set acceleration rates in two different ways. The first method involves a simple choice between high or low acceleration rates.

High acceleration (LED off)
Low acceleration (LED on)

 The system also allows for a more rigorous choice with 5 possible profiles. This method is as follows:

1. Press the  (with LED on) for 3 sec.
 (The rpm-display shows “**ACL**” flashing and a number between 1 and 5)
2. With acceleration key still pressed, use the **SET rpm keys** ∇ \triangle to select an acceleration curve between 1 and 5.

5.4.3. Braking

The PK130R control system allows the user to set braking rates in two different ways. The first method involves a simple choice between high or low braking rates.

High braking rate (LED off)
Low braking rate (LED on)

 The system also allows for a more rigorous choice with 5 possible profiles. This method is as follows:

1. Press  (with led on) for 3 sec.
 (The rpm-display shows “**dCL**” flashing and a number between 0 and 4).
2. With deceleration key still pressed, use the **SET rpm keys** ∇ \triangle to select a braking curve between 0 and 4 (0 = inertial braking).

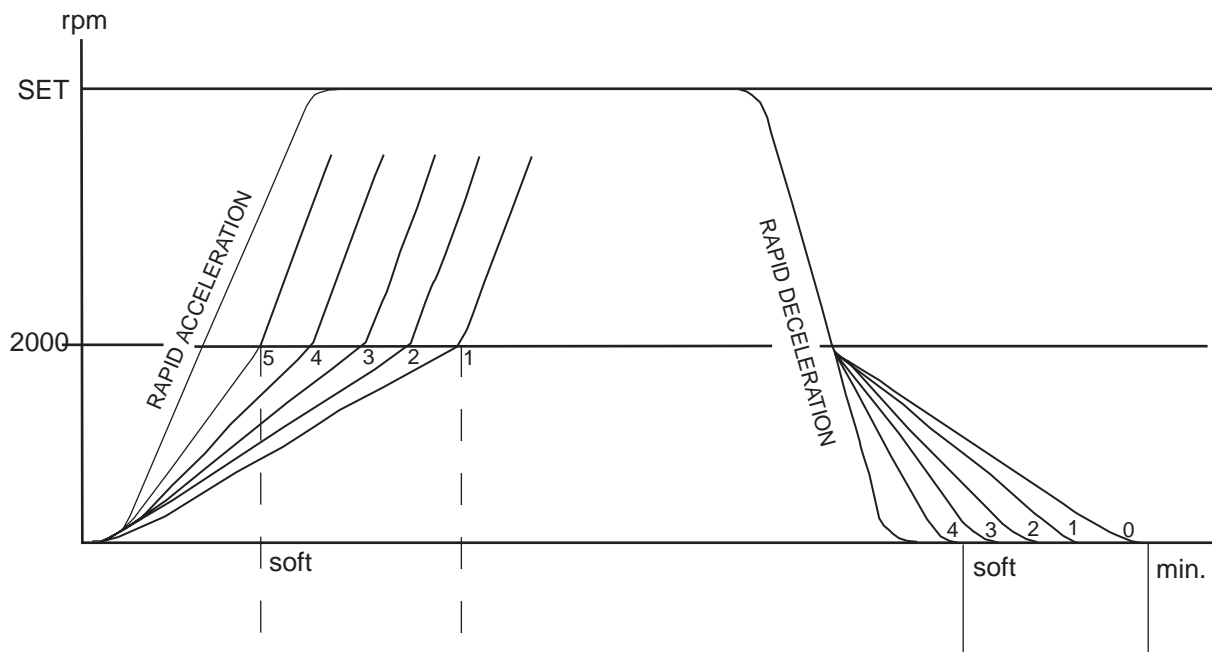

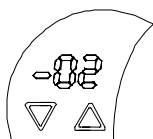

figure 5.4 Acceleration & Braking

5.4.4. Setting speed and time values

- When you touch one of the **SET** keys   , the corresponding display will start to flash.
- When the display flashes, it is possible to change the selected parameter using the **SET keys**.



SET **temp** -10 °C to +40 °C (actual temp depends on load; see 4.2).

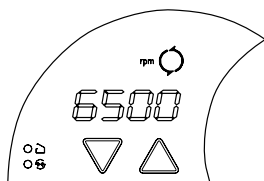

SET **speed** 300 to 6000 rpm (see 4.2 for rotor speed ratings).

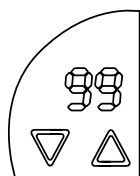

SET **time** 1 to 99 min + hold

3 seconds after changes are complete, the display stops flashing. This confirms the new SET values.

5.5 Storing a program in memory

BASIC CONDITION: Centrifuge stationary and “MANUAL” Operative Mode.

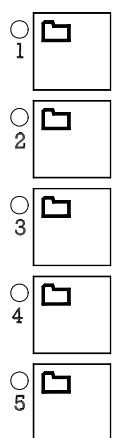

1. To store the SET parameters **press one of the program keys between 1 and 5 while the display is still flashing (within three seconds of the last button operation)**. The **LED** next to the **program key** will light up, confirming that the program has been memorized. **NOTE:** *It is not possible to set a program with time set to “HOLD”: if you try to put a “HOLD” program into memory, the timer display will continue flashing; you must enter a determinate time value.*

2. To restore “**MANUAL MODE**”, press the selected **program key**; the LED corresponding to the program key goes off and it is possible to create a new program.

5.6 Protecting a program



1. To protect a program, press the **LOCK PROG key (STOP)** simultaneously with the program key when saving the program.

2. To cancel the program protection, press the **LOCK PROG key (STOP)** simultaneously with the program key.

5.7 Starting the centrifuge

BASIC CONDITION: Lid closed

1. Press “**START**” key.



In **MANUAL OPERATIVE MODE** and in **PROGRAM MODE**, the centrifuge will accelerate to the set speed. When the run time is elapsed, the centrifuge will brake to a stop.

- During the run time **temperature** and **speed** display shows actual values. The **time** display shows remaining run time. If the time setting is “HOLD”, the **time** display shows elapsed run time.
- The green LED on the left side of the control panel flashes while the rotor is accelerating and remains constantly illuminated while the rotor is at set speed.

NOTE: *if set **speed** is higher than the maximum speed of the rotor, the green LED will continue flashing (see 5.10 SET). In this case, the program should be corrected as soon as possible.*

2. **During the run in “MANUAL” MODE** To read and change set values, press the SET cursors:

- The display starts to flash and shows the set values for 3 seconds.
- While the display is flashing it is possible to change the set values.
- During a run in MANUAL mode it is possible to change the deceleration

3. **During the run in “PROGRAM” MODE,** it is possible to display set values by pressing the corresponding SET cursors. It is not possible to change the programmed values.

5.8 Stopping the centrifuge



Once the pre-set time has elapsed, the centrifuge automatically stops the rotor at a rate determined by the deceleration setting.

Pressing  at any time will cause the centrifuge to stop the rotor. **NOTE:** *Automatic braking will occur under conditions of load imbalance, power failure, error or breakdown. In all cases the relevant code will appear on the message display.*

5.9 Messages - Alarms

The microprocessor displays error messages to indicate errors, malfunctions or breakdowns. The messages are expressed with the following codes.

End Appears at the end of every centrifugation cycle after the rotor comes to a stop. The message disappears when the lid is opened or when any key is pressed.

Lid Appears when the  (start button) is pressed and the lid is not locked. The “LID” message is accompanied by an audible signal. This message will disappear when the lid is locked.

IMbAL Appears when the load is unbalanced. The message is accompanied by an audible signal. The centrifuge stops to allow the user to rebalance the load (5.2). The message disappears when the lid is opened.

MAInS Appears when a power failure occurs. The centrifuge decelerates and the system shuts down. When power is restored, the message reappears. It remains on the display until the next operation is started.

SET Appears when set speed is higher than the maximum rated speed of the rotor. The message disappears when the centrifuge is stopped or when the parameter is corrected in Manual Operative Mode.

E01-E09 Messages ‘E0..’ (e.g. E01) together with an acoustic alarm indicate failure conditions. The ‘E04’ message will appear on the display after a power failure, in this case wait for the rotor head to stop before opening the lid. In the other cases contact ALC Customer Service.

SET Appears when set speed is higher than the maximum rated speed of the rotor. The message disappears when the centrifuge is stopped or when the parameter is corrected in Manual Operative Mode.

E01-E09 Messages 'E0..' (e.g. E01) together with an acoustic alarm indicate failure conditions. The 'E04' message will appear on the display after a power failure, in this case wait for the rotor head to stop before opening the lid. In the other cases contact ALC Customer Service.

6. HAZARDS, PRECAUTIONS AND USE LIMITATIONS

6.1 Dangerous operations - work conditions to avoid

- Using the centrifuge if it has not been properly installed.
- Fitting the rotor on the drive shaft incorrectly or placing the buckets on the rotor incorrectly.
- Leaning on the machine.
- Placing dangerous objects in the area of the centrifuge.
- Moving or shifting the machine during centrifugation.
- Using the centrifuge with rotors and/or buckets showing corrosion, wear marks and/or cracking.
- Using the centrifuge with rotors and/or accessories not approved by the manufacturer.
- Using the centrifuge in explosive environments or with explosive samples or chemical materials subject to violent reaction.

- Running an unbalanced load which causes excessive vibration of the centrifuge.
- Running a rotor without its full complement of buckets or carriers, even for partial loads.
- Leaving the appliance exposed to the elements (rain, sun, etc.).
- Exceeding the maximum speed indicated in the "max. rpm" column of the performance table (see 4.2.2).
- Using old accessories on a new machine.
- Using tubes and/or bottles not suited for centrifugation.
- Spinning samples of densities higher than allowed for the given speed.
- Alteration of and/or tampering with the electronic and mechanical parts of the centrifuge.

6.2 EN 61010-2-020 STANDARD

The En 61010-2-020 standard relative to laboratory centrifuges recommends that the user:

- Mark out a clearance envelope 300 mm around the centrifuge or establish special procedures for the non entry of all persons or all dangerous materials into this space during the operation of the centrifuge.
- Provide an emergency stop switch enabling the main power source to be cut in the case of malfunction. The switch should be placed at a safe distance from the centrifuge, preferably in a different room from that in which the centrifuge is situated.

6.3 Rotor and accessory precautions

6.3.1 Corrosion information

ALC rotors are made of aluminium alloy and are designed to operate at their rated RCF for many years. With careful use they will resist corrosion, lowering the possibility of excessive imbalance, disruption and subsequent damage to the instrument. The primary conditions for the initiation of corrosion exist in every laboratory during daily use of the centrifuge. For this reason it is essential that due care and attention be paid to inspection and cleaning.

CHEMICAL CORROSION

This corrosion is characterized by chemical reactions due to the existence of any electrolytic liquid on the surface of the equipment. If these substances are allowed to remain on the surface corrosion will almost certainly occur. The first sign of this type of corrosion is a discoloration or pitting of the anodized surface.

Acidic and alkaline solutions sustaining their pH level will also create corrosion of aluminium equipment. Chlorides, which are present in salts (human skin secretions are a common source!), are among the most aggressive and harmful substances commonly found in the laboratory.

Chemical products that cause corrosion do not necessarily originate from broken tubes. For example, they could come from:

- Chemical vapors present in the laboratory which condense on the centrifuge and its accessories.
- Corrosive liquids originating from overfilled uncapped tubes (the liquid overflows during centrifugation)
- Inserts, adapters, racks and bottles with exteriors soiled by a chemical product or poorly rinsed after decontamination (with bleach, for example).

NOTE: If the products are very corrosive, simple rinsing is insufficient. Residual traces

dissolve little by little with the humidity present in the bottom of the rotor pocket.

BEWARE of the presence of solid particles beneath tubes, inserts, racks or adapters. These particles are crushed by the centrifugal force and penetrate the protective, anodized layer of buckets and rotors, thus creating pathways for corrosion.

STRESS CORROSION

This term relates to the phenomenon of accelerated corrosion due to the effect of centrifugal force when a corrosive chemical is in contact with the alloy. From the time when the aluminium alloy has been attacked by chemicals, stress corrosion begins to appear. As it occurs on a microscopic scale it is even more dangerous than macroscopic corrosion since it is invisible to the naked eye.

During centrifugation chemicals responsible for corrosion are also subjected to very high forces, which push them against the alloy. This close contact facilitates the chemical reaction which occurs much faster than it does in a static situation. Moreover, centrifugal force is directional. Because of this, corrosion under stress creates, with a very small amount of corrosive product, straight microscopic fissures. Each centrifugation run allows the chemical to migrate further and further.

Fissures or cracks, although microscopic, are a flaw in the metal, breaking the cohesion of the material. As one weak link in a chain allows the chain to break, so the microfissures break the chain of resistance of the accessory to centrifugal force. Because accessories are designed with high safety factors, rupture does not occur as soon as the first microfissures are produced.

Depending on the location of the fissure, disruption may occur before it reaches the external surface of the accessory. The fissure creates a weakness, which makes the accessory less and less resistant to mechanical fatigue. The corrosion caused by

a small amount of corrosive product does not disrupt the accessory but makes it mechanically weaker and weaker until disruption occurs due to both centrifugal force and fatigue.

 **WARNING:**

BECAUSE STRESS CORROSION IS LARGELY INVISIBLE, IT IS ESSENTIAL THAT ROTATING EQUIPMENT BE SCRUTINISED REGULARLY PAYING PARTICULAR ATTENTION TO SUSCEPTIBLE PARTS SUCH AS THE BOTTOM OF POCKETS, THE OUTER EDGES AND THE BASE OF THE ROTATING EQUIPMENT.

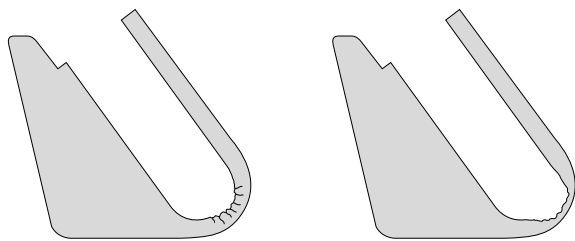

STRESS CORROSION

CHEMICAL CORROSION

6.3.2 Contamination hazards

ALC centrifuges are likely to be used in laboratories where hazardous substances are frequently present.

 **WARNING:**

THE USER HAS THE RESPONSIBILITY FOR CARRYING OUT APPROPRIATE DECONTAMINATION PROCEDURES. USERS SHOULD BE AWARE OF THE INTERNATIONALLY RECOGNIZED "LABORATORY BIOSAFETY MANUAL", WHICH GIVES INFORMATION ON DECONTAMINATES, THEIR USE, DILUTIONS, PROPERTIES AND POTENTIAL APPLICATIONS. IF HAZARDOUS MATERIAL IS SPILLED ON OR INSIDE THE APPLIANCE, CLEAN THE APPLIANCE AND ITS DRAIN HOSE USING APPROPRIATE METHODS.

If decontamination procedures require the use of warming (eg. autoclave) the rotating equipment should always be completely disassembled before being subjected to heat. They should also be completely disassembled prior to external chemical cleaning. Seals, tubes and plastic components should be decontaminated with the method most suitable for them, which might not be the same as for the rotating equipment.

Note that the black color on the surface of the rotating equipment will be gradually washed out if the rotor is regularly autoclaved or bleached. This does not necessarily denote degradation of the anodized surface.

 **WARNING:**

ANY PART WHICH HAS BEEN SUBJECTED TO TEMPERATURES ABOVE 130°C MUST BE DISCARDED.

 **WARNING:**

IF YOU HAVE A DOUBT ABOUT A PARTICULAR CLEANING METHOD, PLEASE CONTACT NAPCO TO VERIFY THAT THE PROPOSED METHOD DOES NOT DAMAGE THE APPLIANCE.

ALC makes no claims as to the effectiveness of proprietary brands of decontaminating solutions.

7. ROUTINE MAINTENANCE

CAUTION:

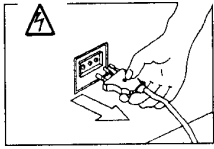

fig. 7.1

During maintenance operations, **ALWAYS** disconnect the centrifuge from the main power source (fig. 7.1).

7.1 Rotating Equipment and Centrifugation Chamber Cleaning

Regular cleaning of rotors and of the centrifugation chamber is vital to maintain good working conditions. The operator must wear proper protective equipment during the cleaning (mask, gloves, etc.). It is also important to verify the integrity of biosafety components when they are used. The user should always inspect the condition of seals and lids prior to using them. Do not clean them with materials that damage silicone and polycarbonate. Ideally, rotors should be washed after every run (at least weekly) in warm water containing a few drops of mild (not alkaline) detergent (domestic liquid soap is ideal). **ROTORS MUST BE WASHED EVERY TIME SPILLAGE OCCURS.** Do not forget to wash the core of the rotating head that comes into contact with the drive spindle. Each rotor pocket (and bucket for swing-out rotors) must be washed thoroughly using a small nylon brush. Once the rotor has been removed, it is easy to clean the centrifugation chamber and gaskets. Use warm water with non-alkaline detergent. Do not use corrosive solvents. Once the rotor is clean, rinse it with running water, preferably distilled. Dry the rotor with a soft absorbent non-woven cloth or tissue. The equipment can be dried with a cloth or with a hair dryer. **DO NOT USE METAL WIRE BRUSHES** and **MAKE CERTAIN THAT ROTOR SLOTS AND BUCKETS ARE WELL-DRIED** (fig. 7.2). **NEVER LEAVE** damp rotors on a metal surface (particularly stainless steel) because an electrochemical reaction could

take place with the aluminium or magnesium in the rotor. For swing-out rotors, be sure to clean the dirty grease from the studs and replace it with a small amount of fresh grease. This will ensure that the buckets swing freely. The majority of imbalance problems arise from the failure of the user to clean and grease the studs. **Never apply grease if studs and balancing slots have not been carefully cleaned** (fig. 7.3 a/b). Use only the same kind of greases furnished in the rotor packaging.

The refrigerated centrifuge PK130R is equipped with a chamber drain hose that allows the evacuation of excessive condensation: - Switch off the centrifuge and disconnect the electrical plug. - Put a small basin under the pipe. - Take the cap off of the pipe and allow the condensation to drain. - Insert the cap when finished. - Insert the electrical plug. **ATTENTION:** Never take the cap from the drain hose during centrifugation.

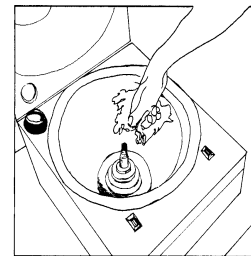

fig. 7.2

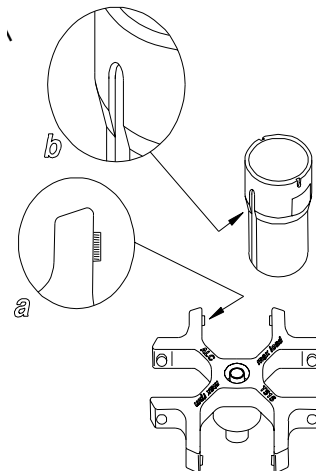

fig. 7.3

7.2 Exterior cleaning

For correct cleaning, a light domestic-use detergent is recommended. A mixture of 50% isopropyl alcohol and water is also suggested because it will not damage the labels.

7.3 Circuit breaker

It replaces the double protection fuse, and disconnects the centrifuge from the power source if something short circuits or if too much current is drawn. If the main circuit breaker cuts off the power to the instrument, do not attempt to switch on before a service engineer has checked the unit.

9. CERTIFICATE of DECONTAMINATION and CLEANING

(For your convenience, use a copy of this page)



Read the instructions below carefully before sending an instrument, or parts of it, to

ALC Technical Service.

| | |
|--|--------------------|
| MR / MRS (NAME) _____ | |
| ESTABLISHMENT _____ | |
| DEPARTMENT _____ | |
| ADDRESS _____ POST / ZIP CODE _____ | |
| CITY _____ STATE / COUNTRY _____ | |
| CERTIFIES the cleaning and decontamination of the following: | |
| CENTRIFUGE _____ SERIAL N° _____ | |
| ROTOR _____ SERIAL N° _____ | |
| ROTOR _____ SERIAL N° _____ | |
| ACCESSORY - Description _____ SERIAL N° _____ | |
| ACCESSORY - Description _____ SERIAL N° _____ | |
| NATURE of contamination | |
| _____ | |
| _____ | |
| Decontamination PROCEDURE USED | |
| _____ | |
| _____ | |
| Decontamination CERTIFIED by: | |
| Mr / Mrs. _____ | Institution: _____ |
| Date _____ | Signature: _____ |

When an instrument, or parts of it, comes back after demonstration and requires servicing by Technical Service personnel, the following procedure must be followed to ensure safety:

- Clean the instrument and decontaminate it.
- Complete this *Decontamination Certificate* with all the information required.
- Attach this *Certificate* to the instrument (or accessory) before sending it to ALC.

Technical Service personnel **will not accept** instruments without this *Decontamination Certificate*.

Warranty

ALC warrants its products against defects in material or in workmanship when used under appropriate conditions and in accordance with appropriate operating instructions for a period of no less than one (1) year from the date of delivery of the products.

The sole obligation of **ALC** shall be to repair or replace at our option, FOB factory or locally, without charge, any part(s) that prove defective within the warranty period, provided that the customer notifies **ALC** promptly and in writing of any such defect. Compensation for labor by other than **ALC** employees will not be our obligation. Part(s) replacement does not constitute an extension of the original warranty period.

ALC makes no warranty of merchantability, fitness for a particular purpose, or any other warranty, express or implied, as to the design, sale, installation, or use of its products, and shall not be liable for consequential damages resulting from the use of its products.

ALC will not assume responsibility for unauthorized repairs or failure as a result of unauthorized repairs, replacement, or modifications made negligently or otherwise improperly made or performed by persons other than **ALC** employees or authorized representatives.

While our personnel are available to advise customers concerning general application of all manufactured products, oral representations are not warranties with respect to particular application and should not be relied upon if inconsistent with product specification or the terms stated herein.

In any event, the terms and conditions continued in **ALC**, formal sales contracts shall be controlling; and any changes must be in writing and signed by an authorized executive of **ALC**.

All defective components will be replaced without charge for one (1) year from the date of delivery. There will be no charge for labor if the apparatus is returned to the factory prepaid.

Conditions and qualifications of the warranty statement shall prevail at all times.