

**ROTINA 380
ROTINA 380 R**



Ⓓ	Bedienungsanleitung	5
Ⓔ	Operating Instructions	31
Ⓕ	Mode d'emploi	55
Ⓘ	Istruzioni per l'uso	82

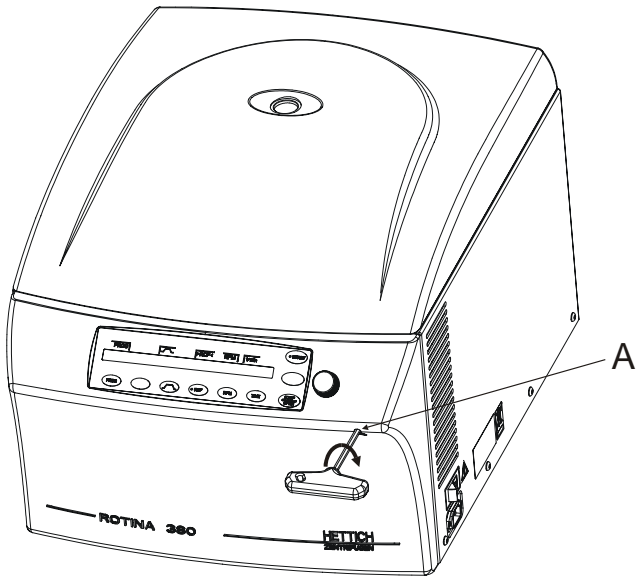

Fig. 1

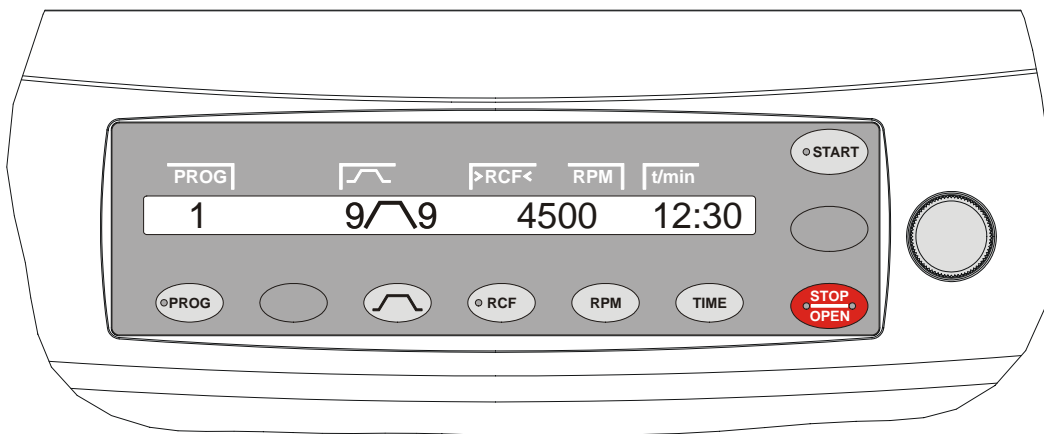

Fig. 2 ROTINA 380

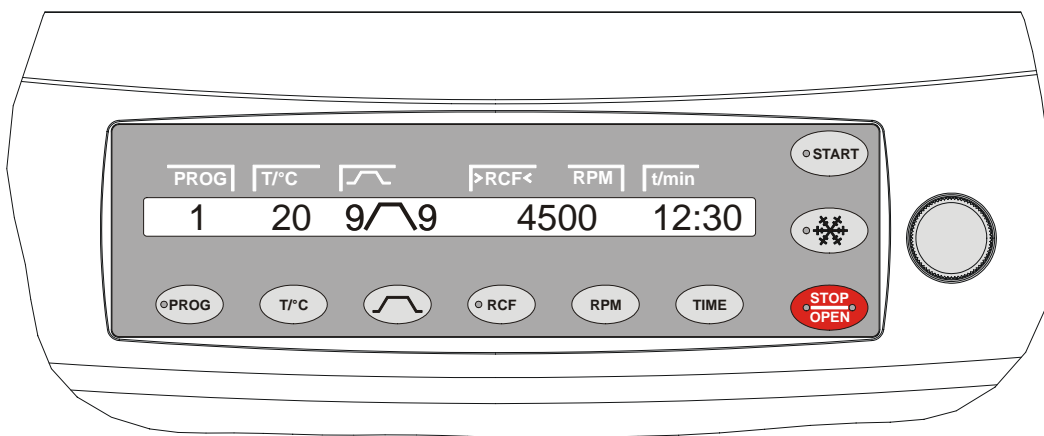

Fig. 3 ROTINA 380 R



**EG-Konformitätserklärung
EC Conformity Declaration
Déclaration de conformité CE
Dichiarazione di conformità alle norme CEE**

Andreas Hettich GmbH & Co. KG • Föhrenstraße 12 • D-78532 Tuttlingen • Germany

Das bezeichnete Gerät, inklusive Zubehör entspricht den aufgeführten EG-Richtlinien und Normen.
The denoted device, including accessories corresponds to the listed EC guidelines and standards.
L'appareil désigné, y compris les accessoires, correspond aux directives CE et aux normes énumérées.
L'apparecchio designato, compresi gli accessori, è conforme alle direttive CE e alle norme citate.

Geräteart, Type of device, Type d'appareil, Tipo di apparecchio:

Laborzentrifuge mit Zubehör, Laboratory centrifuge with accessories, Centrifugeuse de laboratoire avec des accessoires, Centrifuga da laboratorio con accessori

Typenbezeichnung, Type designation, Désignation de modèle, Contrassegno tipo:

ROTINA 380 / ROTINA 380 R

EG-Richtlinien/Normen, EC guidelines/standards, Directives CE/Normes, Direttive/Norme CEE:

2006/95/EG, EN 61010-1:2001, EN 61010-2-020:2006

2004/108/EG, EN 61326-1:2006

2006/42/EG, EN ISO 12100-1:2004, EN ISO 12100-2:2004

98/79/EG

H. Eberle
Geschäftsführer, Manager,
Directeur, Gerente

Tuttlingen, 28.09.2009



Andreas Hettich GmbH & Co. KG
Föhrenstraße 12, D-78532 Tuttlingen / Germany
Phone +49 (0)7461 / 705-0
Fax +49 (0)7461 / 705-125
info@hettichlab.com, service@hettichlab.com
www.hettichlab.com



© 2008 by Andreas Hettich GmbH & Co. KG

All rights reserved. No part of this publication may be reproduced without the prior written permission of the copyright owner.

Änderungen vorbehalten! , Modifications reserved! , Sous réserve de modifications ! , Con riserva di modifiche!

AB1701DEENFRIT / Rev. 01 / 06.10

Inhaltsverzeichnis

1	Bestimmungsgemäße Verwendung	7
2	Restrisiken	7
3	Technische Daten	7
4	Sicherheitshinweise	8
5	Bedeutung der Symbole	9
6	Lieferumfang	10
7	Auspacken der Zentrifuge	10
8	Inbetriebnahme	10
9	Schnittstelle (nur bei Zentrifuge mit Schnittstelle)	10
10	Deckel öffnen und schließen	11
10.1	Deckel öffnen	11
10.2	Deckel schließen	11
11	Ein- und Ausbau des Rotors	11
12	Beladen des Rotors	12
13	Winkelrotoren aerosoldicht verschließen	12
14	Bedien- und Anzeigeelemente	13
14.1	Drehknopf	13
14.2	Tasten und Einstellmöglichkeiten	13
15	Zentrifugations-Parameter eingeben	14
15.1	Laufzeit	14
15.2	Drehzahl (RPM)	15
15.3	Relative Zentrifugalbeschleunigung (RCF) und Zentrifugierradius (RAD)	15
15.3.1	Zentrifugierradius (RAD)	15
15.3.2	Relative Zentrifugalbeschleunigung (RCF)	15
15.4	An- und Auslauf-Parameter	15
15.4.1	Anlaufstufe	15
15.4.2	Bremsstufe	15
15.4.3	Bremsabschaltungs-Drehzahl	15
15.5	Temperatur (nur bei Zentrifuge mit Kühlung)	15
16	Programmierung	15
16.1	Voreingestellte Programme	16
16.2	Programme eingeben oder ändern	16
16.3	Programme abrufen	16
16.4	Schreibschutz für Programme	16
16.5	Programmverknüpfung	17
16.5.1	Programmverknüpfung aktivieren oder deaktivieren	17
16.5.2	Programme verknüpfen oder eine Programmverknüpfung ändern	17
16.5.3	Programmverknüpfung abrufen	17
16.6	Automatischer Zwischenspeicher	18
17	Zentrifugation	18
17.1	Zentrifugation mit Zeitvorwahl	18
17.2	Dauerlauf	18
17.3	Kurzzeitzentrifugation	19

18	Einstellungen während des Zentrifugationslaufes ändern	19
19	Not-Stop	19
20	Akustisches Signal	19
21	Angezeigte Zentrifugations-Daten nach dem Einschalten	20
22	Temperatur-Einheit einstellen (nur bei Zentrifuge mit Kühlung)	20
23	Programm-Verriegelung einstellen	20
24	PIN (Persönliche Identifikationsnummer)	21
24.1	PIN einstellen oder ändern	21
24.2	Vergessene PIN ändern	21
25	Adresse der Zentrifuge	21
26	Funktionen RCF-Integral und B-Ramp	21
27	Abfrage der Betriebsstunden und der Anzahl der Zentrifugationsläufe	22
28	Abfrage von System-Informationen	22
29	Sofortige Anzeige der Zentrifugations-Daten nach dem Einschalten	22
30	Kühlung (nur bei Zentrifuge mit Kühlung)	22
30.1	Standby-Kühlung	22
30.2	Vorkühlen des Rotors	23
31	Heizung (nur bei Zentrifuge mit Option Heizen/Kühlen)	23
32	Relative Zentrifugalbeschleunigung (RCF)	23
33	Zentrifugation von Stoffen oder Stoffgemischen mit einer höheren Dichte als 1,2 kg/dm ³	24
34	Rotor-Erkennung	24
35	Notentriegelung	24
36	Pflege und Wartung	25
36.1	Zentrifuge (Gehäuse, Deckel und Schleuderraum)	25
36.1.1	Oberflächenreinigung und -pflege	25
36.1.2	Oberflächendesinfektion	25
36.1.3	Entfernen radioaktiver Verunreinigungen	25
36.2	Rotoren und Zubehör	26
36.2.1	Reinigung und Pflege	26
36.2.2	Desinfektion	26
36.2.3	Entfernen radioaktiver Verunreinigungen	26
36.2.4	Tragzapfen	26
36.2.5	Rotoren und Zubehör mit begrenzter Verwendungsdauer	27
36.3	Autoklavieren	27
36.4	Zentrifugiergefäße	27
37	Störungen	28
38	Sicherungsautomat einschalten	29
39	Reparaturannahme von Zentrifugen	30
40	Entsorgung	30
41	Anhang / Appendix	108
41.1	Rotoren und Zubehör / Rotors and accessories	108
41.1.1	ROTINA 380 / 380 R, Typen / types 1701, 1701-01, 1706, 1706-01	108
41.1.2	ROTINA 380, Typ / type 1701-30	131

1 Bestimmungsgemäße Verwendung

Bei der vorliegenden Maschine handelt es sich um ein Medizinprodukt (Laborzentrifuge) im Sinne der IVD-Richtlinie 98/79/EG. Die Zentrifuge dient zum Trennen von Stoffen bzw. Stoffgemischen mit einer Dichte von max. 1,2 kg/dm³. Darunter fallen auch Stoffe und Stoffgemische menschlichen Ursprungs. Die Zentrifuge ist nur für diesen Verwendungszweck bestimmt. Eine andere oder darüber hinausgehende Benutzung gilt als nicht bestimmungsgemäß. Für hieraus entstehende Schäden haftet die Firma Andreas Hettich GmbH & Co. KG nicht.

Zur bestimmungsgemäßen Verwendung gehört auch das Beachten aller Hinweise aus der Bedienungsanleitung und die Einhaltung der Inspektions- und Wartungsarbeiten.

2 Restrisiken

Die Maschine ist nach dem Stand der Technik und den anerkannten sicherheitstechnischen Regeln gebaut. Bei unsachgemäßer Verwendung und Behandlung können Gefahren für Leib und Leben des Benutzers oder Dritter bzw. Beeinträchtigungen an der Maschine oder an anderen Sachwerten entstehen. Die Maschine ist nur für die bestimmungsgemäße Verwendung, und nur in sicherheitstechnisch einwandfreiem Zustand zu benutzen.

Störungen, die die Sicherheit beeinträchtigen können, sind umgehend zu beseitigen.

3 Technische Daten

Hersteller	Andreas Hettich GmbH & Co. KG D-78532 Tuttlingen				
Modell	ROTINA 380			ROTINA 380 R	
Typ	1701-30	1701	1701-01	1706, 1706-50	1706-01
Netzspannung (± 10%)	200-240 V 1~ / 100-127 V 1~	200-240 V 1~	100-127 V 1~	200-240 V 1~	110-127 V 1~
Netzfrequenz	50 – 60 Hz	50 – 60 Hz	50 – 60 Hz	50 - 60 Hz	60 Hz
Anschlusswert	max. 450 VA	650 VA	700 VA	1300 VA	1400 VA
Stromaufnahme		3.3 A	7.0 A	6.5 A	13.0 A
Kältemittel	----			R 404A	
Kapazität max.	4 x 290 ml				
zulässige Dichte	1.2 kg/dm ³				
Drehzahl (RPM)	4000	15000			
Beschleunigung (RCF)	3095	24400			
Kinetische Energie	6200 Nm	18500 Nm		35000 Nm	
Prüfpflicht (BGR 500)	nein	ja			
Umgebungsbedingungen (EN / IEC 61010-1)	nur in Innenräumen bis zu 2000 m über Normal-Null 2°C bis 35°C 5°C bis 35°C maximale relative Luftfeuchte 80% für Temperaturen bis 31°C, linear abnehmend bis 50% relativer Luftfeuchte bei 40°C.				
– Aufstellungsort					
– Höhe					
– Umgebungstemperatur					
– Luftfeuchtigkeit					
– Überspannungskategorie (IEC 60364-4-443)	II				
– Verschmutzungsgrad	2				
Geräteschutzklasse	I				
nicht für den Einsatz in explosionsgefährdeter Umgebung geeignet.					
EMV					
– Störaussendung, Störfestigkeit	EN / IEC 61326-1, Klasse B; FCC Class B	EN / IEC 61326-1, Klasse B	FCC Class B	EN / IEC 61326-1, Klasse B	FCC Class B
Geräuschpegel (rotorabhängig)	≤ 58 dB(A)	≤ 65 dB(A)		≤ 64 dB(A) ¹⁾	
Abmessungen					
– Breite	457 mm			457 mm	
– Tiefe	600 mm			750 mm	
– Höhe	418 mm			418 mm	
Gewicht	ca. 58.5 kg	ca. 51 kg	ca. 58.5 kg	ca. 81 kg	ca. 88.5 kg

1) bei Rotor 1797 ≤ 70 dB(A)

4 Sicherheitshinweise



Werden nicht alle Hinweise in dieser Bedienungsanleitung befolgt, kann beim Hersteller kein Gewährleistungsanspruch geltend gemacht werden.



- Die Zentrifuge ist so aufzustellen, dass sie standsicher betrieben werden kann.
- Vor Benutzung der Zentrifuge unbedingt den Rotor auf festen Sitz prüfen.
- Während eines Zentrifugationslaufes dürfen sich gemäß EN / IEC 61010-2-020, in einem Sicherheitsbereich von 300 mm um die Zentrifuge herum, keine Personen, Gefahrstoffe und Gegenstände befinden.
- Rotoren, Gehänge und Zubehörteile, die starke Korrosionsspuren oder mechanische Schäden aufweisen, oder deren Verwendungsdauer abgelaufen ist, dürfen nicht mehr verwendet werden.
- Die Zentrifuge darf nicht mehr in Betrieb genommen werden, wenn der Schleuderraum sicherheitsrelevante Schäden aufweist.
- Bei Ausschwingrotoren müssen die Tragzapfen regelmäßig gefettet werden (Hettich-Schmierfett Nr. 4051), um ein gleichmäßiges Ausschwingen der Gehänge zu gewährleisten.

- Vor Inbetriebnahme der Zentrifuge ist die Bedienungsanleitung zu lesen und zu beachten. Nur Personen, die die Bedienungsanleitung gelesen und verstanden haben, dürfen das Gerät bedienen.
- Neben der Bedienungsanleitung und den verbindlichen Regelungen der Unfallverhütung sind auch die anerkannten fachtechnischen Regeln für sicherheits- und fachgerechtes Arbeiten zu beachten. Die Bedienungsanleitung ist um Anweisungen aufgrund bestehender nationaler Vorschriften des Verwenderlandes zur Unfallverhütung und zum Umweltschutz zu ergänzen.
- Die Zentrifuge ist nach dem Stand der Technik gebaut und betriebssicher. Es können aber von ihr Gefahren für den Benutzer oder Dritte ausgehen, wenn sie nicht von geschultem Personal oder unsachgemäß oder zu nicht bestimmungsgemäßem Gebrauch eingesetzt wird.
- Die Zentrifuge darf während des Betriebs nicht bewegt oder angestoßen werden.
- Im Störfall bzw. bei der Notentriegelung nie in den sich drehenden Rotor greifen.
- Um Schäden durch Kondensat zu vermeiden, muss bei Wechsel von einem kalten in einen warmen Raum, die Zentrifuge entweder mindestens 3 Stunden im warmen Raum aufwärmen bevor sie an das Netz angeschlossen werden darf oder 30 Minuten im kalten Raum warmlaufen.
- Es dürfen nur die vom Hersteller für dieses Gerät zugelassenen Rotoren und das zugelassene Zubehör verwendet werden (siehe Kapitel "Anhang/Appendix, Rotoren und Zubehör/Rotors and accessories").
- Der Rotor der Zentrifuge darf nur entsprechend dem Kapitel "Beladen des Rotors" beladen werden.
- Bei der Zentrifugation mit maximaler Drehzahl darf die Dichte der Stoffe oder Stoffgemische $1,2 \text{ kg/dm}^3$ nicht überschreiten.
- Zentrifugationen mit unzulässiger Unwucht sind nicht erlaubt.
- Die Zentrifuge darf nicht in explosionsgefährdeter Umgebung betrieben werden.
- Eine Zentrifugation mit:
 - brennbaren oder explosiven Materialien
 - Materialien, die chemisch mit hoher Energie miteinander reagieren ist verboten.
- Bei der Zentrifugation von gefährlichen Stoffen bzw. Stoffgemischen, die toxisch, radioaktiv oder mit pathogenen Mikroorganismen verseucht sind, sind durch den Benutzer geeignete Maßnahmen zu treffen. Es müssen grundsätzlich Zentrifugiergefäße mit speziellen Schraubverschlüssen für gefährliche Substanzen verwendet werden. Bei Materialien der Risikogruppe 3 und 4 ist zusätzlich zu den verschließbaren Zentrifugiergefäßen ein Bio-Sicherheitssystem zu verwenden (siehe Handbuch "Laboratory Bio-safety Manual" der Weltgesundheitsorganisation).
Bei einem Bio-Sicherheitssystem verhindert eine Bioabdichtung (Dichtring) das Austreten von Tröpfchen und Aerosolen.
Wird das Gehänge eines Bio-Sicherheitssystems ohne den Deckel verwendet, muss der Dichtring vom Gehänge entfernt werden, um eine Beschädigung des Dichtrings während des Zentrifugationslaufes zu vermeiden. Beschädigte Dichtringe dürfen nicht mehr zum Abdichten des Bio-Sicherheitssystems verwendet werden.

Ohne Verwendung eines Bio-Sicherheitssystems ist eine Zentrifuge im Sinne der Norm EN / IEC 61010-2-020 nicht mikrobiologisch dicht.

Lieferbare Bio-Sicherheitssysteme siehe Kapitel "Anhang/Appendix, Rotoren und Zubehör/Rotors and accessories". Im Zweifelsfall sind entsprechende Informationen beim Hersteller einzuholen.

- Der Betrieb der Zentrifuge mit stark korrodierenden Stoffen, welche die mechanische Festigkeit von Rotoren, Gehängen und Zubehörteilen beeinträchtigen können, ist nicht erlaubt.
- Reparaturen dürfen nur von einer vom Hersteller autorisierten Person ausgeführt werden.
- Es dürfen nur Originalersatzteile und zugelassenes Originalzubehör der Firma Andreas Hettich GmbH & Co. KG verwendet werden.
- Es gelten die folgenden Sicherheitsbestimmungen:
EN / IEC 61010-1 und EN / IEC 61010-2-020 sowie deren nationalen Abweichungen.
- Die Sicherheit und Zuverlässigkeit der Zentrifuge ist nur dann gewährleistet, wenn:
 - die Zentrifuge nach der Bedienungsanleitung betrieben wird.
 - die elektrische Installation, am Aufstellungsort der Zentrifuge, den Anforderungen von EN / IEC Festlegungen entspricht.
 - vorgeschriebene Prüfungen nach BGV A1, BGR 500 durch einen Sachkundigen durchgeführt werden.

5 Bedeutung der Symbole



Symbol an der Maschine:

Achtung, allgemeine Gefahrenstelle.

Vor Benutzung der Zentrifuge unbedingt die Bedienungsanleitung lesen und die sicherheitsrelevanten Hinweise beachten!



Symbol in diesem Dokument:

Achtung, allgemeine Gefahrenstelle.

Dieses Symbol kennzeichnet sicherheitsrelevante Hinweise und deutet auf mögliche gefährliche Situationen hin.

Das Nichtbeachten dieser Hinweise kann zu Sach- und Personenschäden führen.



Symbol an der Maschine und in diesem Dokument:

Warnung vor heißer Oberfläche.

Das Nichtbeachten dieses Hinweises kann zu Sach- und Personenschäden führen.



Symbol an der Maschine und in diesem Dokument:

Kunststoff-Nutgehänge dürfen nur bei Temperaturen bis maximal 40°C / 104°F verwendet werden.

Das Nichtbeachten dieses Hinweises kann zu Sach- und Personenschäden führen.



Symbol an der Maschine:

Äquipotential: Steckverbinder (PA-Stecker) für Potentialausgleich (nur bei Zentrifuge mit PA-Stecker).



Symbol an der Maschine:

Schnittstelle RS232 (nur bei Zentrifuge mit Schnittstelle RS232).



Symbol an der Maschine:

Sicherungsautomat (nur bei Typen 1701-01 und 1706-01).



Symbol in diesem Dokument:

Dieses Symbol deutet auf wichtige Sachverhalte hin.



Symbol an der Maschine und in diesem Dokument:

Symbol für die getrennte Sammlung von Elektro- und Elektronikgeräten, gemäß der Richtlinie 2002/96/EG (WEEE). Das Gerät gehört zur Gruppe 8 (Medizinische Geräte).

Verwendung in den Ländern der Europäischen Union sowie in Norwegen und der Schweiz.

6 Lieferumfang

- 1 Anschlusskabel
- 1 Sechskant-Stiftschlüssel 5 mm
- 1 Schmierfett für Tragzapfen
- 1 Bedienungsanleitung
- 1 Hinweisblatt Transportsicherung
- 1 CD (nur bei Typ 1701-30)

Rotor(en) und das entsprechende Zubehör werden je nach Bestellung mitgeliefert.

7 Auspacken der Zentrifuge

- Den Karton nach oben abheben und die Polsterung entfernen.

-  Nicht an der Frontblende anheben.
Das Gewicht der Zentrifuge beachten, siehe Kapitel "Technische Daten".

Die Zentrifuge, mit der angemessenen Anzahl von Helfern, an beiden Seiten anheben und auf den Labortisch stellen.

8 Inbetriebnahme

- Gemäß der Laborgerätenorm EN / IEC 61010-2-020 muss in der Gebäudeinstallation ein Notausschalter zur Trennung der Netzversorgung im Fehlerfall angebracht sein.
Dieser Schalter muss abseits der Zentrifuge angebracht sein, vorzugsweise außerhalb des Raumes, in dem sich die Zentrifuge befindet, oder neben dem Ausgang dieses Raumes.
- **Die Zentrifuge an einem geeigneten Platz standsicher aufstellen und nivellieren. Bei der Aufstellung ist der geforderte Sicherheitsbereich gemäß EN / IEC 61010-2-020, von 300 mm um die Zentrifuge herum, einzuhalten.**

 **Während eines Zentrifugationslaufes dürfen sich gemäß EN / IEC 61010-2-020, in einem Sicherheitsbereich von 300 mm um die Zentrifuge herum, keine Personen, Gefahrstoffe und Gegenstände befinden.**

- Lüftungsöffnungen dürfen nicht zugestellt werden.
Es muss ein Lüftungsabstand von 300 mm um die Lüftungsschlitze oder Lüftungsöffnungen eingehalten werden.
- Zentrifuge mit PA-Stecker:
Bei Bedarf den PA-Stecker an der Rückseite des Gerätes mit einem zusätzlichen medizinischen Potential-Ausgleich-System verbinden.
- Zentrifuge mit Schnittstelle RS232:
Die Schnittstelle RS232 der Zentrifuge mit einem RS232-Verbindungskabel (nicht im Lieferumfang enthalten) an den PC anschließen.
- Prüfen ob die Netzspannung mit der Angabe auf dem Typenschild übereinstimmt.
- Die Zentrifuge mit dem Anschlusskabel an eine genormte Netzsteckdose anschließen. Anschlusswert siehe Kapitel "Technische Daten".
- Den Netzschalter einschalten (Schalterstellung "I"). Die LED's in den Tasten blinken.
Nacheinander erscheinen folgende Anzeigen:
 1. das Zentrifugen-Modell
 2. die Programmversion
 3. der Rotorcode (Rotor), die maximale Drehzahl des Rotors (Nmax) und der voreingestellte Zentrifugerradius (R) des zuletzt durch die Rotorerkennung erkannten Rotors.
 4. **⚡ OPEN ⚡ OEFFNEN**
- Den Deckel öffnen.
Die Zentrifugations-Daten des zuletzt benutzten Programms oder des Programms 1 werden angezeigt.
- Die Transportsicherung entfernen, siehe Hinweisblatt "Transportsicherung".

9 Schnittstelle (nur bei Zentrifuge mit Schnittstelle)

Optional kann das Gerät mit einer Schnittstelle RS232 ausgerüstet werden.

Die Schnittstelle RS232 ist mit dem Symbol  gekennzeichnet.

Über diese Schnittstelle kann die Zentrifuge gesteuert und Daten abgefragt werden.
Die LED in der Taste  leuchtet während der Datenkommunikation.

10 Deckel öffnen und schließen

10.1 Deckel öffnen



Der Deckel lässt sich nur öffnen, wenn die Zentrifuge eingeschaltet ist und der Rotor stillsteht. Sollte dies nicht möglich sein, siehe Kapitel "Notentriegelung".

- Die Taste **OPEN/STOP** drücken. Der Deckel entriegelt motorisch und die linke LED in der Taste **OPEN/STOP** erlischt.

10.2 Deckel schließen



Mit den Fingern nicht zwischen Deckel und Gehäuse greifen.
Den Deckel nicht zuschlagen.

Wenn die linke LED in der Taste **OPEN/STOP** blinkt, die Taste **OPEN/STOP** drücken, dass die motorische Deckelverriegelung die Grundstellung (geöffnet) einnimmt.

- Den Deckel auflegen und die Deckelvorderkante leicht niederdrücken. Die Verriegelung erfolgt motorisch. Die linke LED in der Taste **OPEN/STOP** leuchtet auf.

11 Ein- und Ausbau des Rotors

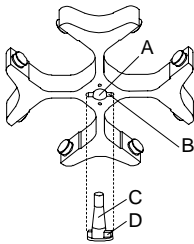

- Die Motorwelle (C) und die Bohrung des Rotors (A) reinigen und anschließend die Motorwelle leicht einfetten. Schmutzpartikel zwischen der Motorwelle und dem Rotor verhindern einen einwandfreien Sitz des Rotors und verursachen einen unruhigen Lauf.
- Den Rotor vertikal auf die Motorwelle aufsetzen. Der Mitnehmer der Motorwelle (D) muss sich in der Nut des Rotors (B) befinden. Auf dem Rotor ist die Ausrichtung der Nut gekennzeichnet.
- Die Spannmutter des Rotors mit dem mitgelieferten Schlüssel durch Drehen im Uhrzeigersinn anziehen.
- Den Rotor auf festen Sitz prüfen.
- Lösen des Rotors: Die Spannmutter durch Drehen entgegen dem Uhrzeigersinn lösen und bis zum Abhebe-Druckpunkt drehen. Nach Überwindung des Abhebe-Druckpunkts löst sich der Rotor vom Konus der Motorwelle. Die Spannmutter drehen, bis sich der Rotor von der Motorwelle abheben lässt.

12 Beladen des Rotors



Standard-ZentrifugiergefäÙe aus Glas sind belastbar bis RZB 4000 (DIN 58970 Teil 2).

- Den Rotor auf festen Sitz prüfen.
- Bei Ausschwingrotoren müssen alle Plätze des Rotors mit **gleichen** Gehängen besetzt sein. Bestimmte Gehänge sind mit der Nummer des Rotorplatzes gekennzeichnet. Diese Gehänge dürfen nur in den entsprechenden Platz des Rotors eingesetzt werden. Gehänge die mit einer Set-Nummer gekennzeichnet sind, z. B. S001/4, dürfen nur im Set verwendet werden.
- Die Rotoren und Gehänge dürfen nur symmetrisch beladen werden. Die ZentrifugiergefäÙe müssen gleichmäÙig auf alle Plätze des Rotors verteilt werden. Zugelassene Kombinationen siehe Kapitel "Anhang/Appendix, Rotoren und Zubehör/Rotors and accessories". Bei Winkelrotoren müssen alle möglichen Plätze des Rotors beladen werden, siehe Kapitel "Anhang/Appendix, Rotoren und Zubehör/Rotors and accessories".

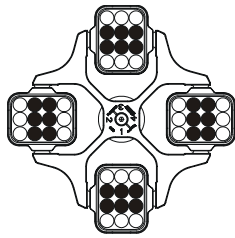

Rotor ist gleichmäÙig beladen

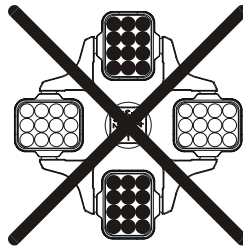

Nicht zulässig!

Rotor ist ungleichmäÙig beladen

- Auf bestimmten Gehängen ist das Gewicht der maximalen Beladung oder das Gewicht der maximalen Beladung und das maximale Gewicht des komplett bestückten Gehänges angegeben. Diese Gewichte dürfen nicht überschritten werden. Im Ausnahmefall siehe Kapitel "Zentrifugation von Stoffen oder Stoffgemischen mit einer höheren Dichte als $1,2 \text{ kg/dm}^3$ ". Die Gewichtsangabe der maximalen Beladung umfasst das Gesamtgewicht von Reduzierung, Gestell, ZentrifugiergefäÙ und Inhalt.
- Bei Behältern mit Gummieinlagen muss sich unter den ZentrifugiergefäÙen immer die gleiche Anzahl von Gummieinlagen befinden.
- Die ZentrifugiergefäÙe immer außerhalb der Zentrifuge befüllen.
- Es darf beim Füllen und beim Ausschwingen der Gehänge keine Flüssigkeit in den Schleuderraum gelangen.
- Die vom Hersteller angegebene maximale Füllmenge der ZentrifugiergefäÙe darf nicht überschritten werden.
- Um die Gewichtsunterschiede innerhalb der ZentrifugiergefäÙe möglichst gering zu halten, ist auf eine gleichmäÙige Füllhöhe in den GefäÙen zu achten.

13 Winkelrotoren aerosoldicht verschließen

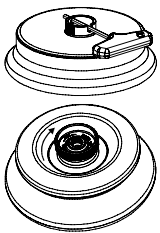

Um Aerosoldichtigkeit zu gewährleisten, muss der Deckel eines aerosoldichten Winkelrotors fest verschlossen werden.

Das geschieht mit Hilfe des mitgelieferten Schlüssels, der durch die Bohrung im Drehgriff gesteckt wird. Besitzt der Drehgriff keine Bohrung, muss der Deckel von Hand, durch Drehen im Uhrzeigersinn, fest verschlossen werden.

Lieferbare aerosoldichte Winkelrotoren siehe Kapitel "Anhang/Appendix, Rotoren und Zubehör/Rotors and accessories".

14 Bedien- und Anzeigeelemente

Siehe Abbildung auf Seite 2.

Fig. 2, Fig. 3: Anzeige- und Bedienfeld

14.1 Drehknopf



Zum Einstellen der einzelnen Parameter.

Drehen entgegen dem Uhrzeigersinn erniedrigt den Wert. Drehen im Uhrzeigersinn erhöht den Wert.

14.2 Tasten und Einstellmöglichkeiten



- Laufzeit, Parameter **t/hms**.
h: Stunden. Einstellbar von 1 h bis 99 h, in 1 Stunden-Schritten.
m: Minuten. Einstellbar von 1 min bis 59 min, in 1 Minuten-Schritten.
s: Sekunden. Einstellbar von 1 s bis 59 s, in 1 Sekunden-Schritten.
- Dauerlauf "∞"



- Drehzahl, Parameter **RPM**.
Einstellbar von 50 RPM bis zur maximalen Drehzahl des Rotors (Nmax), in 10er Schritten. Maximale Drehzahl des Rotors siehe Kapitel "Anhang/Appendix, Rotoren und Zubehör/Rotors and accessories".



- Relative Zentrifugalbeschleunigung, Parameter **RCF**.
Die RCF wird in Klammern $\rangle \langle$ angezeigt. Die LED in der Taste leuchtet.
Einstellbar ist ein Zahlenwert, der eine Drehzahl zwischen 50 RPM und der maximalen Drehzahl des Rotors (Nmax) ergibt. Einstellbar in 1er Schritten.
- Zentrifugerradius, Parameter **RAD**.
Einstellbar von 85 mm bis 330 mm, in 1 Millimeter-Schritten. Zentrifugerradius siehe Kapitel "Anhang/Appendix, Rotoren und Zubehör/Rotors and accessories".





- Anlauf- und Auslauf-Parameter
- Anlaufstufen, Parameter \nearrow .
Stufe 9 = kürzeste Anlaufzeit, ... Stufe 1 = längste Anlaufzeit.
- Bremsstufen, Parameter \searrow .
Stufe 9 = kürzeste Auslaufzeit, ... Stufe 1 = lange Auslaufzeit, Stufe 0 = ungebremster Auslauf.
- Bremsabschaltungs-Drehzahl, Parameter **N Brake**.
Einstellbar von 50 RPM bis zur maximalen Drehzahl des Rotors (Nmax), in 10er Schritten.
Nach Erreichen dieser Drehzahl erfolgt der ungebremste Auslauf.



- Temperatur (nur bei Zentrifuge mit Kühlung)
Einstellbar in Grad Celsius (°C) oder in Grad Fahrenheit (°F). Einstellung der Temperatur-Einheit, siehe Kapitel "Temperatur-Einheit einstellen".
Parameter **T/°C** = Grad Celsius (°C).
Einstellbar von -20°C bis +40°C, in 1°C-Schritten (bei Option Heizen/Kühlen von -20°C bis +90°C einstellbar).
Parameter **T/°F** = Grad Fahrenheit (°F).
Einstellbar von -4°F bis +104°F, in 1°F-Schritten (bei Option Heizen/Kühlen von -4°F bis +194°F einstellbar).
Die tiefste erreichbare Temperatur ist rotorabhängig (siehe Kapitel "Anhang/Appendix, Rotoren und Zubehör/Rotors and accessories").

- 
 - Programme und Programmverknüpfungen abrufen, Parameter **RCL**.
Programme: Programmplätze 1 bis 99 und PREC. Programmverknüpfungen: Programmplätze A bis Z.
 - Programme und Programmverknüpfungen speichern, Parameter **STO**.
Es können 99 Programme gespeichert werden (bei Zentrifuge ohne Kühlung: Programmplätze 1 bis 99, bei Zentrifuge mit Kühlung: Programmplätze 1 bis 98 und PREC). Der Programmplatz PREC (PRECOOLING) ist für das Vorkühlprogramm reserviert. Der Programmplatz 0 dient als Zwischenspeicher, für die Zentrifugations-Daten des zuletzt erfolgten Zentrifugationslaufes. Auf diesem Programmplatz können keine Programme gespeichert werden.
Es können 25 Programmverknüpfungen gespeichert werden (Programmplätze A bis Z, Programmplatz J gibt es nicht). Eine Programmverknüpfung kann aus 20 Programmen bestehen.
 - Programme verknüpfen, Parameter **EDIT**.
 - Das "Machine Menu" aufrufen (die Taste 8 Sekunden gedrückt halten) und in diesem Menü die Parameter auswählen.

- 
 - Vorkühlung des Rotors starten (nur bei Zentrifuge mit Kühlung). Die LED in der Taste leuchtet während des Zentrifugationslaufes, solange sich der Rotor dreht.
Die Vorkühlung des Rotors erfolgt automatisch mit Programm **PREC** (PRECOOLING).

- 
 - Zentrifugationslauf starten. Die LED in der Taste leuchtet während des Zentrifugationslaufes, solange sich der Rotor dreht.
 - Kurzzeitzentrifugation.
Der Zentrifugationslauf erfolgt, solange die Taste gedrückt gehalten wird. Die LED in der Taste leuchtet während des Zentrifugationslaufes, solange sich der Rotor dreht.
 - Eingaben und Änderungen speichern.

- 
 - Zentrifugationslauf beenden.
Der Rotor läuft mit dem vorgewählten Auslauf-Parameter aus. Die rechte LED in der Taste leuchtet bis der Rotor stillsteht. Nach Stillstand des Rotors blinkt die linke LED in der Taste.
Zweimaliges Drücken der Taste löst den NOT-STOP aus.
 - Den Deckel entriegeln.
Die linke LED in der Taste erlischt.
 - Die Parametereingabe und das "Machine Menu" verlassen.

15 Zentrifugations-Parameter eingeben

- 

Wird nach der Anwahl oder während der Eingabe von Parametern 8 Sekunden lang keine Taste gedrückt, werden in der Anzeige wieder die vorherigen Werte angezeigt. Die Eingabe der Parameter muss dann erneut durchgeführt werden.

Bei Eingabe von mehreren Parametern muss die Taste  erst nach der Einstellung des letzten Parameters gedrückt werden.







Werden Parameter verändert, wird die Programmplatz-Nummer in Klammern () angezeigt. Dies bedeutet, dass die Zentrifugations-Daten in der Anzeige nicht mehr mit den gespeicherten Zentrifugations-Daten des Programmplatzes übereinstimmen.

Die Eingabe der Parameter kann jederzeit durch Drücken der Taste  abgebrochen werden. In diesem Fall werden die Einstellungen nicht gespeichert.



15.1 Laufzeit

- 

Um den Dauerlauf einzustellen müssen die Minuten, Sekunden und Stunden auf Null gestellt werden. Der Dauerlauf wird in der Anzeige durch das Symbol "∞" angezeigt.



- Die Taste  drücken. Der Parameter **t/hms** wird angezeigt. Die Minuten (**m**) werden in Klammern **< >** dargestellt, und können verändert werden.
- Mit dem Drehknopf  den gewünschten Wert einstellen.
- Die Taste  drücken. Die Sekunden (**s**) werden in Klammern **< >** dargestellt, und können verändert werden.
- Mit dem Drehknopf  den gewünschten Wert einstellen.
- Die Taste  drücken. Die Stunden (**h**) werden in Klammern **< >** dargestellt, und können verändert werden.
- Mit dem Drehknopf  den gewünschten Wert einstellen.
- Die Taste  drücken, um die Einstellung in die Anzeige zu übernehmen.

15.2 Drehzahl (RPM)

- Die Taste  drücken. Der Parameter **RPM** wird angezeigt.
- Mit dem Drehknopf  den gewünschten Wert einstellen.
- Die Taste  drücken, um die Einstellung in die Anzeige zu übernehmen.



15.3 Relative Zentrifugalbeschleunigung (RCF) und Zentrifugerradius (RAD)

15.3.1 Zentrifugerradius (RAD)

- Die Taste  so oft drücken, bis die Parameter **RAD** und **RCF** angezeigt werden, z. B. **RAD = 146** -> **RCF = 3695**. Die LED in der Taste leuchtet.
- Mit dem Drehknopf  den gewünschten Zentrifugerradius einstellen.
Durch Verändern des Zentrifugerradius passt sich der Wert der RCF automatisch an.
- Die Taste  drücken, um die Einstellung in die Anzeige zu übernehmen.





15.3.2 Relative Zentrifugalbeschleunigung (RCF)

 Die relative Zentrifugalbeschleunigung (RCF) ist vom Zentrifugerradius abhängig. Vor dem Einstellen der RCF muss der Zentrifugerradius eingestellt werden, siehe Kapitel "Zentrifugerradius (RAD)".





- Die Taste  so oft drücken, bis die Parameter **RCF** und **RAD** angezeigt werden, z. B. **RCF = 3695** **RAD = 146**. Die LED in der Taste leuchtet
- Mit dem Drehknopf  die gewünschte RCF einstellen
- Die Taste  drücken, um die Einstellung in die Anzeige zu übernehmen.

15.4 An- und Auslauf-Parameter



15.4.1 Anlaufstufe

- Die Taste  so oft drücken, bis der Parameter  angezeigt wird.
- Mit dem Drehknopf  die gewünschte Stufe einstellen.
- Die Taste  drücken, um die Einstellung in die Anzeige zu übernehmen.

15.4.2 Bremsstufe



- Die Taste  so oft drücken, bis der Parameter  angezeigt wird.
- Mit dem Drehknopf  die gewünschte Stufe einstellen.
- Die Taste  drücken, um die Einstellung in die Anzeige zu übernehmen.

15.4.3 Bremsabschaltungs-Drehzahl

- Die Taste  so oft drücken, bis der Parameter **N Brake** angezeigt wird.
- Mit dem Drehknopf  den gewünschten Wert einstellen.
- Die Taste  drücken, um die Einstellung in die Anzeige zu übernehmen.

15.5 Temperatur (nur bei Zentrifuge mit Kühlung)

 Die Temperatur kann in Grad Celsius (°C) oder in Grad Fahrenheit (°F) eingegeben werden. Einstellung der Temperatur-Einheit siehe Kapitel "Temperatur-Einheit einstellen".









- Die Taste  drücken. Der Parameter **T/°C** bzw. **T/°F** wird angezeigt.
- Mit dem Drehknopf  den gewünschten Wert einstellen.
- Die Taste  drücken, um die Einstellung in die Anzeige zu übernehmen.

16 Programmierung



 Werden Parameter verändert, wird die Programmplatz-Nummer in Klammern () angezeigt. Dies bedeutet, dass die Zentrifugations-Daten in der Anzeige nicht mehr mit den gespeicherten Zentrifugations-Daten des Programmplatzes übereinstimmen.

16.1 Voreingestellte Programme (nur bei Typ 1701-30)

 Die Programme 1 bis 4 sind voreingestellt und schreibgeschützt.
 Beim Versuch Daten auf den Programmplätzen 1 bis 4 zu speichern, wird "**Protected !!**" angezeigt und die Daten werden nicht gespeichert.
 Beim Abrufen des Programms, wird bei den Programmplätzen 1 bis 4 durch "+" angezeigt, dass diese Daten schreibgeschützt sind.
 Wird der Schreibschutz aufgehoben können die Daten der Programmplätze 1 bis 4 geändert und gespeichert werden. Die Speicherung erfolgt jedoch nur temporär, und nach dem Ausschalten des Geräts gehen die geänderten Daten wieder verloren.

PROG 1	PROG 2	PROG 3	PROG 4
RAD 155	RAD 155	RAD 155	RAD 155
RCF 200	RCF 800	RCF 600	RCF 600
RPM 1074	RPM 2149	RPM 1861	RPM 1861
Laufzeit 2:15	Laufzeit 10:15	Laufzeit 10:15	Laufzeit 5:15
 9	 9	 9	 9
 0	 6	 6	 6

16.2 Programme eingeben oder ändern



- Die gewünschten Parameter einstellen (siehe Kapitel "Zentrifugations-Parameter eingeben").
- Die Taste  so oft drücken, bis der Parameter **STO** angezeigt wird.
- Mit dem Drehknopf  den gewünschten Programmplatz einstellen.

 Wird hinter dem Programmplatz ein "+" angezeigt, so sind die Daten schreibgeschützt. In diesem Fall muss zuerst der Schreibschutz aufgehoben werden, bevor gespeichert werden kann (siehe Kapitel "Schreibschutz für Programme").

- Die Taste  drücken, um die Einstellungen auf dem gewünschten Programmplatz zu speichern. Als Bestätigung wird kurzzeitig **Program store ..** angezeigt.

 Die vorherigen Daten des Programmplatzes werden beim Speichern überschrieben.
 Wird "**Protected !!**" angezeigt, sind die Daten auf dem Programmplatz schreibgeschützt und es wird nicht gespeichert.

16.3 Programme abrufen

- Die Taste  drücken. Der Parameter **RCL** wird angezeigt.
- Mit dem Drehknopf  den gewünschten Programmplatz einstellen.





 Wird hinter dem Programmplatz ein "+" angezeigt, so sind die Daten schreibgeschützt.

- Die Taste  drücken. Als Bestätigung wird kurzzeitig **Program recall ..** angezeigt. Die Zentrifugations-Daten des angewählten Programmplatzes werden angezeigt.

16.4 Schreibschutz für Programme

Die Programme können gegen unbeabsichtigtes Ändern geschützt werden.

Der Schreibschutz kann, bei Stillstand des Rotors, wie folgt aktiviert oder deaktiviert werden:

- Das gewünschte Programm abrufen (siehe Kapitel "Programme abrufen").
- Die Taste  drücken. Der Parameter **RCL** wird angezeigt.
- Die Taste  8 Sekunden gedrückt halten.
 Nach 8 Sekunden erscheint z. B. **Set Protection = 1-** in der Anzeige.
- Mit dem Drehknopf  "+" oder "-" einstellen.
 + = Programm ist schreibgeschützt,
 - = Programm ist nicht schreibgeschützt.
- Die Taste  drücken um die Einstellung zu speichern.

16.5 Programmverknüpfung

Mit Hilfe der Programmverknüpfung können mehrere Zentrifugationsläufe miteinander verknüpft werden.



Eine Programmverknüpfung ist nur möglich, wenn diese aktiviert ist (Parameter **Multi programs = on**; siehe Kapitel "Programmverknüpfung aktivieren oder deaktivieren").

16.5.1 Programmverknüpfung aktivieren oder deaktivieren

Die Programmverknüpfung kann, bei Stillstand des Rotors, wie folgt aktiviert oder deaktiviert werden:

- Die Taste **PROG** 8 Sekunden gedrückt halten.
Nach 8 Sekunden erscheint ***** Machine Menu ***** in der Anzeige.
- Die Taste **PROG** so oft drücken bis -> **Settings** angezeigt wird.
- Die Taste **START** drücken. Es wird **SOUND / BELL = off/on** angezeigt.
- Die Taste **PROG** so oft drücken bis **Multi programs = off/on** angezeigt wird.
- Mit dem Drehknopf **OFF** oder **ON** einstellen.
off = Programmverknüpfung deaktiviert,
on = Programmverknüpfung aktiviert.
- Die Taste **START** drücken um die Einstellung zu speichern.
Als Bestätigung wird kurzzeitig **Store Settings ...** und anschließend -> **Settings** angezeigt.
- Die Taste **OPEN/STOP** 1x drücken, um das Menü "Settings" zu verlassen oder die Taste **OPEN/STOP** 2x drücken, um das "Machine Menu" zu verlassen.

16.5.2 Programme verknüpfen oder eine Programmverknüpfung ändern



Es können 25 Programmverknüpfungen gespeichert werden (Programmplätze A bis Z, Programmplatz J gibt es nicht). Eine Programmverknüpfung kann maximal aus 20 Programmen bestehen.

In einer Programmverknüpfung erfolgt die Anpassung der Drehzahl von einem Programm zum nächsten Programm immer mit dem Anlaufparameter des nächsten Programms.

Es dürfen sich in einer Programmverknüpfung keine Dauerlauf-Programme befinden.

In einer Programmverknüpfung können keine Zentrifugations-Parameter geändert werden. Eine Änderung der Parameter ist nur in den einzelnen Programmen möglich.

Mit der Taste **TIME** kann während des Zentrifugationslaufes die Gesamtlaufzeit der Programmverknüpfung (z. B. $\Sigma=00:05:30$) und die Laufzeit des gerade laufenden Programms (z. B. **t B.02=00:01:00**) abgerufen werden.

1. Die Taste **PROG** so oft drücken bis der Parameter **EDIT A...Z** angezeigt wird.
2. Mit dem Drehknopf **OFF** den gewünschten Programmplatz einstellen, auf dem die Programmverknüpfung gespeichert werden soll.
3. Die Taste **START** drücken. Es wird der Programmplatz der Programmverknüpfung und das erste Programm der Programmverknüpfung angezeigt, z. B. **EDIT B.01 = 01**.
4. Mit dem Drehknopf **OFF** das erste Programm der Programmverknüpfung einstellen.
5. Die Taste **PROG** drücken. Das nächste Programm der Programmverknüpfung wird angezeigt, z. B. **EDIT B.02 = END**.
6. Mit dem Drehknopf **OFF** das nächste Programm der Programmverknüpfung einstellen.
7. Die Taste **PROG** drücken. Das nächste Programm der Programmverknüpfung wird angezeigt, z. B. **EDIT B.03 = END**.
8. Die Schritte 6 und 7 so oft wiederholen, bis alle Programme eingestellt sind.
9. Mit dem Drehknopf **OFF** **END** einstellen (Drehknopf entgegen dem Uhrzeigersinn drehen).



Bei Programmverknüpfungen die aus 20 Programmen bestehen kann nach dem 20. Programm kein **END** eingestellt werden.

10. Die Taste **START** drücken. Es wird z. B. **STO B** angezeigt.
11. Die Taste **START** drücken um die Programmverknüpfung zu speichern.
Als Bestätigung wird kurzzeitig **Multi program store ..** angezeigt.

16.5.3 Programmverknüpfung abrufen

- Die Taste **PROG** so oft drücken bis der Parameter **RCL A...Z** angezeigt wird.
- Mit dem Drehknopf **OFF** den gewünschten Programmplatz einstellen.
- Die Taste **START** drücken. Als Bestätigung wird kurzzeitig **Multi program recall ..** angezeigt.
Die Zentrifugations-Daten des ersten Programms der Programmverknüpfung werden angezeigt.

16.6 Automatischer Zwischenspeicher

Der Programmplatz 0 dient als Zwischenspeicher für die Zentrifugations-Daten des zuletzt erfolgten Zentrifugationslaufes.

Auf diesem Programmplatz können keine Programme gespeichert werden.

Nach jedem Start eines Zentrifugationslaufes werden die zum Lauf verwendeten Zentrifugations-Daten automatisch auf Programmplatz "0" gespeichert und können abgerufen werden.

17 Zentrifugation



Während eines Zentrifugationslaufes dürfen sich gemäß EN / IEC 61010-2-020, in einem Sicherheitsbereich von 300 mm um die Zentrifuge herum, keine Personen, Gefahrstoffe und Gegenstände befinden.



Wird der zulässige Gewichtsunterschied innerhalb der Beladung des Rotors überschritten, schaltet der Antrieb während des Anlaufs ab, und **IMBALANCE** wird angezeigt.

Ist die Drehzahl im angewählten Programm höher als die maximale Drehzahl des Rotors (Nmax), kann kein Zentrifugationslauf gestartet werden. Es wird **N > ROTOR MAX** angezeigt (siehe Kapitel "Störungen").

Wird bei Programmverknüpfungen **N > ROTOR MAX in Prog** : z. B. **5, Runtime 00:00 in Prog** : z. B. **5** oder **Empty Program** angezeigt, kann kein Zentrifugationslauf gestartet werden (siehe Kapitel "Störungen").

Ein Zentrifugationslauf kann jederzeit durch Drücken der Taste **OPEN/STOP** abgebrochen werden.

Während des Zentrifugationslaufes können alle Parameter angewählt und geändert werden (siehe Kapitel "Zentrifugations-Parameter eingeben").

Mit den Tasten **RPM** und **RCF** kann jederzeit zwischen der RPM- und RCF-Anzeige umgeschaltet werden. Eine Umschaltung ist nicht möglich, wenn mit Programmverknüpfungen gearbeitet wird. Wird mit der RCF-Anzeige gearbeitet, ist die Eingabe des Zentrifugerradius notwendig.

Wird **OPEN OEFFNEN** angezeigt, so ist eine weitere Bedienung der Zentrifuge erst nach einmaligem Öffnen des Deckels möglich.

Wurde der Rotor gewechselt, findet kein Zentrifugationslauf statt, und es erscheint die Anzeige z. B. **Rotor 4 Nmax= 4500 R=184 mm** (siehe Kapitel "Rotor-Erkennung").

Bedienfehler und Störungen werden angezeigt (siehe Kapitel "Störungen").

- Den Netzschalter einschalten. Schalterstellung I.
- Den Rotor beladen und den Zentrifugendeckel schließen.

17.1 Zentrifugation mit Zeitvorwahl

- Eine Laufzeit einstellen, ein Programm mit Zeitvorwahl oder eine Programmverknüpfung abrufen (siehe Kapitel "Zentrifugations-Parameter eingeben", "Programme abrufen" oder "Programmverknüpfung").
- Die Taste **START** drücken. Die LED in der Taste **START** blinkt bis der Rotor eingelesen ist, anschließend leuchtet die LED.
- Nach Ablauf der Zeit oder bei Abbruch des Zentrifugationslaufes durch Drücken der Taste **OPEN/STOP**, erfolgt der Auslauf mit dem angewählten Auslauf-Parameter. Der Auslauf-Parameter wird angezeigt z. B. **9**. Die rechte LED in der Taste **OPEN/STOP** leuchtet auf. Nach Stillstand des Rotors erlischt die LED in der Taste **START** und **OPEN OEFFNEN** wird angezeigt. Die rechte LED in der Taste **OPEN/STOP** erlischt ebenfalls, die linke LED in der Taste **OPEN/STOP** beginnt zu blinken und blinkt bis der Deckel geöffnet wird.

Während des Zentrifugationslaufes werden die Drehzahl des Rotors oder der daraus resultierende RCF-Wert, die Proben-Temperatur (nur bei Zentrifuge mit Kühlung), und die verbleibende Zeit angezeigt.

17.2 Dauerlauf

- Die Minuten, Sekunden und Stunden auf "0" stellen oder ein Dauerlauf-Programm abrufen (siehe Kapitel "Zentrifugations-Parameter eingeben" oder "Programme abrufen").
- Die Taste **START** drücken. Die LED in der Taste **START** blinkt bis der Rotor eingelesen ist, anschließend leuchtet die LED. Die Zeitzählung beginnt bei 00:00.
- Die Taste **OPEN/STOP** drücken, um den Zentrifugationslauf zu beenden. Der Auslauf erfolgt mit dem angewählten Auslauf-Parameter. Der Auslauf-Parameter wird angezeigt z. B. **9**. Die rechte LED in der Taste **OPEN/STOP** leuchtet auf. Nach Stillstand des Rotors erlischt die LED in der Taste **START** und **OPEN OEFFNEN** wird angezeigt. Die rechte LED in der Taste **OPEN/STOP** erlischt ebenfalls, die linke LED in der Taste **OPEN/STOP** beginnt zu blinken und blinkt bis der Deckel geöffnet wird.

Während des Zentrifugationslaufes werden die Drehzahl des Rotors oder der daraus resultierende RCF-Wert, die Proben-Temperatur (nur bei Zentrifuge mit Kühlung), und die gelaufene Zeit angezeigt.

17.3 Kurzzeitzentrifugation



Eine Kurzzeitzentrifugation ist nicht möglich, wenn mit Programmverknüpfungen gearbeitet wird.

- Die Taste **START** gedrückt halten. Die LED in der Taste **START** blinkt bis der Rotor eingelesen ist, anschließend leuchtet die LED. Die Zeitzählung beginnt bei 00:00.
- Die Taste **START** wieder loslassen um den Zentrifugationslauf zu beenden. Der Auslauf erfolgt mit dem angewählten Auslauf-Parameter. Der Auslauf-Parameter wird angezeigt z. B. **9**. Die rechte LED in der Taste **OPEN/STOP** leuchtet auf. Nach Stillstand des Rotors erlischt die LED in der Taste **START** und **OPEN** **OFFNEN** wird angezeigt. Die rechte LED in der Taste **OPEN/STOP** erlischt ebenfalls, die linke LED in der Taste **OPEN/STOP** beginnt zu blinken und blinkt bis der Deckel geöffnet wird.

Während des Zentrifugationslaufes werden die Drehzahl des Rotors oder der daraus resultierende RCF-Wert, die Proben-Temperatur (nur bei Zentrifuge mit Kühlung), und die gelaufene Zeit angezeigt.

18 Einstellungen während des Zentrifugationslaufes ändern



Es ist nicht möglich Einstellungen während des Zentrifugationslaufes zu ändern, wenn mit Programmverknüpfungen gearbeitet wird.

Die Laufzeit, die Drehzahl, die Relative Zentrifugalbeschleunigung (RCF), der Zentrifugerradius, die Anlauf- und Auslauf-Parameter sowie die Temperatur (nur bei Zentrifuge mit Kühlung) können während des Zentrifugationslaufes verändert werden.

- Den gewünschten Parameter anwählen und mit dem Drehknopf **○** den Wert verändern (siehe Kapitel "Zentrifugations-Parameter eingeben").
- Die Taste **START** drücken. Die geänderte Einstellung wird auf Programmplatz "0" gespeichert (siehe Kapitel "Automatischer Zwischenspeicher"). Die Programmplatz-Nummer wird in Klammern () angezeigt. Das originale Programm wird nicht überschrieben.

19 Not-Stop

- Die Taste **OPEN/STOP** 2x drücken.

Beim Not-Stop erfolgt der Auslauf mit Bremsstufe 9 (kürzeste Auslaufzeit). Die Bremsstufe **9** wird angezeigt. War die Bremsstufe 0 vorgewählt, so erfolgt der Auslauf mit Bremsstufe **9d**. Mit Bremsstufe **9d** ist die Auslaufzeit technisch bedingt länger als mit Bremsstufe 9.

20 Akustisches Signal

Das akustische Signal ertönt:

- bei Auftreten einer Störung im 2 s-Intervall.
- nach Beendigung des Zentrifugationslaufes und Stillstand des Rotors im 30 s-Intervall.

Durch Öffnen des Deckels oder Drücken einer beliebigen Taste wird das akustische Signal beendet.

Das Signal nach Beendigung des Zentrifugationslaufes kann, bei Stillstand des Rotors, folgendermaßen aktiviert oder deaktiviert werden:

- Die Taste **PROG** 8 Sekunden gedrückt halten.
Nach 8 Sekunden erscheint ***** Machine Menu ***** in der Anzeige.
- Die Taste **PROG** so oft drücken bis -> **Settings** angezeigt wird.
- Die Taste **START** drücken. Es wird **SOUND / BELL = off/on** angezeigt.
- Mit dem Drehknopf **○** **off** (aus) oder **on** (ein) einstellen.
- Die Taste **START** drücken um die Einstellung zu speichern.
Als Bestätigung wird kurzzeitig **Store Settings ...** und anschließend -> **Settings** angezeigt.
- Die Taste **OPEN/STOP** 1x drücken, um das Menü "Settings" zu verlassen oder die Taste **OPEN/STOP** 2x drücken, um das "Machine Menu" zu verlassen.

21 Angezeigte Zentrifugations-Daten nach dem Einschalten

Nach dem Einschalten werden die Zentrifugations-Daten des Programms 1, oder die des zuletzt benutzten Programms angezeigt.

Dies kann, bei Stillstand des Rotors, wie folgt eingestellt werden:

- Die Taste **PROG** 8 Sekunden gedrückt halten.
Nach 8 Sekunden erscheint ***** Machine Menu ***** in der Anzeige.
- Die Taste **PROG** so oft drücken bis -> **Settings** angezeigt wird.
- Die Taste **START** drücken. Es wird **SOUND / BELL = off/on** angezeigt.
- Die Taste **PROG** so oft drücken bis **Start program = Last/First** angezeigt wird.
- Mit dem Drehknopf **○ Last** oder **First** einstellen.
Last = zuletzt benutztes Programm, First = Programm 1.
- Die Taste **START** drücken um die Einstellung zu speichern.
Als Bestätigung wird kurzzeitig **Store Settings ...** und anschließend -> **Settings** angezeigt.
- Die Taste **OPEN/STOP** 1x drücken, um das Menü "Settings" zu verlassen oder die Taste **OPEN/STOP** 2x drücken, um das "Machine Menu" zu verlassen.

22 Temperatur-Einheit einstellen (nur bei Zentrifuge mit Kühlung)

Die Temperatur kann in Grad Celsius (°C) oder in Grad Fahrenheit (°F) eingegeben werden.

Dazu muss die Temperatur-Einheit, bei Stillstand des Rotors, wie folgt eingestellt werden:

- Die Taste **PROG** 8 Sekunden gedrückt halten.
Nach 8 Sekunden erscheint ***** Machine Menu ***** in der Anzeige.
- Die Taste **PROG** so oft drücken bis -> **Settings** angezeigt wird.
- Die Taste **START** drücken. Es wird **SOUND / BELL = off/on** angezeigt.
- Die Taste **PROG** so oft drücken bis **Temp Unit = Celsius/Fahrenheit** angezeigt wird.
- Mit dem Drehknopf **○ Celsius** oder **Fahrenheit** einstellen.
- Die Taste **START** drücken um die Einstellung zu speichern.
Als Bestätigung wird kurzzeitig **Store Settings ...** und anschließend -> **Settings** angezeigt.
- Die Taste **OPEN/STOP** 1x drücken, um das Menü "Settings" zu verlassen oder die Taste **OPEN/STOP** 2x drücken, um das "Machine Menu" zu verlassen.

23 Programm-Verriegelung einstellen

Bei Stillstand des Rotors können folgende Programm-Verriegelungen eingestellt werden::

LOCK 1 **LOCK 1** wird im Feld "" angezeigt.

Programme können nur abgerufen, jedoch nicht verändert werden.

LOCK 2 **LOCK 2** wird im Feld "" angezeigt.

Es können keine Programme abgerufen und verändert werden.

Die Zentrifuge kann über die Schnittstelle gesteuert werden (nur bei Zentrifuge mit Schnittstelle).

LOCK 3 keine Status-Anzeige.

Keine Programm-Verriegelung. Programme können abgerufen und geändert werden.

- Die Taste **PROG** 8 Sekunden gedrückt halten.
Nach 8 Sekunden erscheint ***** Machine Menu ***** in der Anzeige.
- Die Taste **PROG** so oft drücken bis -> **Change LOCK** angezeigt wird.
- Die Taste **START** drücken. Es wird der Lock-Status angezeigt.
Ist keine PIN eingegeben, wird z. B. **LOCK = {3} confirm by START** angezeigt.
Ist eine PIN eingegeben, wird z. B. **LOCK = 3** angezeigt.
- Mit dem Drehknopf **○** den gewünschten Lock-Status einstellen.



Ist eine PIN eingegeben, wird **PIN = ---- confirm by START** angezeigt. In diesem Fall muss zuerst mit dem Drehknopf **○** die gültige PIN eingestellt, und anschließend die Taste **START** gedrückt werden, bevor der Lock-Status eingestellt werden kann.

- Die Taste **START** drücken um die Einstellung zu speichern.
Als Bestätigung wird kurzzeitig z. B. **Store LOCK 2 ...** und anschließend -> **Change LOCK** angezeigt.
- Die Taste **OPEN/STOP** 1x drücken, um das Menü "Change LOCK" zu verlassen oder die Taste **OPEN/STOP** 2x drücken, um das "Machine Menu" zu verlassen.

24 PIN (Persönliche Identifikationsnummer)

Um das Ändern der Programm-Verriegelung durch unberechtigte Personen zu verhindern, kann eine PIN eingestellt werden.

 Ab Werk ist keine PIN eingestellt.

24.1 PIN einstellen oder ändern

Die PIN kann, bei Stillstand des Rotors, wie folgt eingestellt werden:

- Die Taste **[PROG]** 8 Sekunden gedrückt halten.
Nach 8 Sekunden erscheint ***** Machine Menu ***** in der Anzeige.
- Die Taste **[PROG]** so oft drücken bis -> **Change PIN** angezeigt wird.
- Die Taste **[START]** drücken. Es wird **old PIN = ---- <START>** angezeigt.
- Mit dem Drehknopf **○** die gültige PIN einstellen.

 Wird die PIN zum ersten Mal eingestellt, dann diesen Schritt überspringen, oder "0000" einstellen.

Eingabehilfe:

Die jeweilige Taste gedrückt halten.

[1000] : nur die 1000er Stelle der PIN wird verändert.

[RCF] : nur die 100er Stelle der PIN wird verändert.

[RPM] : nur die 10er Stelle der PIN wird verändert.

[TIME] : nur die 1er Stelle der PIN wird verändert.

- Die Taste **[START]** drücken. Es wird **new PIN = ---- <START>** angezeigt.

 Wurde eine falsche PIN eingestellt, wird wieder **old PIN = ---- <START>** angezeigt. In diesem Fall mit dem Drehknopf **○** die gültige PIN einstellen, und anschließend die Taste **[START]** drücken.

- Mit dem Drehknopf **○** die neue PIN einstellen.

 Zum Löschen der PIN muss "0000" eingestellt werden.

- Die Taste **[START]** drücken um die Einstellung zu speichern.
Als Bestätigung wird kurzzeitig **Store PIN ...** und anschließend -> **Change PIN** angezeigt.
- Die Taste **[OPEN/STOP]** 1x drücken, um das Menü "Change PIN" zu verlassen oder die Taste **[OPEN/STOP]** 2x drücken, um das "Machine Menu" zu verlassen.

24.2 Vergessene PIN ändern

Wurde die PIN vergessen, kann eine sogenannte Help-Zahl abgerufen werden. Mit Hilfe dieser Zahl kann der Hersteller eine PIN errechnen, mit der die vergessene PIN geändert werden kann. Im Bedarfsfall wenden Sie sich bitte an Ihren Lieferanten.

- Die Taste **[PROG]** 8 Sekunden gedrückt halten.
Nach 8 Sekunden erscheint ***** Machine Menu ***** in der Anzeige.
- Die Taste **[PROG]** so oft drücken bis -> **Change PIN** angezeigt wird.
- Die Taste **[START]** drücken. Es wird **old PIN = ---- <START>** angezeigt.
- Die Taste **[PROG]** drücken. Es wird **Get HELP # no** angezeigt.
- Mit dem Drehknopf **○** **yes** einstellen.
- Die Taste **[START]** drücken. Es wird **Are you sure ? no** angezeigt.
- Mit dem Drehknopf **○** **yes** einstellen.
- Die Taste **[START]** drücken. Es wird die Help-Zahl angezeigt, z. B. **HELP # = 5487**.
- Diese Help-Zahl notieren und damit die benötigte PIN anfordern.
- Mit Hilfe der erhaltenen PIN eine neue PIN einstellen (siehe Kapitel "PIN einstellen oder ändern").

25 Adresse der Zentrifuge

 Die Adresse ist ab Werk auf] = 29. Adresse eingestellt.

26 Funktionen RCF-Integral und B-Ramp

 Diese Funktionen sind standardmäßig nicht aktiviert.

27 Abfrage der Betriebsstunden und der Anzahl der Zentrifugationsläufe

Die Betriebsstunden sind in interne und externe Betriebsstunden aufgeteilt.

Interne Betriebsstunden: Gesamte Zeit, die das Gerät eingeschaltet war.

Externe Betriebsstunden: Gesamte Zeit der bisherigen Zentrifugationsläufe.

Die Betriebsstunden und die Anzahl der Zentrifugationsläufe können, bei Stillstand des Rotors, wie folgt abgefragt werden:

- Die Taste **PROG** 8 Sekunden gedrückt halten.
Nach 8 Sekunden erscheint ***** Machine Menu ***** in der Anzeige.
- Die Taste **PROG** so oft drücken bis -> **Operating Time** angezeigt wird.
- Die Taste **START** drücken. Es werden die externen Betriebsstunden angezeigt, z. B. **OP Time ext = 0h25m**.
- Die Taste **PROG** drücken. Es werden die internen Betriebsstunden angezeigt, z. B. **OP Time int = 1h36m**.
- Die Taste **PROG** drücken. Es wird die Anzahl der Zentrifugationsläufe angezeigt, z. B. **Number of Starts = 10**.
- Die Taste **OPEN/STOP** 2x drücken, um das Menü "Operating Time" zu verlassen oder die Taste **OPEN/STOP** 3x drücken, um das "Machine Menu" zu verlassen.

28 Abfrage von System-Informationen

Die Rotor-Informationen und die Programmversion der Zentrifuge und des Frequenzumrichters können, bei Stillstand des Rotors, wie folgt abgefragt werden:

- Die Taste **PROG** 8 Sekunden gedrückt halten.
Nach 8 Sekunden erscheint ***** Machine Menu ***** in der Anzeige.
- Die Taste **PROG** so oft drücken bis -> **Info** angezeigt wird.
- Die Taste **START** drücken. Es werden der Rotorcode (Rotor), die maximale Drehzahl des Rotors (Nmax) und der voreingestellte Zentrifugerradius (R) des zuletzt durch die Rotorerkennung erkannten Rotors angezeigt, z. B. **Rotor 4* : Nmax = 4500 R=184**.
Der zuletzt erkannte Rotor ist mit einem Stern (*) gekennzeichnet. Mit dem Drehknopf **○** können nun die Informationen der in der Zentrifuge zugelassenen Rotoren angezeigt werden.
- Die Taste **PROG** drücken. Es wird die Programmversion der Zentrifuge angezeigt, z. B. **SW-Version = 01.00**.
- Die Taste **PROG** drücken. Es wird die Programmversion des Frequenzumrichters angezeigt, z. B. **FC-SW-Version = 4**.
- Die Taste **OPEN/STOP** 2x drücken, um das Menü "Info" zu verlassen oder die Taste **OPEN/STOP** 3x drücken, um das "Machine Menu" zu verlassen.

29 Sofortige Anzeige der Zentrifugations-Daten nach dem Einschalten

- Den Netzschalter einschalten. (Schalterstellung **I**).
- Bei der ersten optischen Änderung in der Anzeige (inverse Anzeige) eine beliebige Taste drücken und gedrückt halten. Die Zentrifugations-Daten werden sofort angezeigt.

30 Kühlung (nur bei Zentrifuge mit Kühlung)

Die Temperatur kann von -20°C bis +40°C / -4°F bis +104°F eingestellt werden. Bei Zentrifugen mit Option Heizen/Kühlen ist die Temperatur von -20°C bis +90°C / -4°F bis +194°F einstellbar. Die tiefste erreichbare Temperatur ist rotorabhängig (siehe Kapitel "Anhang/Appendix, Rotoren und Zubehör/Rotors and accessories").

30.1 Standby-Kühlung

Bei Stillstand des Rotors und geschlossenem Deckel wird der Schleuderraum auf die vorgewählte Temperatur gekühlt, wenn diese niedriger als 20°C / 68°F ist.

Während der Standby-Kühlung wird die vorgewählte Temperatur angezeigt.

30.2 Vorkühlen des Rotors



Zum schnellen Vorkühlen des unbeladenen Rotors und des Zubehörs, empfiehlt sich ein Zentrifugationslauf mit den Einstellungen Dauerlauf und einer Drehzahl von ca. 20% der maximalen Drehzahl des Rotors. Die Vorkühlung erfolgt automatisch mit Programm **PREC** (PRECOOLING). Eine Vorkühlung ist nicht möglich, wenn mit Programmverknüpfungen gearbeitet wird.

- Die Taste drücken. Die LED in der Taste blinkt bis der Rotor eingelesen ist, anschließend leuchtet die LED.
- Nach Ablauf der Zeit oder bei Abbruch des Zentrifugationslaufes durch Drücken der Taste , erfolgt der Auslauf mit dem angewählten Auslauf-Parameter. Der Auslauf-Parameter wird angezeigt z. B. ~ 9 . Die rechte LED in der Taste leuchtet auf. Nach Stillstand des Rotors erlischt die LED in der Taste und **OPEN** **OEFFNEN** wird angezeigt. Die rechte LED in der Taste erlischt ebenfalls, die linke LED in der Taste beginnt zu blinken und blinkt bis der Deckel geöffnet wird.

Während des Zentrifugationslaufes werden die Drehzahl des Rotors oder der daraus resultierende RCF-Wert, die Proben-Temperatur, und die verbleibende oder die gelaufene Zeit angezeigt.

31 Heizung (nur bei Zentrifuge mit Option Heizen/Kühlen)

Während des Zentrifugationslaufes wird bei Bedarf der Schleuderraum auf die vorgewählte Temperatur geheizt. Bei Stillstand des Rotors ist die Heizung ausgeschaltet.



Verbrennungsgefahr! Die Oberflächen-Temperatur des Heizelements im Schleuderraum der Zentrifuge kann bis zu 500°C / 932°F betragen. Das Heizelement nicht berühren.



Kunststoff-Nutgehänge dürfen nur bei Temperaturen bis maximal 40°C / 104°F verwendet werden.

32 Relative Zentrifugalbeschleunigung (RCF)

Die relative Zentrifugalbeschleunigung (RCF) wird als Vielfaches der Erdbeschleunigung (g) angegeben. Sie ist ein einheitsfreier Zahlenwert und dient zum Vergleich der Trenn- und Sedimentationsleistung.

Die Berechnung erfolgt nach der Formel:

$$\text{RCF} = \left(\frac{\text{RPM}}{1000} \right)^2 \times r \times 1,118 \quad \Rightarrow \quad \text{RPM} = \sqrt{\frac{\text{RCF}}{r \times 1,118}} \times 1000$$

RCF = Relative Zentrifugalbeschleunigung

RPM = Drehzahl

r = Zentrifugerradius in mm = Abstand von der Mitte der Drehachse bis zum Zentrifugiergefäßboden.
Zentrifugerradius siehe Kapitel "Anhang/Appendix, Rotoren und Zubehör/Rotors and accessories".



Die relative Zentrifugalbeschleunigung (RCF) ist von der Drehzahl und dem Zentrifugerradius abhängig.

33 Zentrifugation von Stoffen oder Stoffgemischen mit einer höheren Dichte als 1,2 kg/dm³

Bei der Zentrifugation mit maximaler Drehzahl darf die Dichte der Stoffe oder Stoffgemische 1,2 kg/dm³ nicht überschreiten.

Bei Stoffen oder Stoffgemischen mit einer höheren Dichte muss die Drehzahl reduziert werden.

Die erlaubte Drehzahl lässt sich nach folgender Formel berechnen:

$$\text{Reduzierte Drehzahl (n}_{\text{red}}) = \sqrt{\frac{1,2}{\text{höhere Dichte [kg/dm}^3]}} \times \text{maximale Drehzahl [RPM]}$$

z.B.: Maximale Drehzahl 4000 RPM, Dichte 1,6 kg/dm³

$$n_{\text{red}} = \sqrt{\frac{1,2 \text{ kg/dm}^3}{1,6 \text{ kg/dm}^3}} \times 4000 \text{ RPM} = 3464 \text{ RPM}$$

Wird im Ausnahmefall die, auf dem Gehänge angegebene, maximale Beladung überschritten, muss die Drehzahl ebenfalls reduziert werden.

Die erlaubte Drehzahl lässt sich nach folgender Formel berechnen:

$$\text{Reduzierte Drehzahl (n}_{\text{red}}) = \sqrt{\frac{\text{maximale Beladung [g]}}{\text{tatsächliche Beladung [g]}}} \times \text{maximale Drehzahl [RPM]}$$

z.B.: Maximale Drehzahl 4000 RPM, maximale Beladung 300 g, tatsächliche Beladung 350 g



$$n_{\text{red}} = \sqrt{\frac{300 \text{ g}}{350 \text{ g}}} \times 4000 \text{ RPM} = 3703 \text{ RPM}$$

Bei eventuellen Unklarheiten ist Auskunft beim Hersteller einzuholen.

34 Rotor-Erkennung

Nach jedem Start eines Zentrifugationslaufes wird der eingesetzte Rotor erkannt.

Nach einem Rotorwechsel schaltet der Antrieb ab und der Rotorcode (Rotor), die maximale Drehzahl des Rotors (N_{max}) und der voreingestellte Zentrifugerradius (R) des eingesetzten Rotors werden angezeigt, z. B. **Rotor 4 N_{max}= 4500 R=184 mm**.

- Die Taste  drücken um den Deckel zu öffnen, oder die Taste  drücken um den Zentrifugationslauf zu starten. Bei Zentrifugen mit Kühlung kann auch durch Drücken der Taste  die Vorkühlung des Rotors gestartet werden.



Wenn nach einem Rotorwechsel die maximale Drehzahl des Rotors kleiner als die eingestellte Drehzahl ist, wird die Drehzahl auf die maximale Drehzahl des Rotors begrenzt. In diesem Fall wird die Programmplatz-Nummer in Klammern () angezeigt.



35 Notentriegelung

Bei einem Stromausfall kann der Deckel nicht motorisch entriegelt werden. Es muss eine Notentriegelung von Hand durchgeführt werden.



Zur Notentriegelung die Zentrifuge vom Netz trennen.
Den Deckel nur bei Stillstand des Rotors öffnen.

Siehe Abbildung auf Seite 2.

- Den Netzschalter ausschalten (Schalterstellung "0").
- Durch das Fenster im Deckel schauen, um sich zu vergewissern, dass der Rotor stillsteht.
- Den Sechskant-Stiftschlüssel waagrecht in die Bohrung (Fig. 1, A) einführen und vorsichtig eine halbe Umdrehung im Uhrzeigersinn drehen, bis sich der Deckel öffnen lässt.
- Den Sechskant-Stiftschlüssel wieder aus der Bohrung herausziehen.
- Wenn nach dem Wiedereinschalten der Zentrifuge die linke LED in der Taste  blinkt, die Taste  drücken, dass die motorische Deckelverriegelung wieder die Grundstellung (geöffnet) einnimmt.

36 Pflege und Wartung



Vor der Reinigung den Netzstecker ziehen.

Bevor ein anderes als das vom Hersteller empfohlene Reinigungs- oder Dekontaminationsverfahren angewandt wird, hat sich der Benutzer beim Hersteller zu vergewissern, dass das vorgesehene Verfahren das Gerät nicht schädigt.

- Zentrifugen, Rotoren und das Zubehör dürfen nicht in Spülmaschinen gereinigt werden.
- Es darf nur eine Handreinigung und eine Flüssig-Desinfektion durchgeführt werden.
- Die Wassertemperatur muss 20 – 25°C betragen.
- Es dürfen nur Reinigungs- oder Desinfektionsmittel verwendet werden, die:
 - im pH-Bereich 5 - 8 liegen,
 - keine Ätzalkalien, Peroxide, Chlorverbindungen, Säuren und Laugen enthalten.
- Um Korrosionserscheinungen durch Reinigungs- oder Desinfektionsmittel zu vermeiden sind die speziellen Anwendungshinweise vom Hersteller des Reinigungs- oder Desinfektionsmittels unbedingt zu beachten.

36.1 Zentrifuge (Gehäuse, Deckel und Schleuderraum)

36.1.1 Oberflächenreinigung und -pflege

- Das Gehäuse der Zentrifuge und den Schleuderraum regelmäßig säubern und bei Bedarf mit Seife oder einem milden Reinigungsmittel und einem feuchten Tuch reinigen. Dies dient zum einen der Hygiene und es verhindert Korrosion durch anhaftende Verunreinigungen.
- Inhaltsstoffe geeigneter Reinigungsmittel:
Seife, anionische Tenside, nichtionische Tenside.
- Nach dem Einsatz von Reinigungsmitteln, die Reste des Reinigungsmittels, durch Nachwischen mit einem feuchten Tuch, entfernen.
- Die Flächen müssen unmittelbar nach der Reinigung getrocknet werden.
- Bei Bildung von Kondenswasser den Schleuderraum, durch Auswischen mit einem saugfähigen Tuch, trocknen.
- Die Gummidichtung des Schleuderraums nach jeder Reinigung mit Talkum-Puder oder einem Gummi-Pflegemittel leicht einreiben.
- Der Schleuderraum ist jährlich auf Schäden zu überprüfen.



Werden sicherheitsrelevante Schäden festgestellt, darf die Zentrifuge nicht mehr in Betrieb genommen werden. In diesem Fall ist der Kundendienst zu benachrichtigen.

36.1.2 Oberflächendesinfektion

- Gelangt infektiöses Material in den Schleuderraum, so ist dieser umgehend zu desinfizieren.
- Inhaltsstoffe geeigneter Desinfektionsmittel:
Äthanol, n-Propanol, Isopropanol, Glutardialdehyd, quaternäre Ammoniumverbindungen.
- Nach dem Einsatz von Desinfektionsmitteln, die Reste des Desinfektionsmittels, durch Nachwischen mit einem feuchten Tuch, entfernen.
- Die Flächen müssen unmittelbar nach der Desinfektion getrocknet werden.

36.1.3 Entfernen radioaktiver Verunreinigungen

- Das Mittel muss speziell für das Entfernen radioaktiver Verunreinigungen ausgewiesen sein.
- Inhaltsstoffe geeigneter Mittel für das Entfernen radioaktiver Verunreinigungen:
Anionische Tenside, nichtionische Tenside, polyhydrierter Äthanol.
- Nach dem Entfernen der radioaktiven Verunreinigungen, die Reste des Mittels, durch Nachwischen mit einem feuchten Tuch, entfernen.
- Die Flächen müssen unmittelbar nach dem Entfernen der radioaktiven Verunreinigungen getrocknet werden.

36.2 Rotoren und Zubehör

36.2.1 Reinigung und Pflege

- Um einer Korrosion und Materialveränderungen vorzubeugen müssen die Rotoren und die Zubehörteile regelmäßig mit Seife oder einem milden Reinigungsmittel und einem feuchten Tuch gereinigt werden. Die Reinigung wird mindestens einmal wöchentlich empfohlen. Verschmutzungen müssen sofort entfernt werden.
- Inhaltsstoffe geeigneter Reinigungsmittel:
Seife, anionische Tenside, nichtionische Tenside.
- Nach dem Einsatz von Reinigungsmitteln, die Reste des Reinigungsmittels, durch Nachspülen mit Wasser (nur außerhalb der Zentrifuge) oder Nachwischen mit einem feuchten Tuch, entfernen.
- Die Rotoren und das Zubehör müssen unmittelbar nach der Reinigung getrocknet werden.
- Winkelrotoren, Behälter und Gehänge aus Aluminium sind nach dem Trocknen mit säurefreiem Fett z.B. Vaseline leicht einzufetten.
- Bei Bio-Sicherheitssystemen (lieferbare Bio-Sicherheitssysteme siehe Kapitel "Anhang/Appendix, Rotoren und Zubehör/Rotors and accessories") sind die Dichtungsringe regelmäßig (wöchentlich) zu prüfen und zu reinigen. Bei Anzeichen von Rissbildung, Versprödung oder Abnutzung ist der Dichtungsring sofort auszutauschen. Um ein Verdrehen des Dichtungsringes während dem Öffnen und Schließen des Deckels zu vermeiden, muss der Dichtungsring mit Talkum-Puder oder einem Gummi-Pflegemittel leicht eingerieben werden.
- Um Korrosion infolge Feuchtigkeit zwischen Rotor und Motorwelle zu verhindern, sollte der Rotor mindestens einmal im Monat ausgebaut, gereinigt und die Motorwelle leicht gefettet werden.
- Die Rotoren und die Zubehörteile sind monatlich auf Verschleiß und Korrosionsschäden zu überprüfen. Bei Ausschwingrotoren muss vor allem der Bereich der Tragzapfen und bei Gehängen die Nuten und der Boden auf Risse geprüft werden.



Rotoren und Zubehör dürfen bei Anzeichen von Verschleiß oder Korrosion nicht mehr verwendet werden.

- Den Rotor wöchentlich auf festen Sitz prüfen.

36.2.2 Desinfektion

- Gelangt infektiöses Material auf die Rotoren oder auf das Zubehör, so muss eine geeignete Desinfektion durchgeführt werden.
- Inhaltsstoffe geeigneter Desinfektionsmittel:
Glutaraldehyd, Propanol, Ethylhexanol, anionische Tenside, Korrosionsinhibitoren.
- Nach dem Einsatz von Desinfektionsmitteln, die Reste des Desinfektionsmittels, durch Nachspülen mit Wasser (nur außerhalb der Zentrifuge) oder Nachwischen mit einem feuchten Tuch, entfernen.
- Die Rotoren und das Zubehör müssen unmittelbar nach der Desinfektion getrocknet werden.

36.2.3 Entfernen radioaktiver Verunreinigungen

- Das Mittel muss speziell für das Entfernen radioaktiver Verunreinigungen ausgewiesen sein.
- Inhaltsstoffe geeigneter Mittel für das Entfernen radioaktiver Verunreinigungen:
Anionische Tenside, nichtionische Tenside, polyhydrierter Äthanol.
- Nach dem Entfernen der radioaktiven Verunreinigungen, die Reste des Mittels, durch Nachspülen mit Wasser (nur außerhalb der Zentrifuge) oder Nachwischen mit einem feuchten Tuch, entfernen.
- Die Rotoren und das Zubehör müssen unmittelbar nach dem Entfernen der radioaktiven Verunreinigungen getrocknet werden.

36.2.4 Tragzapfen

Bei Ausschwingrotoren müssen die Tragzapfen regelmäßig gefettet werden (Hettich-Schmierfett Nr. 4051), um ein gleichmäßiges Ausschwingen der Gehänge zu gewährleisten.

36.2.5 Rotoren und Zubehör mit begrenzter Verwendungsdauer

Die Verwendung von bestimmten Rotoren, Gehängen und Zubehörteilen ist zeitlich begrenzt.

Diese sind mit der maximal erlaubten Anzahl der Lauf-Zyklen oder dem Ablaufdatum und der maximalen Anzahl der Lauf-Zyklen oder nur mit dem Ablaufdatum gekennzeichnet, z.B.:

- "einsetzbar bis Ende: IV. Quartal 2011 / usable until end of: IV. Quartal 2011" oder
"einsetzbar bis Ende Monat/Jahr: 10/2011 / usable until end of month/year: 10/2011"
- "max. Laufzyklen / max. cycles: 40000"



Aus Sicherheitsgründen dürfen die Rotoren, Gehänge und Zubehörteile nicht mehr verwendet werden, wenn entweder die darauf gekennzeichnete maximal erlaubte Anzahl der Lauf-Zyklen oder das darauf gekennzeichnete Ablaufdatum erreicht ist.

Die Anzahl der Zentrifugationsläufe kann abgefragt werden, siehe Kapitel "Abfrage der Betriebsstunden und der Anzahl der Zentrifugationsläufe".

36.3 Autoklavieren

Ausschwingrotoren, Winkelrotoren aus Aluminium, Gehänge aus Metall, Deckel mit Bioabdichtung sowie Gestelle und Reduzierungen können bei 121°C / 250°F (20 min) autoklaviert werden.

Im Zweifelsfall muss beim Hersteller nachgefragt werden.

Über den Sterilitätsgrad kann keine Aussage gemacht werden.



Die Deckel der Rotoren und Behälter müssen vor dem Autoklavieren abgenommen werden.
Das Autoklavieren beschleunigt den Alterungsprozess von Kunststoffen. Außerdem kann es bei Kunststoffen Farbveränderungen verursachen.

Wir empfehlen nach dem Autoklavieren die Dichtungsringe von Bio-Sicherheitssystemen auszutauschen.

36.4 Zentrifugiergefäße

- Bei Undichtigkeit oder nach dem Bruch von Zentrifugiergefäßen, sind zerbrochene Gefäßteile, Glassplitter und ausgelaufenes Zentrifugiergut vollständig zu entfernen.
- Die Gummieinlagen sowie die Kunststoff-Hülsen der Rotoren sind nach einem Glasbruch zu ersetzen.



Verbleibende Glassplitter verursachen weiteren Glasbruch !

- Handelt es sich um infektiöses Material so ist umgehend eine Desinfektion durchzuführen.

37 Störungen

Lässt sich der Fehler laut Störungstabelle nicht beheben, so ist der Kundendienst zu benachrichtigen.

Bitte den Zentrifugentyp und die Seriennummer angeben. Beide Nummern sind auf dem Typenschild der Zentrifuge ersichtlich.



Einen NETZ-RESET durchführen:

- Den Netzschalter ausschalten (Schalterstellung "0").
- Mindestens 10 Sekunden lang warten und anschließend den Netzschalter wieder einschalten (Schalterstellung "I").

Anzeige		Ursache	Beseitigung
keine Anzeige		keine Spannung. Auslösen der Überstromsicheresicherung. Auslösen des Sicherungsautomaten (nur bei Typen 1701-01 und 1706-01).	<ul style="list-style-type: none"> - Versorgungsspannung überprüfen. - Sicherungsautomat wieder einschalten, siehe Kapitel "Sicherungsautomat einschalten" (nur bei Typen 1701-01 und 1706-01). - Netzschalter EIN.
TACHO - ERROR	1, 2, 96	Tacho defekt. Motor, Elektronik defekt.	<ul style="list-style-type: none"> - Deckel öffnen. - Den Netzschalter ausschalten (Schalterstellung "0"). - Mindestens 10 Sekunden lang warten. - Den Rotor von Hand kräftig drehen. - Den Netzschalter wieder einschalten (Schalterstellung "I"). Während des Einschaltens muss sich der Rotor drehen.
IMBALANCE		Der Rotor ist ungleichmäßig beladen.	<ul style="list-style-type: none"> - Deckel öffnen. - Die Beladung des Rotors überprüfen, siehe Kapitel "Beladen des Rotors". - Den Zentrifugationslauf wiederholen.
CONTROL - ERROR	4.1 – 4.5, 6	Fehler Deckelverriegelung	- Einen NETZ-RESET durchführen.
N > MAX	5	Überdrehzahl	
N < MIN	13	Unterdrehzahl	
ROTORCODE	10.1–10.3	Fehler Rotorcodierung	
MAINS INTERRUPT		Netzunterbrechung während des Zentrifugationslaufes. (Der Zentrifugationslauf wurde nicht beendet.)	<ul style="list-style-type: none"> - Deckel öffnen. - Taste drücken. - Bei Bedarf den Zentrifugationslauf wiederholen.
VERSION-ERROR	12	Keine Übereinstimmung der Elektronik-Komponenten Fehler / Defekt Elektronik	- Einen NETZ-RESET durchführen.
CONTROL-ERROR	22, 25.1–25.4	Fehler / Defekt Elektronik	
SER I/O - ERROR	31, 34, 36	Fehler / Defekt Elektronik	
° C * - ERROR	51, 53 – 55, 97, 98	Fehler / Defekt Elektronik	
° C * - ERROR	52	Übertemperatur im Schleuderraum. Fehler / Defekt Elektronik	
FU / CCI - ERROR	60, 61.2-61.20, 61.128 - 61.131, 62	Fehler / Defekt Elektronik / Motor	
FU / CCI - ERROR	61.1	Netzspannung zu niedrig. Fehler / Defekt Elektronik / Motor	<ul style="list-style-type: none"> - Netzspannung überprüfen. - Einen NETZ-RESET durchführen.

Anzeige		Ursache	Beseitigung
SENSOR-ERROR	90	Fehler / Defekt Elektronik	– Einen NETZ-RESET durchführen.
SENSOR-ERROR	91 - 93	Fehler / Defekt Unwuchtsensor	
NO ROTOR OR ROTORCODE ERROR		Kein Rotor eingebaut. Tacho defekt.	– Deckel öffnen. – Rotor einbauen.
WRONG ROTOR !!!		(nur bei Typ 1701-30) Es ist ein Rotor eingebaut, der nicht für den Typ 1701-30 zugelassen ist.	– Deckel öffnen. – Rotor 1798 einbauen.
N > ROTOR MAX		Drehzahl im angewählten Programm größer als die maximale Drehzahl des Rotors.	– Drehzahl überprüfen und korrigieren.
N > ROTOR MAX in Prog : z. B. 3		Auf dem angezeigten Programmplatz befindet sich ein Programm, dessen Drehzahl größer als die maximale Drehzahl des Rotors ist.	
Runtime 00:00 in Prog : z. B. 3		Auf dem angezeigten Programmplatz befindet sich ein Dauerlauf-Programm.	– In der Programmverknüpfung das Dauerlauf-Programm durch ein Programm mit Zeitvorwahl ersetzen.
Empty Program		Auf dem angezeigten Programmplatz ist keine Programmverknüpfung gespeichert.	– Eine Programmverknüpfung abrufen.
FC INIT ERROR		Fehler / Defekt Elektronik	– Einen NETZ-RESET durchführen.
FC VERSION ERROR		Fehler / Defekt Elektronik	
FATAL EEPROM ERROR	1 - 5	Fehler / Defekt Elektronik	

38 Sicherungsautomat einschalten (nur bei Typen 1701-01 und 1706-01)



Den Netzschalter ausschalten und die Zentrifuge vom Netz trennen!

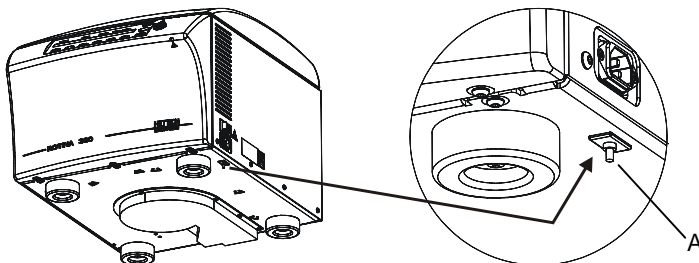

- Den Kunststoffstift (A) des Sicherungsautomaten drücken.
- Die Zentrifuge wieder ans Netz anschließen.

39 Reparaturannahme von Zentrifugen

Wird die Zentrifuge zur Reparatur an den Hersteller zurückgesandt, so muss diese, zum Schutz von Personen, Umwelt und Material, vor dem Versand dekontaminiert und gereinigt werden.

Eine Annahme von kontaminierten Zentrifugen behalten wir uns vor.

Anfallende Kosten für Reinigungs- und Desinfektionsmaßnahmen werden dem Kunden in Rechnung gestellt.

Wir bitten dafür um Ihr Verständnis.

40 Entsorgung

Vor der Entsorgung muss das Gerät, zum Schutz von Personen, Umwelt und Material, dekontaminiert und gereinigt werden.

Bei der Entsorgung des Geräts sind die jeweiligen gesetzlichen Vorschriften zu beachten.

Gemäß der Richtlinie 2002/96/EG (WEEE) dürfen alle nach dem 13.08.2005 gelieferten Geräte nicht mehr mit dem Hausmüll entsorgt werden. Das Gerät gehört zur Gruppe 8 (Medizinische Geräte) und ist in den Business-to-Business-Bereich eingeordnet.



Mit dem Symbol des durchgestrichenen Abfalleimers wird darauf hingewiesen, dass das Gerät nicht mit dem Hausmüll entsorgt werden darf.

Die Entsorgungsvorschriften der einzelnen EU-Länder können unterschiedlich sein. Im Bedarfsfall wenden Sie sich bitte an Ihren Lieferanten.

Contents

1	Use according to specification	33
2	Residual risks	33
3	Technical specifications	33
4	Notes on safety	34
5	Symbol meanings	35
6	Delivery checklist	35
7	Unpacking the centrifuge	36
8	Initial operation	36
9	Interface (only for centrifuge with interface)	36
10	Opening and closing the lid	36
10.1	Opening the lid	36
10.2	Closing the lid	37
11	Installation and removal of the rotor	37
12	Loading the rotor	37
13	Aerosol tight sealing of angle rotors	38
14	Control and display elements	38
14.1	Control knob	38
14.2	Keys and setting options	38
15	Enter centrifugation parameters	39
15.1	Running time	39
15.2	Speed (RPM)	39
15.3	Relative centrifugal force (RCF) and centrifuging radius (RAD)	40
15.3.1	Centrifuging radius (RAD)	40
15.3.2	Relative centrifugal force (RCF)	40
15.4	Run-up and run-down parameters	40
15.4.1	Run-up step	40
15.4.2	Braking step	40
15.4.3	Brake switch-off speed	40
15.5	Temperature (only for centrifuge with refrigeration)	40
16	Programming	40
16.1	Preset programs	41
16.2	Inputting or changing programs	41
16.3	Calling up programs	41
16.4	Write protection for programs	41
16.5	Program linkage	42
16.5.1	Activating or deactivating program linkage	42
16.5.2	Linking programs or changing a program linkage	42
16.5.3	Calling up program linkage	42
16.6	Automatic temporary storage	42
17	Centrifugation	43
17.1	Centrifugation with preselected time	43
17.2	Continuous operation	43
17.3	Short-time centrifugation	44

18	Change the settings during the centrifugation run	44
19	Emergency Stop.....	44
20	Acoustic signal	44
21	Displayed centrifugation data after switch-on.....	44
22	Set temperature unit (only for centrifuge with refrigeration).....	45
23	Setting program locks.....	45
24	PIN (Personal Identification Number)	45
24.1	Setting or changing the PIN	46
24.2	Changing a forgotten PIN	46
25	Centrifuge address.....	46
26	RCF integral and B ramp functions	46
27	Query of operating hours and the number of centrifugation runs	47
28	Querying system information.....	47
29	Immediate display of centrifugation data after switch-on.....	47
30	Cooling (only in centrifuges with cooling)	47
30.1	Standby-cooling	47
30.2	Precooling of the rotor.....	48
31	Heating (only on centrifuges with heating/cooling option)	48
32	Relative centrifugal force (RCF)	48
33	Centrifugation of materials or mixtures of materials with a density higher than 1.2 kg/dm ³	49
34	Rotor Identification	49
35	Emergency release	49
36	Maintenance and servicing.....	50
36.1	Centrifuge (housing, lid and centrifuging chamber).....	50
36.1.1	Surface cleaning and care	50
36.1.2	Surface disinfection	50
36.1.3	Removal of radioactive contaminants	50
36.2	Rotors and Attachments	51
36.2.1	Cleaning and care.....	51
36.2.2	Disinfection	51
36.2.3	Removal of radioactive contaminants	51
36.2.4	Trunnions.....	51
36.2.5	Rotors and accessories with limited service lives	52
36.3	Autoclaving	52
36.4	Centrifuge containers.....	52
37	Faults	53
38	Switch on automatic circuit breaker.....	54
39	Acceptance of the centrifuges for repair.....	54
40	Disposal	54
41	Anhang / Appendix.....	108
41.1	Rotoren und Zubehör / Rotors and accessories.....	108
41.1.1	ROTINA 380 / 380 R, Typen / types 1701, 1701-01, 1706, 1706-01	108
41.1.2	ROTINA 380, Typ / type 1701-30	131

1 Use according to specification

The machine presented here is a medical product (laboratory centrifuge) according to the IVD guideline 98/79/EG. The centrifuge is used to separate substances or substance mixtures with a density of max. 1.2 kg/dm³. This also includes substances and substance mixtures of human origin. The centrifuge is only intended to be used for this purpose. A different use or application over and above this is deemed not in accordance with the specifications. The company Andreas Hettich GmbH & Co. KG undertakes no liability for damages resulting therefrom.

Belonging to the application according to specification is also the observance of all references contained in the Instruction Manual and compliance with the inspection and maintenance works.

2 Residual risks

The machine is constructed according to the state of the art and the recognized technical safety regulations. Improper use and handling can result in dangers to life and limb of the user or third parties and impairments to the machine or to other material assets. The machine is only to be used for the specified applications and only in an impeccable technical safety condition.

Disturbances that can interfere with the safety are to be immediately rectified.

3 Technical specifications

Manufacturer	Andreas Hettich GmbH & Co. KG D-78532 Tuttlingen				
Model	ROTINA 380			ROTINA 380 R	
Type	1701-30	1701	1701-01	1706, 1706-50	1706-01
Mains voltage (± 10%)	200-240 V 1~ / 100-127 V 1~	200-240 V 1~	100-127 V 1~	200-240 V 1~	110-127V 1~
Mains frequency	50 – 60 Hz	50 – 60 Hz	50 – 60 Hz	50 – 60 Hz	60 Hz
Connected load	max. 450 VA	650 VA	700 VA	1300 VA	1400 VA
Current consumption		3.3 A	7.0 A	6.5 A	13.0 A
Cooling medium	----			R 404A	
Max. capacity	4 x 290 ml				
Allowed density	1.2 kg/dm ³				
Speed (RPM)	4000	15000			
Force (RCF)	3095	24400			
Kinetic energy	6200 Nm	18500 Nm		35000 Nm	
Obligatory inspection (BGR 500)	no	yes			
Ambient conditions (EN / IEC 61010-1)	<ul style="list-style-type: none"> – Set-up site – Altitude – Ambient temperature – Humidity – Excess-voltage category (IEC 60364-4-443) – Pollution degree 				
	<p style="text-align: center;">Indoors only</p> <p style="text-align: center;">Up to 2000 m above sea level</p> <p style="text-align: center;">2°C to 35°C 5°C to 35°C</p> <p style="text-align: center;">Maximum relative humidity 80% for temperatures up to 31°C, linearly decreasing to 50% relative humidity at 40°C.</p>				
Device protection class	I				
Not suitable for use in explosion-endangered areas.					
EMC	<ul style="list-style-type: none"> – Emitted interference, Interference immunity 				
	EN / IEC 61326-1, Class B; FCC Class B	EN / IEC 61326-1, Class B	FCC Class B	EN / IEC 61326-1, Class B	FCC Class B
Noise level (dependent on rotor)	≤ 58 dB(A)	≤ 65 dB(A)		≤ 64 dB(A) ¹⁾	
Dimensions	<ul style="list-style-type: none"> – Width – Depth – Height 				
		457 mm		457 mm	
		600 mm		750 mm	
		418 mm		418 mm	
Weight	approx. 58.5 kg	approx. 51 kg	approx. 58.5 kg	approx. 81 kg	approx. 88.5 kg

1) for rotor 1797 ≤ 70 dB(A)

4 Notes on safety



No claim of warranty will be considered by the manufacturer unless ALL instructions in this manual have been followed.



- **The centrifuge should be installed on a good, stable base.**
- **Before using the centrifuge absolutely check the rotor for firm placement.**
- **When the centrifuge is running, according to EN / IEC 61010-2-020, no persons, dangerous substances or objects may be within the safety margin of 300 mm around the centrifuge.**
- **Rotors, suspensions and accessories that possess traces of corrosion or mechanical damage or if their term of use has expired may not be used any longer.**
- **The centrifuge may no longer be put into operation when the centrifuging chamber has safety-related damages.**
- **With swing-out rotors the trunnions must be regularly lubricated (Hettich Lubricating Grease No. 4051) in order to ensure consistent swinging out of the hangers.**

- **Before the initial operation of your centrifuge you should read and pay attention to the operating instructions. Only personnel that has read and understood the operating instructions are allowed to operate the device.**
- Along with the operating instructions and the legal regulations on accident prevention, you should also follow the recognised professional regulations for working in a safe and professional manner. These operating instructions should be read in conjunction with any other instructions concerning accident prevention and environmental protection based on the national regulations of the country where the device is to be used.
- This centrifuge is a state-of-the-art piece of equipment which is extremely safe to operate. However, it can lead to danger for users or others if used by untrained staff, in an inappropriate way or for a purpose other than that it was designed for.
- The centrifuge must not be moved or knocked during operation.
- In case of fault or emergency release, never touch the rotor before it has stopped turning.
- To avoid damage due to condensate, when changing from a cold to a warm room the centrifuge must either heat up for at least 3 hours in the warm room before being connected to the mains, or run hot for 30 minutes in the cold room.
- Only the rotors and accessories approved by the manufacturer for this device may be used (see chapter "Anhang/Appendix, Rotoren und Zubehör/Rotors and accessories").
- The centrifuge rotor may only be loaded in accordance with the chapter "Loading the rotor".
- When centrifuging with maxim revolutions per minute the density of the materials or the material mixtures may not exceed 1.2 kg/dm³.
- The centrifuge may only be operated when the balance is within the bounds of acceptability.
- The centrifuge may not be operated in explosion-endangered areas.
- The centrifuge must not be used with:
 - inflammable or explosive materials
 - materials that react with one another producing a lot of energy.
- If users have to centrifuge hazardous materials or compounds contaminated with toxic, radioactive or pathogenic micro-organisms, they must take appropriate measures.
 For hazardous substances centrifuge containers with special screw caps must strictly be used. In addition to the screw cap centrifuge containers, for materials in hazard category 3 and 4 a biosafety system must be used (see the World Health Organisation's "Laboratory Biosafety Manual").
 In a biosafety system, droplets and aerosols are prevented from escaping by a bioseal (packing ring).
 If the hanger of a biosafety system is used without the lid, the packing ring must be removed from the hanger in order to prevent the packing ring from being damaged during the centrifugation run. Damaged packing rings must not be used to seal the biosafety system.
 Without the use of a biosafety system the centrifuge is not microbiologically sealed in the sense of the EN / IEC 610101-2-020 standard.

For further details of available biosafety systems see chapter "Anhang/Appendix, Rotoren und Zubehör/Rotors and accessories". If in doubt, you should obtain relevant information from the manufacturer.

- The centrifuge must not be operated with highly corrosive substances which could impair the mechanical integrity of rotors, hangers and accessories.
- Repairs must only be carried out by personnel authorised to do so by the manufacturer.
- Only original spare parts and original accessories licensed by the Andreas Hettich GmbH & Co. KG company are allowed to be utilised.
- The following safety regulations apply:
EN / IEC 61010-1 and EN / IEC 61010-2-020 as well as their national deviations.
- The safe operation and reliability of the centrifuge can only be guaranteed if:
 - the centrifuge is operated in accordance with the operating instructions,
 - the electrical installation on the site where the centrifuge is installed conforms to the demands of EN / IEC stipulations,
 - prescribed tests to BGV A1, BGR 500 are carried out by an expert.

5 Symbol meanings



Symbol on the machine:

Attention, general hazard area.

Before using the centrifuge implicitly read the operating instructions and pay attention to the safety relevant references!



Symbol in this document:

Attention, general hazard area.

This symbol refers to safety relevant warnings and indicates possibly dangerous situations.

The non-adherence to these warnings can lead to material damage and injury to personal.



Symbol on the machine and in this document:

Beware of hot surface.

Nonobservance of this warning can lead to material damage and personal injury.



Symbol on the machine and in this document:

Plastic suspension can only be used in temperatures up to a maximum of 40°C / 104°F.

Nonobservance of this warning can lead to material damage and personal injury.



Symbol on the machine:

Equipotential: Connector (PE connector) for potential equalization (only for centrifuge with PE connector).



Symbol on the machine:

RS232 interface (only for centrifuges with RS232 interface).



Symbol on the machine:

Automatic circuit breaker (only for types 1701-01 and 1706-01).



Symbol in this document:

This symbol refers to important circumstances.



Symbol on the machine and in this document:

Symbol for the separate collection of electric and electronic devices according to the guideline 2002/96/EG (WEEE). The device belongs to Group 8 (medical devices).

Applies in the countries of the European Union, as well as in Norway and Switzerland.

6 Delivery checklist

- 1 Connecting cable
- 1 Hex. pin driver 5 mm
- 1 Lubricating grease for trunnions
- 1 Operating instructions
- 1 Notes on moving the equipment safely
- 1 CD (for type 1701-30 only)

The rotor(s) and associated accessories are included in the delivery in the quantity ordered.

7 Unpacking the centrifuge

- Lift the carton upward and remove the padding.



Do not lift by the front panel.

Observe the weight of the centrifuge, refer to chapter "Technical specifications".

Lift the centrifuge on both sides with an appropriate number of helpers and place it on the laboratory table.

8 Initial operation

- According to the laboratory instrument standards EN / IEC 61010-2-020 an emergency switch to separate power supply in the event of a failure must be installed in the building electrical system. This switch has to be placed remote from the centrifuge, preferred outside of the room in which the centrifuge is installed or near by the exit of this room.
- **Position the centrifuge in a stable and level manner in a suitable place. During set-up, the required safety margin of 300 mm around the centrifuge is to be kept according to EN / IEC 61010-2-020.**



When the centrifuge is running, according to EN / IEC 61010-2-020, no persons, dangerous substances or objects may be within the safety margin of 300 mm around the centrifuge.

- Do not place any object in front of the ventiduct.
Keep a ventilation area of 300 mm around the ventiduct.
- Centrifuge with PE connector:
If required, connect the PE connector at the back of the device with an additional medical potential equalization system.
- Centrifuge with RS232 interface:
Connect the RS232 centrifuge interface with an RS232 connecting cable (not included in the scope of delivery) to the PC.
- Check whether the mains voltage tallies with the statement on the type plate.
- Connect the centrifuge with the connection cable to a standard mains socket. For connection ratings refer to Chapter "Technical specifications".
- Switch on the mains switch (switch position "I"). The LEDs in the keys are blinking.
The following displays appear one after the other:
 1. The centrifuge model
 2. The program version
 3. The rotorcode (rotor), the maximum rotor speed (Nmax) and the preset centrifuging radius (R) of the last rotor that was recognized by rotor recognition.
 4. **OPEN / OEFFNEN**
- Open the lid.
The centrifuge data of the last used program or program 1 will be displayed.
- Remove the transport safety device (see instruction sheet on "Moving the equipment safely").

9 Interface (only for centrifuge with interface)

As an option, the device can be equipped with an RS232 interface.

The RS232 interface is labeled with the  symbol.

The centrifuge can be controlled and data queried via this interface.



The LED in the  key lights up during data communication.

10 Opening and closing the lid

10.1 Opening the lid



The lid can only be opened when the centrifuge is switched on and the rotor is at rest. If it cannot be opened under these circumstances, see the section on "Emergency release".

- Press the button . The lid unlocks via the motor and the left LED in the pushbutton  extinguishes.

10.2 Closing the lid



Do not put your fingers between lid and housing.
Do not bang the lid shut.

If the left LED in the **OPEN/STOP** button flashes, press the **OPEN/STOP** button so that the motor-driven lid lock goes into the basic position (opened).

- Place the lid and lightly press down the front edge of the lid. The locking action is effected by motor. The left LED in the button **OPEN/STOP** lights up.

11 Installation and removal of the rotor

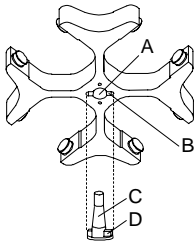

- Clean the motor shaft (C) and the rotor drilling (A), and lightly grease the motor shaft afterwards. Dirt particles between the motor shaft and the rotor hinder a perfect seating of the rotor and cause an irregular operation.
- Place the rotor vertically on the motor shaft. The motor shaft dog (D) has to fit in the rotor slot (B). The alignment of the groove is labelled on the rotor.
- Tighten the rotor tension nut with the supplied wrench by turning in a clockwise direction.
- Check the rotor for firm seating.
- Loosening the rotor: Loosen the tension nut by turning in a counter clockwise direction, and turning until the working point for lifting. After passing the working point for lifting the rotor is loosened from the motor shaft cone. Turn the tension nut until the rotor is able to be lifted from the motor shaft.

12 Loading the rotor



Standard centrifuge containers of glass will not stand RCF values exceeding 4000 (DIN 58970, pg. 2).

- Check the rotor for firm seating.
With swing-out rotors all rotor positions must be lined with **identical** hangers. Certain hangers are marked with the number of the rotor position. These hangers may only be used in the respective rotor position. Hangers that are marked with a set number (e.g. S001/4) may only be used in the set.
- The rotors and hangers may only be loaded symmetrically. The centrifuge containers have to be distributed evenly on all rotor positions. For authorised combinations see Chapter "Anhang/Appendix, Rotoren und Zubehör/Rotors and accessories".
In the case of angle rotors all possible rotor positions must be loaded, see chapter "Anhang/Appendix, Rotoren und Zubehör/Rotors and accessories".

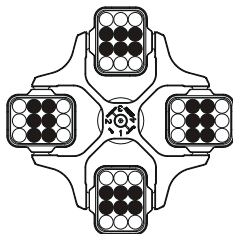

Rotor is evenly loaded

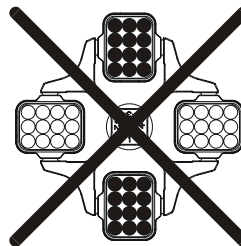

Not permitted!
Rotor is not evenly loaded

- On certain hangers, the weight of the maximum load or the weight of the maximum load and the maximum weight of the completely loaded hanger is specified. This weight may not be exceeded. In case of exception, see chapter "Centrifugation of materials or mixtures of materials with a density higher than 1.2 kg/dm³". The weight specified for the maximum loading includes the total weight of adapter, frame, centrifuging container and content.
- In containers with rubber inserts, the same number of rubber inserts must always be among the centrifuge containers.
- Always fill the centrifuge containers outside of the centrifuge.
- No liquid should be allowed to enter the centrifugal chamber during filling and swinging out of the hangers.
- The maximum filling quantity for the centrifuge containers specified by the manufacturer must not be exceeded.
- In order to maintain the weight differences within the centrifuge container as marginal as possible, a consistent fill level in the containers is to be heeded.

13 Aerosol tight sealing of angle rotors

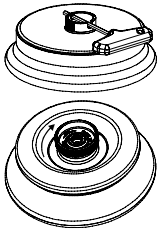

To ensure aerosol sealing the lid of an aerosol sealed angular rotor must be firmly closed.

This is performed with the help of the supplied spanner that is inserted through the borehole in the rotary handle. If the rotary handle does not have a borehole then the lid must be firmly closed by turning in clockwise direction.

For available aerosol tight angle rotors, please see chapter "Anhang/Appendix, Rotoren und Zubehör/Rotors and accessories".

14 Control and display elements

See figure on page 2.

Fig. 2, Fig. 3: Display and control panel

14.1 Control knob



For setting the individual parameters.

Turning anticlockwise reduces the value. Turning clockwise increases the value.

14.2 Keys and setting options



- Running time, parameters **t/hms**.

h: hours. Adjustable from 1 h to 99 h, in 1 hour increments.

m: minutes. Adjustable from 1 min to 59 min, in 1 minute increments.

s: seconds. Adjustable from 1 s to 59 s, in 1 second increments.

- Continual running " ∞ "



- Revolution, parameters **rpm**.

Adjustable from 50 rpm to a maximum rotor speed of the rotor (N_{max}), in increments of 10. For maximum rotor speed, see chapter "Anhang/Appendix, Rotoren und Zubehör/Rotors and accessories".



- Relative centrifugal force, parameter **RCF**.

The RCF is shown in brackets $\langle \rangle$. The LED in the button lights up.

The figure that is adjustable is the figure that produces a revolution speed between 50 rpm and the maximum rotor speed (N_{max}). Adjustable in increments of 1.

- Centrifuging radius, parameters **RAD**.

Adjustable from 85 mm to 330 mm in 1 millimeter increments. For centrifuging radius, see chapter "Anhang/Appendix, Rotoren und Zubehör/Rotors and accessories".



Run-in and run-out parameters

- Run-in steps, parameters .

Step 9 = shortest run-in time, ... Step 1 = longest run-in time.

- Braking step, parameters .

Step 9 = shortest run-out time, ... Step 1 = long run-out time, step 0 = non-braked run-out.

- Brake switch-off revolution, parameters **N Brake**.

Adjustable from 50 rpm to the maximal rotor speed (N_{max}) in increments of 10.

Once the rotor speed has been reached, non-braked run-out begins.



- Temperature (only for centrifuge with refrigeration)

Adjustable in degrees Celsius ($^{\circ}\text{C}$) or in degrees Fahrenheit ($^{\circ}\text{F}$). For setting the temperature unit, see chapter "Temperatur-Einheit einstellen/Setting the temperature unit".





Parameters **T/ $^{\circ}\text{C}$** = degrees Celsius ($^{\circ}\text{C}$).

Adjustable from -20°C to $+40^{\circ}\text{C}$, in 1°C increments (for the heat/cool option, adjustable in the range from -20°C to $+90^{\circ}\text{C}$).

Parameters **T/ $^{\circ}\text{F}$** = degrees Fahrenheit ($^{\circ}\text{F}$).

Adjustable from 4°F to $+104^{\circ}\text{F}$, in 1°F increments (for the heat/cool option, adjustable in the range from -4°F to $+194^{\circ}\text{F}$).

The lowest temperature that can be reached depends on the rotor (see chapter "Anhang/Appendix, Rotoren und Zubehör/Rotors and accessories").

- 
 - Call up programs and program linkages; parameter **RCL**.
Programs: Program locations 1 to 99 and PREC. program linkages: Program locations A to Z.
 - Save programs and program linkages; parameter **STO**.
99 programs can be saved (for centrifuges without refrigeration: program places 1 to 99, for centrifuges with refrigeration: program places 1 98 and PREC). The program place PREC (PRECOOLING) is reserved for the precooling program. Program place 0 is used for temporary storage for centrifuge data from the last centrifugation run. No programs can be saved at this program place.
It is possible to save 25 program linkages (program locations A to Z; there is no program location J). A program linkage can consist of 20 programs.
 - Link programs; parameter **EDIT**.
 - Start "Machine Menu" (keep the key held down for 8 seconds) and select the parameters from this menu.
- 
 - Start rotor precooling (only for centrifuges with refrigeration). The LED in the key is lit during the centrifugation run, as long as the rotor is revolving.
Precooling of the rotor takes place automatically with the **PREC** (PRECOOLING) program.
- 
 - Start centrifugation run. The LED in the key is lit during the centrifugation run, as long as the rotor is revolving.
 - Short-time centrifugation.
The centrifugation run occurs while the key is kept pressed. The LED in the key is lit during the centrifugation run, as long as the rotor is revolving.
 - Saving entries and changes.
- 
 - End centrifugation run.
The rotor decelerates with the preset run-down parameters. The right-hand LED in the button lights up until the rotor is stationary. Once the rotor is stationary the left-hand LED flashes in the button. Pressing the button twice triggers the EMERGENCY STOP.
 - Unlock the lid.
The left-hand LED in the button goes out.
 - Leave parameter input and the "Machine Menu".

15 Enter centrifugation parameters

 If no key is pressed for 8 seconds long after the selection or during the input of parameters, the previous values will be shown in the display. The input of parameter then has to be executed again.





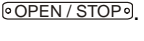

When you enter several parameters, the  key does not have to be pressed until you have made the settings for the last parameter.

If parameters are changed, the program place number is displayed in parentheses (). This means that the centrifugation data in the display no longer corresponds to the centrifugation data from the program place that has been saved.



You can no discontinue entering parameters at any time by pressing the key . In this case the adjustments are not saved.

15.1 Running time

 In order to set continual running, the minutes, seconds and hours have to be set to zero. Continual running is represented in the display by the following symbol, "∞".



- Press the  key. The parameters **t/hms** is displayed. The minutes (**m**) are shown in parentheses < >, and can be changed.
- Use the adjusting knob  to set the value you want.
- Press the  key. The seconds (**s**) are shown in parentheses < > and can be changed.
- Use the adjusting knob  to set the value you want.
- Press the  key. The hours (**h**) are shown in parentheses < > and can be changed.
- Use the adjusting knob  to set the value you want.
- Press the  key, to have the settings applied to the display.

15.2 Speed (RPM)

- Press the  key. The parameters **RPM** is displayed.
- Use the adjusting knob  to set the value you want.
- Press the  key, to have the settings applied to the display.

15.3 Relative centrifugal force (RCF) and centrifuging radius (RAD)



15.3.1 Centrifuging radius (RAD)

- Keep pressing the  key until the parameters **RAD** and **RCF** are displayed, e.g. **RAD = 146** -> **RCF = 3695**. The LED is lit in the key.
- Use the adjusting knob  to set the centrifuging radius you want. By changing the centrifuging radius, the value adjusts automatically to the RCF.
- Press the  key, to have the settings applied to the display.

15.3.2 Relative centrifugal force (RCF)







The relative centrifugal force (RCF) depends on the radius of the centrifuge. Before setting the RCF, the radius of the centrifuge must be set. See chapter "Centrifuge radius (RAD)".





- Keep pressing the  key until the parameters **RCF** and **RAD** are displayed, e.g. **RCF = 3695** **RAD = 146**. The LED is lit in the key.
- Use the adjusting knob  to set the RCF you want.
- Press the  key, to have the settings applied to the display.

15.4 Run-up and run-down parameters



15.4.1 Run-up step

- Press the  key as often as necessary until the parameter  is shown.
- Use the adjusting knob  to set the level you want.
- Press the  key, to have the settings applied to the display.

15.4.2 Braking step

- Press the  key as often as necessary until the parameter  is shown.
- Use the adjusting knob  to set the level you want.
- Press the  key, to have the settings applied to the display.



15.4.3 Brake switch-off speed

- Press the  key as often as necessary until the parameter **N Brake** is shown.
- Use the adjusting knob  to set the value you want.
- Press the  key, to have the settings applied to the display.

15.5 Temperature (only for centrifuge with refrigeration)



The temperature can be entered in degrees Celsius (°C) or in degrees Fahrenheit (°F). For setting the temperature unit, see chapter "Set temperature unit".

- Press the  key. The following parameters are displayed: **T/°C** or **T/°F**.
- Use the adjusting knob  to set the value you want.
- Press the  key, to have the settings applied to the display.









16 Programming



If parameters are changed, the program place number is displayed in parentheses (). This means that the centrifugation data in the display no longer corresponds to the centrifugation data from the program place that has been saved.

16.1 Preset programs (for type 1701-30 only)

 Programs 1 to 4 are preset and write-protected.
 If an attempt is made to save program locations 1 to 4, "**Protected !!**" will be displayed and the data will not be saved.
 When calling up programs, a "+" will be shown by program locations 1 to 4 to indicate that this data is write-protected.
 If the write protection is removed, the data in program locations 1 to 4 can be modified and saved. This storage will only be temporary, however, and the modified data will be lost when the device is switched off.

PROG 1	PROG 2	PROG 3	PROG 4
RAD 155	RAD 155	RAD 155	RAD 155
RCF 200	RCF 800	RCF 600	RCF 600
RPM 1074	RPM 2149	RPM 1861	RPM 1861
Running time 2:15	Running time 10:15	Running time 10:15	Running time 5:15
 9	 9	 9	 9
 0	 6	 6	 6

16.2 Inputting or changing programs

- Set the parameters you want (see chapter "Enter centrifugation parameters").
- Press the **PROG** key as often as necessary until the **STO** parameter is shown.
- Use the adjusting knob \odot to set the program place you want.

 If a "+" is shown after the program location, then this data is write-protected. In this case, the write protection has to be removed first before saving (see the chapter on "Write protection for programs").

- Press the **START** key to have the settings saved to the program place you want. Briefly, **Program store ...** is displayed as confirmation.

 The previous program location data will be overwritten when the new data is saved.
 If "**Protected !!**" is displayed, then the data at the program location is write-protected and it will not be saved.

16.3 Calling up programs

- Press the **PROG** key. The parameters **RCL** is displayed.
- Use the adjusting knob \odot to set the program place you want.

 If a "+" is shown after the program location, then this data is write-protected.

- Press the **START** key. Briefly, **Program recall ...** is displayed as confirmation. The centrifugation data of the selected program place is shown.

16.4 Write protection for programs

The programs can be protected against unintentional modification.

The write protection can be activated/deactivated as follows when the rotor is at a standstill:

- Call up the desired program (see the chapter on "Calling up programs").
- Press the **PROG** key. The parameters **RCL** is displayed.
- Press and hold the **PROG** button for eight seconds.
 After eight seconds, **Set Protection = 1-** (for example) appears in the display.
- Set \odot "+" or "-" with the adjusting knob.
 + = program is write-protected,
 - = program is not write-protected.
- Press the **START** button to save the setting.

16.5 Program linkage

"Program linkage" can be used to link several centrifuge operations together.



A program linkage is only possible if this has been activated (parameter **Multi programs = on**; see the chapter on "Activating or deactivating program linkage").

16.5.1 Activating or deactivating program linkage

The program link can be activated/deactivated as follows when the rotor is at a standstill:

- Press and hold the **PROG** button for eight seconds.
After eight seconds, ***** Machine Menu ***** appears in the display.
- Press the **PROG** key as often as necessary until the **->Settings** is displayed.
- Press the **START** key. The **SOUND / BELL = off/on** is displayed.
- Press the **PROG** key as often as necessary until the **Multi programs = off/on** is displayed.
- Set **off** or **on** with the adjusting knob **○**.
off = program linkage deactivated,
on = program linkage activated.
- Press the **START** key to save the setting.
Briefly, **Store Settings ...** is displayed as confirmation, followed by **-> Settings**.
- Press the **OPEN/STOP** key once to leave the "Settings" menu or press the **OPEN/STOP** key twice to leave the "Machine Menu".

16.5.2 Linking programs or changing a program linkage



It is possible to save 25 program linkages (program locations A to Z; there is no program location J). A program linkage can consist of no more than 20 programs.

The speed adjustment from one program to the next one is always done in a program linkage with the start-up parameter of the next program.

There cannot be any continuous operation programs in a program linkage.

No centrifuge parameters may be modified in a program linkage. A parameter modification is only possible in the individual programs.

The **TIME** button can be used during the centrifuge operation to call up the total run time of the program linkage

(e. g. **Σ=00:05:30**) and the run time of the currently running program (e.g. **t B.02=00:01:00**).

1. Press the **PROG** button repeatedly until the parameter **EDIT A...Z** is displayed.
2. Use the **○** adjusting knob to set the desired program location where the program linkage is to be saved.
3. Press the **START** button. The program location of the program linkage and the first program of the program linkage will be shown (e.g. **EDIT B.01 = 01**).
4. Use the **○** adjusting knob to set the first program of the program linkage.
5. Press the **PROG** button. The next program of the program linkage will be shown (e.g. **EDIT B.02 = END**).
6. Use the **○** adjusting knob to set the next program of the program linkage.
7. Press the **PROG** button. The next program of the program linkage will be shown (e.g. **EDIT B.03 = END**).
8. Repeat steps 6 and 7 until all programs have been set.
9. Set **○ END** with the adjusting knob (turn adjusting knob anti-clockwise).



For program linkages which consist of 20 programs, **END** cannot be set after the 20th program.

10. Press the **START** button. **STO B**, for example, is displayed.
11. Press the **START** button to save the program linkage.
As confirmation, **Multi program store ..** will be shown briefly.

16.5.3 Calling up program linkage

- Press the **PROG** button repeatedly until the parameter **RCL A...Z** is displayed.
- Use the adjusting knob **○** to set the program place you want.
Press the **START** key. Briefly, **Multi program recall ...** is displayed as confirmation.
- The centrifugation data of the first program of the program linkage will be shown.

16.6 Automatic temporary storage

The program place 0 serves as temporary storage for centrifugation data of the last centrifugation run that took place.

No programs can be saved at this program place.

After every start to a centrifugation run, the centrifugation data that is used for the run is automatically saved at program place "0" and can be accessed there.

17 Centrifugation



When the centrifuge is running, according to EN / IEC 61010-2-020, no persons, dangerous substances or objects may be within the safety margin of 300 mm around the centrifuge.



If the permissible weight difference within the rotor loading has been exceeded, the drive shuts down during the start-up, and **IMBALANCE** is displayed.

If the speed in the selected program is higher than the maximum speed of the rotor (Nmax), it will not be possible to start a centrifugation run. The message **N > ROTOR MAX** will be displayed (see Chapter "Faults").

If **N > ROTOR MAX in Prog** : e.g. **5**, **Runtime 00:00 in Prog** : e.g. **5** or **Empty Program** is shown during program linkage, no centrifuge operation can be started (see the chapter on "Faults").

A centrifugation run can be stopped at any time by pushing the key **OPEN/STOP**.

All parameters can be selected and altered during the centrifugation run (see Chapter "Enter centrifugation parameters").

It is possible to switch over between RPM and RCF display at any time using the **RPM** and **RCF** keys. Switching is not possible if program linkages are being used. When working with the RCF display, it is necessary to enter the centrifuging radius.

If **OPEN** **OEFFNEN** is displayed, a further operation of the centrifuge is only possible after opening the lid once.

If the rotor has been changed, no centrifugation run takes place and this display is shown, e.g. **Rotor 4 Nmax= 4500 R=184 mm** (see chapter "Rotor Identification").

Operation errors and malfunctions will be shown (see Chapter "Faults").

- Switch on the mains supply switch. Switch position I.
- Load the rotor and close the centrifuge lid.

17.1 Centrifugation with preselected time

- Set a run time, call up a program with preset time or a program linkage (see the chapters on "Enter centrifugation parameters", "Calling up programs" or "Program linkage").
- Press the **START** key. The LED in the **START** key blinks until the rotor has been imported, it is subsequently lit.
- Once the time has run up or if the centrifugation run is canceled by pressing the **OPEN/STOP** key, run-down takes place with the selected run-down parameter. The run-down parameter is displayed e.g. **9**. The right-hand LED in the **OPEN/STOP** key is lit. Once the rotor has come to a standstill, the LED in the **START** key and the right LED in the **OPEN/STOP** key switch off and the left LED in the **OPEN/STOP** key lights up.

During the centrifugation run, the speed of the rotor or the RCF value resulting from this, the sample temperature (for centrifuges with cooling only) and the remaining time will be displayed.

17.2 Continuous operation

- Set the minutes, seconds and hours to "0" or start a continual run program (see chapter "Enter centrifugation parameter" or "Calling up programs").
- Press the **START** key. The LED in the **START** key blinks until the rotor has been imported, it is subsequently lit. The time count starts from 00:00.
- Press the **OPEN/STOP** key to end the centrifugation run. Run-down is carried out with the selected run-down parameters. The run-down parameter is displayed e.g. **9**. The right-hand LED in the **OPEN/STOP** key is lit. Once the rotor has come to a standstill, the LED in the **START** key and the right LED in the **OPEN/STOP** key switch off and the left LED in the **OPEN/STOP** key lights up.

During the centrifugation run, the speed of the rotor or the RCF value resulting from this, the sample temperature (for centrifuges with cooling only) and the time run will be displayed.

17.3 Short-time centrifugation

 A short-time centrifugation is not possible if program linkages are being used.

- Keep the **[START]** key pressed. The LED in the **[START]** key blinks until the rotor has been imported, it is subsequently lit. The time count starts from 00:00.
- Release the **[START]** key again to end the centrifugation run. Run-down is carried out with the selected run-down parameters. The run-down parameter is displayed e.g. $\sqrt{9}$. The right-hand LED in the **[OPEN/STOP]** key is lit. Once the rotor has come to a standstill, the LED in the **[START]** key and the right LED in the **[OPEN/STOP]** key switch off and the left LED in the **[OPEN/STOP]** key lights up.

During the centrifugation run, the speed of the rotor or the RCF value resulting from this, the sample temperature (for centrifuges with cooling only) and the time run will be displayed.

18 Change the settings during the centrifugation run

 It is not possible to modify settings during centrifuge operation if program linkages are being used.

The running time, the speed, the relative centrifugal force (RCF), the centrifuging radius, the run-up and run-down parameters as well as the temperature (for centrifuges with cooling only) can be changed while the centrifuge is running.

- Select the parameter you want and use the \odot adjusting knob to change the value (see chapter "Enter centrifugation parameter").
- Press the **[START]** key. The changed setting is saved at program place "0" (see chapter "Automatic temporary storage"). The program place number is displayed in parentheses (0). The original program is not overwritten.

19 Emergency Stop

- Press the **[OPEN/STOP]** key twice.

During a not-stop, run-out is carried out with braking level 9 (shortest run-out). Braking level $\sqrt{9}$ is displayed. If braking level 0 has been preselected, run-out is carried out with braking level $\sqrt{9d}$. With braking level 9d, the run-out time is longer, technically speaking, than braking level 9.

20 Acoustic signal

The acoustic signal sounds:

- Upon the appearance of a disturbance in 2 second intervals.
- After completion of a centrifugation run and rotor standstill in 30 second intervals.

The acoustic signal is stopped by opening the lid or pressing any key.

The signal after completion of the centrifugation run can be activated or deactivated in the following manner, if the rotor is at standstill:

- Keep the **[PROG]** key held down for 8 seconds.
After 8 seconds, ***** Machine Menu ***** appears in the display.
- Press the **[PROG]** key as often as necessary until the **->Settings** is displayed.
- Press the **[START]** key. The **SOUND / BELL = off/on** is displayed.
- Use the adjusting knob \odot to set **off** or **on**.
- Press the **[START]** key to save the setting.
Briefly, **Store Settings ...** is displayed as confirmation, followed by **-> Settings**.
- Press the **[OPEN/STOP]** key once to leave the "Settings" menu or press the **[OPEN/STOP]** key twice to leave the "Machine Menu".

21 Displayed centrifugation data after switch-on.

After switch-on the centrifugation data from program 1, or from the last program that was used, is displayed.

If the rotor is at standstill, this can be set as follows:

- Keep the **[PROG]** key held down for 8 seconds.
After 8 seconds, ***** Machine Menu ***** appears in the display.
- Press the **[PROG]** key as often as necessary until the **->Settings** is displayed.
- Press the **[START]** key. The **SOUND / BELL = off/on** is displayed.
- Press the **[PROG]** key as often as necessary until **Start program = Last/First** is displayed.
- Use the adjusting knob \odot to set **Last** or **First**.
Last = the program used last, First = program 1.
- Press the **[START]** key to save the setting.
Briefly, **Store Settings ...** is displayed as confirmation, followed by **-> Settings**.
- Press the **[OPEN/STOP]** key once to leave the "Settings" menu or press the **[OPEN/STOP]** key twice to leave the "Machine Menu".

22 Set temperature unit (only for centrifuge with refrigeration)

The temperature can be entered in degrees Celsius (°C) or in degrees Fahrenheit (°F).

When the rotor is at standstill, the temperature unit must be set as follows:

- Keep the **PROG** key held down for 8 seconds.
After 8 seconds, ***** Machine Menu ***** appears in the display.
- Press the **PROG** key as often as necessary until the **->Settings** is displayed.
- Press the **START** key. The **SOUND / BELL = off/on** is displayed.
- Press the **PROG** key as often as necessary until **Temp Unit = Celsius/Fahrenheit** is displayed.
- Use the adjusting knob \odot to set **Celsius** or **Fahrenheit**.
- Press the **START** key to save the setting.
Briefly, **Store Settings ...** is displayed as confirmation, followed by **-> Settings**.
- Press the **OPEN/STOP** key once to leave the "Settings" menu or press the **OPEN/STOP** key twice to leave the "Machine Menu".

23 Setting program locks

When the rotor is at a standstill, the following program locks can be set:

- LOCK 1** **LOCK 1** is displayed in the " \sim " field.
Programs can only be called up but not modified.
- LOCK 2** **LOCK 2** is displayed in the " \sim " field.
No programs can be called up and modified.
The centrifuge can be controlled via the interface (only for centrifuge with interface).
- LOCK 3** No status display.
No program locking. Programs can be called up and modified.

- Keep the **PROG** key held down for 8 seconds.
After 8 seconds, ***** Machine Menu ***** appears in the display.
- Press the **PROG** key as often as necessary until the **->Change LOCK** is displayed.
- Press the **START** key. The lock status is displayed.
If no PIN has been entered, **LOCK = {3} confirm by START**, for example, will be displayed.
If a PIN has been entered, **LOCK = 3**, for example, will be displayed.
- Use the \odot adjusting knob to set the desired lock status.



If a PIN has been entered, **PIN = ---- confirm by START** will be shown. In this case, a valid PIN has to be entered with the \odot adjusting knob and then the **START** button has to be pressed before the lock status can be set.

- Press the **START** key to save the setting.
Briefly, **Store LOCK 2 ...** is displayed as confirmation, followed by **-> Change LOCK**.
- Press the **OPEN/STOP** key once to leave the "Change LOCK" menu or press the **OPEN/STOP** key twice to leave the "Machine Menu".

24 PIN (Personal Identification Number)

To prevent the program lock from being changed by unauthorized persons, a PIN can be set.



No PIN is set in the factory.

24.1 Setting or changing the PIN

The PIN can be set as follows when the rotor is at a standstill:

- Keep the **[PROG]** key held down for 8 seconds.
After 8 seconds, ***** Machine Menu ***** appears in the display.
- Press the **[PROG]** key as often as necessary until the **->Change PIN** is displayed.
- Press the **[START]** key. **old PIN = ---- <START>** is displayed.
- With the **○** adjusting knob, set the valid PIN.



If the PIN is being set for the first time, then skip this step or set "0000".

Input assistance:

Press and hold the respective button.

[] : Only the 1000s place of the PIN will be changed.

[RCF] : Only the 100s place of the PIN will be changed.

[RPM] : Only the 10s place of the PIN will be changed.

[TIME] : Only the 1s place of the PIN will be changed.

- Press the **[START]** key. **new PIN = ---- <START>** is displayed.



If an incorrect PIN is set, then **old PIN = ---- <START>** will be displayed again. In this case, set the valid PIN with the **○** adjusting knob and then press the **[START]** button.

- With the **○** adjusting knob, set the new PIN.



To delete the PIN, "0000" must be set.

- Press the **[START]** key to save the setting.
Briefly, **Store PIN ...** is displayed as confirmation, followed by **-> Change PIN**.
- Press the **[OPEN/STOP]** key once to leave the "Change PIN" menu or press the **[OPEN/STOP]** key twice to leave the "Machine Menu".

24.2 Changing a forgotten PIN

If the PIN is forgotten, a so-called help number can be called up. With the help of this number, the manufacturer can calculate a PIN which can be used to change the forgotten PIN. In case this is required, please contact your supplier.

- Keep the **[PROG]** key held down for 8 seconds.
After 8 seconds, ***** Machine Menu ***** appears in the display.
- Press the **[PROG]** key as often as necessary until the **->Change PIN** is displayed.
- Press the **[START]** key. **old PIN = ---- <START>** is displayed.
- Press the **[PROG]** key. **Get HELP # no** is displayed.
- Set **yes** with the **○** adjusting knob.
- Press the **[START]** key. **Are you sure ? no** is displayed
- Set **yes** with the **○** adjusting knob.
- Press the **[START]** key. A help number is displayed, e.g. **HELP # = 5487**.
- Note this help number and use it to request the needed PIN.
- Set a new PIN with the PIN you receive (see the chapter on "Setting or changing the PIN").

25 Centrifuge address



Ex works, the address is] = 29. Address is set.

26 RCF integral and B ramp functions



These functions are not activated as standard.

27 Query of operating hours and the number of centrifugation runs

The operating hours are divided up into internal and external operating hours.

Internal operating hours: Total time the device was switched on.

External operating hours: Total time of previous centrifugation runs.

The operating hours and the number of centrifugation runs can be queried as follows when the rotor is at standstill:

- Keep the **PROG** key held down for 8 seconds.
After 8 seconds, ***** Machine Menu ***** appears in the display.
- Press the **PROG** key as often as necessary until the **-> Operating Time** is displayed.
- Press the **START** key. The external operating hours are displayed, e.g. **OP Time ext = 0h25m**.
- Press the **PROG** key. The internal operating hours are displayed, e.g. **OP Time int = 1h36m**.
- Press the **PROG** key. The number of centrifugation runs is displayed, e.g. **Number of Starts = 10**.
- Press the **OPEN/STOP** key twice to leave the menu, "Operating Time" or press the key **OPEN/STOP** three times to leave the "Machine Menu".

28 Querying system information

Rotor information and the program version of the centrifuge as well as the frequency converter can be queried as follows when the rotor is at a standstill:

- Keep the **PROG** key held down for 8 seconds.
After 8 seconds, ***** Machine Menu ***** appears in the display.
- Press the **PROG** key as often as necessary until the **->Info** is displayed.
- Press the **START** key. The rotorcode (rotor), the maximum rotor speed (Nmax) and the preset centrifuging radius (R) of the last rotor that was recognized by the rotor recognition, e.g. **Rotor 4*: Nmax = 4500 R=184**.
The last recognized rotor is marked with a star (*). Use the adjusting knob \odot to have the information of the rotors permitted in the centrifuge displayed.
- Press the **PROG** key. The program version of the centrifuge is displayed, e.g. **SW version = 01.00**.
- Press the **PROG** key. The program version of the frequency converter is displayed e.g. **FC-SW-Version = 4**.
- Press the **OPEN/STOP** key twice to leave the "Info" menu or press the key **OPEN/STOP** three times to leave the "Machine Menu".

29 Immediate display of centrifugation data after switch-on.

- Switch on the power supply. (Switch setting I).
- The first time the display changes optically, (inverse display) press any key and keep it held down. The centrifugation data is displayed immediately.

30 Cooling (only in centrifuges with cooling)

The temperature set-point can be adjusted from -20°C to +40°C / -4°F to +104°F. On centrifuges with a heating/cooling option, the temperature set-point is settable from -20°C to +90°C / -4°F to +194°F. The lowest obtainable temperature is dependent on the rotor (see Chapter "Anhang/Appendix, Rotoren und Zubehör/Rotors and accessories").

30.1 Standby-cooling

When the rotor is at a standstill and when the lid is closed, the centrifugal chamber is cooled down to the preselected temperature if this is lower than 20°C / 68°F.

During the standby cooling, the preset temperature is displayed.

30.2 Precooling of the rotor



For quick precooling of the unloaded rotor and the accessories, it is a good idea to do a centrifugation run with the continuous operation setting and a speed of about 20% of the maximum rotor speed.

The precooling is done automatically with the **PREC** (PRECOOLING) program.

Precooling is not possible if program linkages are being used.

- Press the key. The LED in the key blinks until the rotor has been imported, it is subsequently lit. The time count starts from 00:00.
- Press the key to end the centrifugation run. Run-down is carried out with the selected run-down parameters. The run-down parameter is displayed e.g. 9. The right-hand LED in the key is lit. Once the rotor has come to a standstill, the LED in the key switches off and **OPEN** / **ÖFFNEN** is displayed. The right-hand LED in the key also switches off, the left LED in the key starts blinking and continues blinking until the lid is opened.

During the centrifugation run, the speed of the rotor, or the resulting RCF value, the sample temperature and the remaining time or expired time are displayed.

31 Heating (only on centrifuges with heating/cooling option)

During operation of the centrifuge the centrifuge chamber can be heated as required to the preselected temperature. The heating is switched off when the rotor is stationary.



Risk of burning! The surface temperature of the heating element in the centrifugal chamber of the centrifuge can reach 500°C / 932°F. Do not touch the heating element.



Plastic suspension can only be used in temperatures up to a maximum of 40°C / 104°F.

32 Relative centrifugal force (RCF)

The relative centrifugal force (RCF) is given as a multiple of the acceleration of gravity (g). It is a unit-free value and serves to compare the separation and sedimentation performance.

These values are calculated using the formula below:

$$\text{RCF} = \left(\frac{\text{RPM}}{1000} \right)^2 \times r \times 1,118 \quad \Rightarrow \quad \text{RPM} = \sqrt{\frac{\text{RCF}}{r \times 1,118}} \times 1000$$

RCF = relative centrifugal force

RPM = rotational speed (revolutions per minute)

r = centrifugal radius in mm = distance from the centre of the turning axis to the bottom of the centrifuge.

For more on the centrifugal radius see the chapter "Anhang/Appendix, Rotoren und Zubehör/Rotors and accessories".



The relative centrifugal force (RCF) stands in relation to the revolutions per minute and the centrifugal radius.

33 Centrifugation of materials or mixtures of materials with a density higher than 1.2 kg/dm³

When centrifuging with maximum revolutions per minute the density of the materials or the material mixtures may not exceed 1.2 kg/dm³.

The speed must be reduced for materials or mixtures of materials with a higher density.

The permissible speed can be calculated using the following formula:

$$\text{Reduced speed } (n_{\text{red}}) = \sqrt{\frac{1.2}{\text{Greater density [kg/dm}^3]}} \times \text{maximum speed [RPM]}$$

e.g.: maximum speed RPM 4000, density 1.6 kg/dm³

$$n_{\text{red}} = \sqrt{\frac{1.2 \text{ kg/dm}^3}{1.6 \text{ kg/dm}^3}} \times 4000 \text{ RPM} = 3464 \text{ RPM}$$

In the exceptional case that the maximum loading indicated on the hanger is exceeded, the speed must also be reduced.

The permissible speed can be calculated using the following formula:

$$\text{Reduced speed } (n_{\text{red}}) = \sqrt{\frac{\text{maximum load [g]}}{\text{actual load [g]}}} \times \text{maximum speed [RPM]}$$

e.g.: maximum speed RPM 4000, maximum load 300 g, actual load 350 g

$$n_{\text{red}} = \sqrt{\frac{300 \text{ g}}{350 \text{ g}}} \times 4000 \text{ RPM} = 3703 \text{ RPM}$$

If in doubt you should obtain clarification from the manufacturer.

34 Rotor Identification

After every start of a centrifugation run the rotor utilised is identified.

After changing a rotor, the engine switches off and the rotorcode (rotor), the maximum rotor speed of the rotor (Nmax) and the preset centrifuging radius (R) of the rotor being used are displayed, e.g. **rotor 4 Nmax= 4500 R=184 mm**.

- Press the **OPEN/STOP** key to open the lid, or press the **START** key to start the centrifugation run. For centrifuges with refrigeration, precooling of the rotor can also be started by pressing the **PRECOOL** key.



If, following a rotor change, the maximum speed of the rotor is less than the set speed, the speed is limited to the maximum speed of the rotor. In this case, the program place number is displayed in parentheses ().

35 Emergency release

During a power failure the lid cannot be unlocked by motor. An emergency release has to be executed by hand.



For emergency release disconnect the centrifuge from the mains.
Open the lid only during rotor standstill.

See figure on page 2.

- Switch off the mains switch (switch position "0").
- Look through the window in the lid to be sure that the rotor has come to a standstill.
- Insert the hexagonal wrench key into the bore hole (Fig. 1, A) and carefully rotate by half a turn in clockwise direction until the lid can be opened.
- Pull the hexagon socket head wrench out of the drilling again.
- If the left LED in the **OPEN/STOP** button flashes after the centrifuge is switched on again, press the **OPEN/STOP** button so that the motor-driven lid lock goes into the basic position (opened) again.

36 Maintenance and servicing



Pull the mains plug before cleaning.

Before any other cleaning or decontamination process other than that recommended by the manufacturer is applied, the user has to check with the manufacturer that the planned process does not damage the device.

- Centrifuges, rotors and accessories must not be cleaned in rinsing machines.
- They may only be cleaned by hand and disinfected with liquids.
- The water temperature must be between 20 – 25°C.
- Only detergents/disinfectants may be used which:
 - have a pH between 5 - 8
 - do not contain caustic alkalis, peroxides, chlorine compounds, acids and alkaline solutions
- In order to prevent appearances of corrosion through cleaning agents or disinfectants, the application guide from the manufacturer of the cleaning agent or disinfectant are absolutely to be heeded.

36.1 Centrifuge (housing, lid and centrifuging chamber)

36.1.1 Surface cleaning and care

- Clean the centrifuge housing and the centrifuging chamber regularly, using soap or a mild detergent and a damp cloth if required. For one thing, this services purposes of hygiene, and it also prevents corrosion through adhering impurities.
- Ingredients of suitable detergents: soap, anionic tensides, non-ionic tensides.
- After using detergents, remove the detergent residue by wiping with a damp cloth.
- The surfaces must be dried immediately after cleaning.
- In the event of condensation water formation, dry the centrifugal chamber by wiping out with an absorbent cloth.
- Lightly rub the rubber seal of the centrifuge chamber with talcum powder or a rubber care product after each cleaning.
- The centrifuging chamber is to be checked for damage once a year.



If damage is found which is relevant to safety, the centrifuge may no longer be put into operation. In this case, notify Customer Service.

36.1.2 Surface disinfection

- If infectious materials penetrates into the centrifugal chamber this is to be disinfected immediately.
- Ingredients of suitable disinfectants: ethanol, n-propanol, isopropyl alcohol, glutardialdehyde, quaternary ammonium compounds.
- After using disinfectants, remove the disinfectant residue by wiping with a damp cloth.
- The surfaces must be dried immediately after disinfecting.

36.1.3 Removal of radioactive contaminants

- The agent must be specifically labelled as being an agent for removing radioactive contaminants.
- Ingredients of suitable agents for removing radioactive contaminants: anionic tensides, non-ionic tensides, polyhydrated ethanol.
- After removing the radioactive contaminants, remove the agent residue by wiping with a damp cloth.
- The surfaces must be dried directly after removing the radioactive contaminants.

36.2 Rotors and Attachments

36.2.1 Cleaning and care

- In order to prevent corrosion and material changes, rotors and accessories must be cleaned regularly with soap or a mild detergent and a damp cloth. Cleaning is recommended at least once a week. Contaminants must be removed immediately.
- Ingredients of suitable detergents:
soap, anionic tensides, non-ionic tensides.
- After using detergents, remove detergent residue by rinsing with water (only outside of the centrifuge) or wipe off with a damp cloth.
- The rotors and accessories must be dried directly after cleaning.
- Angle rotors, container and hanger made of aluminium are to be lightly greased after drying using acid-free grease, e.g. vaseline.
- In the case of biosafety systems (for further details of available biosafety systems see chapter "Anhang/Appendix, Rotoren und Zubehör/Rotors and accessories"), the packing rings must be checked and cleaned regularly (weekly). The sealing ring is to be replaced immediately upon indication of crack formation, embrittlement or abrasive wear. In order to prevent the packing ring from twisting when opening and closing the cover, the packing ring must be lightly rubbed with talcum powder or a rubber care product.
- In order to prevent corrosion as a result of moisture between the rotor and the motor shaft, the rotor should be disassembled and cleaned at least once a month, and the motor shaft should be lightly greased.
- The rotors and the accessory parts have to be checked on a monthly basis for wear and corrosion. For swing-out rotors, it is important to check the area of the lifting lugs, for hangers, the grooves and the base should be checked for cracks.



Rotors and attachments may no longer be utilised upon indication of wear and tear or corrosion.

- Check the firm seating of the rotor on a weekly basis.

36.2.2 Disinfection

- If infectious material should get on the rotors or accessories, they must be appropriately disinfected.
- Ingredients of suitable disinfectants:
glutaraldehyde, propanol, ethyl hexanol, anionic tensides, corrosion inhibitors.
- After using disinfectants, remove disinfectant residue by rinsing with water (only outside of the centrifuge) or wipe off with a damp cloth.
- The rotors and accessories must be dried directly after disinfection.

36.2.3 Removal of radioactive contaminants

- The agent must be specifically labelled as being an agent for the removal of radioactive contaminants.
- Ingredients of suitable agents for removing radioactive contaminants:
anionic tensides, non-ionic tensides, polyhydrated ethanol.
- After removing the radioactive contaminants, remove agent residue by rinsing with water (only outside of the centrifuge) or wipe off with a damp cloth.
- The rotors and accessories must be dried directly after removing the radioactive contaminants.

36.2.4 Trunnions

With swing-out rotors the trunnions must be regularly lubricated (Hettich Lubricating Grease No. 4051) in order to ensure consistent swinging out of the hangers.

36.2.5 Rotors and accessories with limited service lives

The use of certain rotors, hangers and accessory parts is limited by time.

These are marked with the maximum permitted number of operating cycles or with an expiration date and the maximum permitted number of operating cycles or just with the expiration date; e.g.:

- "einsetzbar bis Ende: IV. Quartal 2011 / usable until end of: IV. Quarter 2011" or
"einsetzbar bis Ende Monat/Jahr: 10/2011 / usable until end of month/year: 10/2011"
- "Max. Lauf Zyklen / max. cycles: 40000".



For safety reasons, rotors, hangers and accessory parts may no longer be used if either the indicated maximum number of operating cycles or the indicated expiration date has been reached.

The number of centrifuge operations can be queried; see the chapter on "Querying the operating hours and the number of centrifuge operations".

36.3 Autoclaving

Swing-out rotors, angle rotors made of aluminium, suspension made of metal, lids with bio-containment as well as stands and reductions can be autoclaved at 121° C / 250°F (20 mins).

Otherwise you must ask the manufacturer.

No statement can be made about the degree of sterility.



The lids of the rotors and containers must be removed prior to autoclaving.

Autoclaving accelerates the ageing process of plastics. In addition, autoclaving may discolour plastics.

We recommend that the packing rings of the bio-safety system be replaced after autoclaving.

36.4 Centrifuge containers

- With leakiness or after the breakage of centrifuging containers broken container parts and leaked centrifugation material are to be completely removed.
- The rubber inserts as well as the plastic sleeves of the rotors are to be replaced after a glass breakage.



Remaining glass splinters cause further glass breakage!

- If this concerns infectious material, a disinfection process is to be executed immediately.

37 Faults

If the fault cannot be eliminated with the help of the fault table, please inform Customer Service.

Please specify the type of centrifuge and the serial number. Both numbers can be found on the name plate of the centrifuge.



Perform a MAINS RESET:

- Switch off the mains switch (switch position "0").
- Wait at least 10 seconds and then switch on the mains switch again (switch position "1").

Message / fault		Cause	Remedy
No display		No voltage. Overvoltage protection tripped out. Triggering the automatic circuit breaker (only for types 1701-01 and 1706-01).	<ul style="list-style-type: none"> - Check supply voltage. - Switch automatic circuit breaker ON again; refer to Chapter "Switch on automatic circuit breaker" (only for types 1701-01 and 1706-01). - Mains switch ON.
TACHO - ERROR	1, 2, 96	Faulty speedometer. Motor, electronics defective.	<ul style="list-style-type: none"> - Open the cover. - Switch off the mains switch (switch position "0"). - Wait at least 10 seconds. - Turn the rotor vigorously by hand. - Switch on the mains switch again (switch position "1"). The rotor must turn during switch-on.
IMBALANCE		The rotor is unevenly loaded.	<ul style="list-style-type: none"> - Open lid. - Check the loading of the rotor, see chapter "Loading the rotor". - Repeat the centrifugation run.
CONTROL - ERROR	4.1 - 4.5, 6	Error in lid locking or lid closure.	<ul style="list-style-type: none"> - Perform a MAINS RESET.
N > MAX	5	Rotation too fast	
N < MIN	13	Rotation too slow	
ROTORCODE	10.1, 10.3	Incorrect rotor coding	
MAINS INTERRUPT		Power failure during the centrifugation run. (The centrifugation run was not finished.)	
VERSION-ERROR	12	Mismatch between electronic components Error / defect electronics	<ul style="list-style-type: none"> - Perform a MAINS RESET.
CONTROL-ERROR	22, 25.1-25.4	Error / defect electronics	
SER I/O - ERROR	31, 34, 36	Error / defect electronics	
° C * - ERROR	51, 53 - 55, 97,98	Error / defect electronics	
° C * - ERROR	52	Temperature is too high in overspeed room. Error / defect electronics	
FU / CCI - ERROR	60, 61.2-61.20, 61.128-61,131, 62	Error / defect electronics / motor	
FU / CCI - ERROR	61.1	Supply voltage is too low Error / defect electronics / motor	
			<ul style="list-style-type: none"> - Check supply voltage. - Perform a MAINS RESET.

Message / fault		Cause	Remedy
SENSOR-ERROR	90	Error / defect electronics	– Perform a MAINS RESET.
SENSOR-ERROR	91 - 93	Error / defect unbalance sensor	
NO ROTOR OR ROTORCODE ERROR		No rotor installed. Faulty speedometer.	– Open lid. – Install rotor.
WRONG ROTOR !!!		(for type 1701-30 only) A rotor is installed which isn't approved for type 1701-30.	– Open lid. – Install rotor 1798.
N > ROTOR MAX		Speed in the selected program greater than the maximum speed of the rotor.	– Check the set speed. Reduce the set speed
N > ROTOR MAX in Prog : e.g. 3		There is a program in the displayed program location whose speed is higher than the maximum speed of the rotor.	
Runtime 00:00 in Prog : e.g. 3		There is a continuous operation program in the displayed program location.	– Replace the continuous operation program in the program linkage with a program with preset time.
Empty Program		There is no program linkage saved on the displayed program location.	– Call up a program linkage.
FC INIT ERROR		Error / defect electronics	– Perform a MAINS RESET.
FC VERSION ERROR		Error / defect electronics	
FATAL EEPROM ERROR	1 - 5	Error / defect electronics	

38 Switch on automatic circuit breaker (only for types 1701-01 and 1706-01)

 Switch off the mains switch and separate the centrifuge from the mains!

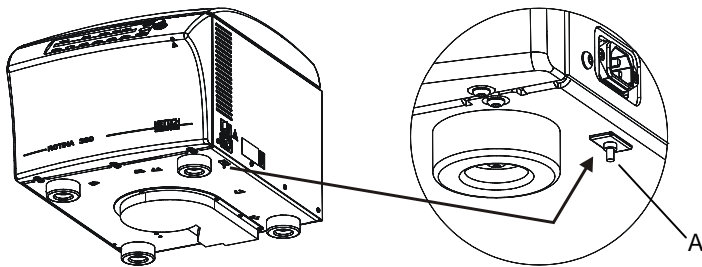

- Press the plastic pin (A) on the automatic circuit breaker.
- Reconnect the centrifuge to the mains supply.

39 Acceptance of the centrifuges for repair

If the centrifuge is returned to the manufacturer for repair, it must be decontaminated and cleaned to protect persons, environment and material.

We reserve the right to accept contaminated centrifuges.

Costs incurred for cleaning and disinfection are to be charged to the customer.

We ask for your understanding in this matter.

40 Disposal

Before disposal, the device must be decontaminated and cleaned to protect people, the environment and property.

When you are disposing of the device, the respective statutory rules must be observed.

Pursuant to guideline 2002/96/EC (WEEE), all devices supplied after August 13, 2005 may not be disposed as part of domestic waste. The device belongs to group 8 (medical devices) and is categorized in the business-to-business field.



The icon of the crossed-out trash can shows that the device may not be disposed as part of domestic waste.

The waste disposal guidelines of the individual EC countries might vary. If necessary, contact your supplier.

Table des matières

1	Usage conforme	57
2	Risques résiduels	57
3	Données techniques	57
4	Consignes de sécurité	58
5	Signification des symboles.....	59
6	Composition de la livraison	60
7	Déballer la centrifugeuse	60
8	Mise en service.....	60
9	Interface (uniquement pour les centrifugeuses avec interface).....	60
10	Ouvrir et fermer le couvercle	61
10.1	Ouvrir le couvercle	61
10.2	Fermer le couvercle	61
11	Montage et démontage du rotor	61
12	Chargement du rotor	62
13	Fermer le rotor à orientation libre de manière étanche aux aérosols	62
14	Organes de commande et indicateurs.....	63
14.1	Bouton de réglage.....	63
14.2	Touches et possibilités de réglage.....	63
15	Saisir les paramètres de centrifugation	64
15.1	Temps de marche	64
15.2	Vitesse de rotation (RPM)	65
15.3	Accélération centrifuge relative (RCF) et rayon de centrifugation (RAD)	65
15.3.1	Rayon de centrifugation (RAD)	65
15.3.2	Accélération centrifuge relative (RCF)	65
15.4	Paramètres de démarrage et de ralentissement	65
15.4.1	Niveau de démarrage	65
15.4.2	Niveau de freinage.....	65
15.4.3	Vitesse de rotation de l'arrêt freiné	65
15.5	Température (uniquement pour une centrifugeuse avec un refroidissement)	65
16	Programmation.....	65
16.1	Programmes paramétrés	66
16.2	Entrer ou modifier des programmes.....	66
16.3	Appeler des programmes.....	66
16.4	Protection en écriture pour programmes.....	66
16.5	Association de programmes.....	67
16.5.1	Activer ou désactiver association de programmes.....	67
16.5.2	Associer programmes ou modifier une association de programmes.....	67
16.5.3	Appeler association de programmes.....	67
16.6	Mémoire intermédiaire automatique.....	68
17	Centrifugation	68
17.1	Centrifugation avec présélection temps	68
17.2	Fonctionnement continu.....	69
17.3	Centrifugation de courte durée.....	69

18	Modifier les réglages pendant le cycle de centrifugation.....	69
19	Arrêt d'urgence.....	69
20	Signal acoustique.....	70
21	Données de centrifugation affichées après le démarrage.....	70
22	Régler l'unité de mesure de la température (uniquement pour une centrifugeuse avec un refroidissement)	70
23	Paramétrer verrouillage du programme.....	71
24	PIN (numéro d'identification personnel)	71
24.1	Régler ou modifier code PIN.....	72
24.2	Modifier code PIN oublié.....	72
25	Adresse de la centrifugeuse.....	72
26	Fonctions RCF-Integral et B-Ramp	72
27	Interrogation des heures de service et du nombre de cycles de centrifugation.....	73
28	Interrogation des informations sur le système.....	73
29	Affichage immédiat des données de centrifugation après le démarrage.....	73
30	Refroidissement (uniquement sur centrifugeuse avec refroidissement).....	73
30.1	Refroidissement en veilleuse	73
30.2	Pré-refroidissement du rotor	74
31	Chauffage (uniquement sur centrifugeuse avec l'option Chauffer/refroidir).....	74
32	Accélération centrifuge relative (RCF).....	74
33	Centrifugation de matières et de mélanges d'une densité supérieure à 1,2 kg/dm ³	75
34	Identification de rotor.....	75
35	Déverrouillage d'urgence	75
36	Entretien et maintenance	76
36.1	Centrifugeuse (boîtier, couvercle et cuve)	76
36.1.1	Entretien et nettoyage des surfaces	76
36.1.2	Désinfection des surfaces.....	76
36.1.3	Décontamination de substances radioactives.....	76
36.2	Rotors et accessoires	77
36.2.1	Nettoyage et entretien	77
36.2.2	Désinfection	77
36.2.3	Décontamination de substances radioactives.....	77
36.2.4	Goupilles de fixation	77
36.2.5	Rotors et accessoires à durée d'utilisation limitée	78
36.3	Autoclavage	78
36.4	Réservoirs de centrifugation	78
37	Défauts.....	79
38	Mettre le coupe-circuit automatique en service.....	80
39	Réparation des centrifugeuses.....	81
40	Élimination des déchets	81
41	Anhang / Appendix.....	108
41.1	Rotoren und Zubehör / Rotors and accessories.....	108
41.1.1	ROTINA 380 / 380 R, Typen / types 1701, 1701-01, 1706, 1706-01	108
41.1.2	ROTINA 380, Typ / type 1701-30	131

1 Usage conforme

La présente machine correspond à un produit de médecine (centrifugeuse de laboratoire) au sens de la directive IVD 98/79/EG. La centrifugeuse sert à séparer les substances ou les substances mélangées ayant une densité supérieure à 1,2 kg/dm³ au max. Cela concerne également les substances et les substances mélangées d'origine humaine. La centrifugeuse est uniquement destinée à cette utilisation. Tout usage autre ou dépassant ce contexte est considéré comme non-conforme. La société Andreas Hettich GmbH & Co. KG décline toute responsabilités pour les dégâts causés par un usage non-conforme.

L'usage conforme comprend également le respect des instructions du mode d'emploi et l'exécution des travaux d'inspection et de maintenance.

2 Risques résiduels

La machine est construite selon l'état de la technique et les règles de sécurité technique reconnues. Une utilisation et un maniement incorrect peuvent entraîner des risques de blessure et de décès pour l'utilisateur ou les tiers ou bien provoquer des dommages sur la machine ou les autres biens matériels. La machine doit uniquement être utilisée dans le cadre de son usage conforme et dans un état de sécurité technique irréprochable.

Il convient de dépanner immédiatement tout dérangement susceptible d'affecter la sécurité.

3 Données techniques

Fabricant	Andreas Hettich GmbH & Co. KG D-78532 Tuttlingen				
Modèle	ROTINA 380			ROTINA 380 R	
Type	1701-30	1701	1701-01	1706, 1706-50	1706-01
Tension du réseau (± 10%)	200-240 V 1~ / 100-127 V 1~	200-240 V 1~	100-127 V 1~	200-240 V 1~	110-127V 1~
Fréquence du réseau	50 – 60 Hz	50 – 60 Hz	50 – 60 Hz	50 – 60 Hz	60 Hz
Charge de connexion	max. 450 VA	650 VA	700 VA	1300 VA	1400 VA
Consommation de courant		3.3 A	7.0 A	6.5 A	13.0 A
Réfrigérant	----			R 404A	
Capacité max.	4 x 290 ml				
Densité admise	1.2 kg/dm ³				
Vitesse de rotation (RPM)	4000	15000			
Accélération (RCF)	3095	24400			
Energie cinétique	6200 Nm	18500 Nm		35000 Nm	
Obligation de contrôle (BGR 500)	non	oui			
Conditions ambiantes (EN / IEC 61010-1)	uniquement dans les intérieurs Jusqu'à 2000 m au dessus du niveau de la mer 2°C à 35°C 5°C à 35°C humidité de l'air max. relative 80% pour températures jusqu'à 31°C, décroissant en linéaire jusqu'à 50% de l'humidité relative pour 40°C.				
– Emplacement					
– Hauteur					
– Température ambiante					
– Humidité de l'air					
– Catégorie de surtension (IEC 60364-4-443)	II				
– Degré d'encrassement	2				
Catégorie de protection de l'appareil	I				
Non approprié pour l'usage dans un environnement exposé aux explosions.					
EMV					
– Emission de parasites, Résistance aux interférences	EN / IEC 61326-1, catégorie B; FCC Class B	EN / IEC 61326-1, catégorie B	FCC Class B	EN / IEC 61326-1, catégorie B	FCC Class B
Niveau du bruit (en fonction du rotor)	≤ 58 dB(A)	≤ 65 dB(A)		≤ 64 dB(A) ¹⁾	
Dimensions					
– Largeur	457 mm			457 mm	
– Profondeur	600 mm			750 mm	
– Hauteur	418 mm			418 mm	
Poids	env. 58.5 kg	env. 51 kg	env. 58.5 kg	env. 81 kg	env. 88.5 kg

1) pour rotor 1797 ≤ 70 dB(A)

4 Consignes de sécurité



Aucune demande garantie ne pourra être revendiquée auprès du fabricant si les indications données dans ce mode d'emploi ne sont pas toutes respectées.



- Veiller à la stabilité de la centrifugeuse.
- Avant d'utiliser la centrifugeuse, il est indispensable de vérifier la fixation correcte du rotor.
- Durant un processus de centrifugation, aucune personne, matière dangereuse et aucun objet ne doivent se trouver dans une zone de sécurité de 300 mm autour de la centrifugeuse selon EN / IEC 61010-2-020.
- Les rotors, balanciers et accessoires qui présentent d'importantes traces de corrosion ou des défauts mécaniques ou dont la durée d'utilisation a expiré ne doivent plus être utilisés.
- Suspended immédiatement l'utilisation de la centrifugeuse si la cuve de centrifugeuse présente des dommages susceptibles de porter atteinte à la sécurité.
- Les goupilles de fixation des rotors à amortissement doivent être graissées régulièrement (graisse de lubrification Hettich n° 4051) de manière à assurer le balancement régulier de la suspension.

- **Il importe de lire et de respecter le mode d'emploi avant la mise en service de la centrifugeuse. Seules les personnes ayant lu et compris le mode d'emploi sont autorisées à manipuler l'appareil.**
- Outre le mode d'emploi et les réglementations contraignantes relatives à la prévention des accidents, il importe également de respecter les règles spécifiques et communément admises en matière de sécurité et de travail. Le mode d'emploi doit être complété des dispositions nationales applicables à la prévention des accidents et à la protection de l'environnement.
- La centrifugeuse a été construite conformément à l'état actuel de la technique et son fonctionnement est sûr. Elle peut cependant présenter des dangers pour l'utilisateur ou des tiers si son utilisation n'est pas confiée à un personnel dûment formé, est inadéquate ou non conforme à sa destination.
- Pendant le fonctionnement, la centrifugeuse ne devra pas être déplacée ou être heurtée.
- En cas de défaillance ou en cas de déverrouillage d'urgence, ne jamais intervenir dans l'appareil lorsque le rotor tourne.
- Afin d'éviter les dommages causés par la condensation en passant d'un local froid à un local chaud, il faut soit réchauffer la centrifugeuse en la laissant pendant au moins 3 heures dans le local chaud avant de la raccorder au secteur, soit la faire fonctionner pendant 30 minutes dans le local froid pour la chauffer.
- Pour cet appareil, vous ne devez utiliser que des rotors et des accessoires homologués par le fabricant (voir chapitre "Anhang/Appendix, Rotoren und Zubehör/Rotors and accessories").
- Le rotor de la centrifugeuse doit uniquement être chargé conformément au chapitre "Chargement du rotor".
- Dans le cas de la centrifugation à la vitesse maximale, la densité des substances et des mélanges de substances ne doit pas excéder 1,2 kg/dm³.
- Il est interdit de procéder à des centrifugations en présence de défauts d'équilibrage.
- La centrifugeuse ne doit pas être exploitée dans un environnement explosif.
- Il est interdit de procéder à des centrifugations :
 - avec des matières inflammables ou explosives,
 - avec des matières susceptibles de réagir chimiquement ou de dégager d'importantes quantités d'énergie.
- En cas de centrifugation de substances dangereuses ou de substances mixtes toxiques, radioactives ou contaminées par des micro-organismes pathogènes, il incombe à l'utilisateur de prendre les mesures ad hoc. Il faut systématiquement utiliser des récipients de centrifugation avec des bouchons spéciaux à vis destinés aux substances dangereuses. Dans le cas des substances des groupes de risques 3 et 4, il faut utiliser un système de sécurité biologique en plus des récipients de centrifugation pouvant être obturés (voir le manuel "Laboratory Biosafety Manual" publié par l'Organisation Mondiale de la Santé). Dans un système de sécurité biologique, un joint biologique (bague d'étanchéité) empêche la fuite de gouttelettes et d'aérosols.

Lorsque la suspension d'un système de sécurité biologique est utilisée sans couvercle, il faut enlever la bague d'étanchéité de la suspension pour éviter de l'endommager pendant le cycle de centrifugation. Les bagues endommagées ne doivent plus être utilisées pour assurer l'étanchéité le système de sécurité biologique.

En l'absence d'un système de sécurité biologique, une centrifugeuse n'est pas étanche du point de vue microbiologique au sens de la norme EN / IEC 61010-2-020.

Pour ce qui concerne les systèmes à sécurité biologique, voir le chapitre "Anhang/Appendix, Rotoren und Zubehör/Rotors and accessories". Dans le doute vous pouvez obtenir les informations auprès du fabricant.

- Il est interdit de centrifuger des matières fortement corrosives pouvant réduire la résistance mécanique des rotors, des supports et des accessoires.
- Les réparations ne peuvent être effectuées que par une personne autorisée à cet effet par le fabricant.
- Utiliser uniquement les pièces de rechange originales et les accessoires d'origine homologués par les Etablissements Andreas Hettich GmbH & Co. KG.
- Les dispositions de sécurité suivantes font foi :
EN / IEC 61010-1 et EN / IEC 61010-2-020 ainsi que les dérogations nationales.
- La sécurité et la fiabilité de la centrifugeuse seront uniquement garanties si :
 - la centrifugeuse est utilisée conformément aux instructions du mode d'emploi,
 - l'installation électrique du site de la centrifugeuse est conforme aux prescriptions EN / IEC,
 - les contrôles prescrits selon BGV A1, BGR 500 sont effectués par un personnel spécialisé averti.

5 Signification des symboles



Symbole sur la machine:

Attention, zone de danger général.

Avant l'utilisation de la centrifuge, il est indispensable de lire le mode d'emploi et de respecter les consignes de sécurité !



Symbole dans ce document:

Attention, zone de danger général.

Ce symbole indique des consignes de sécurité et signale des situations pouvant être sources de danger. Le non-respect de ces instructions peut entraîner des dégâts matériels et personnels.



Symbole sur la machine et dans ce document:

Faire attention aux surfaces chaudes.

La non observance de ces indications peut conduire à des dommages matériels et corporels.



Symbole sur la machine et dans ce document:

Les balanciers à encoche en plastique doivent uniquement être utilisés avec des températures d'au maximum 40 °C / 104 °F.

La non observance de ces indications peut conduire à des dommages matériels et corporels.



Symbole sur la machine:

Équipotential : connecteur à fiche (connecteur L.E.P.) pour la liaison équipotentielle (uniquement pour une centrifugeuse avec un connecteur L.E.P.).



Symbole sur la machine:

Interface RS232 (uniquement pour centrifuge équipée d'une interface RS232).



Symbole sur la machine :

Coupe-circuit automatique (uniquement pour les types 1701-01 et 1706-01).



Symbole dans ce document:

Ce symbole signale des informations importantes.



Symbole sur la machine et dans ce document:

Symbole pour la collecte séparée des appareils électriques et électroniques, conformément à la directive 2002/96(EG (WEEE). L'appareil fait partie du groupe 8 (appareils de médecine).

Utilisation dans les pays de l'Union Européenne ainsi qu'en Norvège et en Suisse.

6 Composition de la livraison

- 1 Câble de connexion
- 1 Clé mâle coudée 5 mm
- 1 Graisse pour tourillon porteur
- 1 Mode d'emploi
- 1 Fiche de consignes pour le transport
- 1 CD (uniquement pour type 1701-30)

Le(s) rotor(s) et accessoires correspondant sont livrés selon les spécifications de la commande.

7 Déballer la centrifugeuse

- Soulever le carton et retirer le matériau d'amortissement.



Ne pas saisir sur le tableau de commande frontal pour soulever.
Tenir compte du poids de la centrifugeuse, voir au chapitre "Données techniques".

Avec un nombre suffisant d'aides, soulever la centrifugeuse sur les deux faces et la déposer sur la table de laboratoire.

8 Mise en service

- Selon la norme sur les appareils de laboratoire EN / IEC 61010-2-020, l'installation locale doit être équipée d'un interrupteur d'arrêt d'urgence pour sectionner l'alimentation du secteur en cas de défaut. Cet interrupteur doit être éloigné de la centrifugeuse, de préférence hors de la pièce dans laquelle est la centrifugeuse ou près de la porte.
- **Placer la centrifugeuse sur un emplacement approprié de manière à ce qu'elle soit stable et mettre de niveau. Lors de la mise en place, il faut respecter la zone de sécurité exigée de 300mm autour de la centrifugeuse selon EN / IEC 61010-2-020.**



Durant un processus de centrifugation, aucune personne, matière dangereuse et aucun objet ne doivent se trouver dans une zone de sécurité de 300 mm autour de la centrifugeuse selon EN / IEC 61010-2-020.

- Ne pas placer d'objet devant la grille de ventilation.
Ménager un espace de ventilation de 300 mm autour de la grille.
- Centrifugeuse avec un connecteur L.E.P. :
relier en cas de besoin le connecteur L.E.P. au dos de l'appareil à un système médical de liaison équipotentielle supplémentaire.
- Centrifugeuse équipée d'une interface RS232:
Branchez l'interface RS232 de la centrifugeuse sur le PC avec une nappe de connexion RS232 (non comprise dans la livraison).
- Vérifier que la tension de secteur est identique à la mention de la plaque signalétique.
- Raccorder la centrifugeuse à une prise de secteur normalisée au moyen du câble de connexion. Puissance connectée voir chapitre "Données techniques".
- Fermer l'interrupteur de secteur (position de l'interrupteur "I"). Les DEL des touches clignotent. Les indications suivantes apparaissent les unes après les autres :
 1. Le modèle de la centrifugeuse ;
 2. La version du programme ;
 3. Le code du rotor (Rotor), la vitesse maximale de rotation du rotor (Nmax) et le rayon de centrifugation fixé à l'avance (R) du dernier rotor reconnu par l'identification du rotor.
 4. **⚡ OPEN ⚡ OEFFNEN**
- Ouvrir le capot.
Les données de centrifuge du dernier programme utilisé ou du programme 1 s'affichent.
- Enlever la sécurité de transport (voir la fiche de consignes "Sécurité de transport").

9 Interface (uniquement pour les centrifugeuses avec interface)

En option, l'appareil peut être équipé d'une interface série RS232.

L'interface RS232 est désignée par le symbole 

Via cette interface, vous pouvez commander la centrifugeuse et chercher des données. Le DEL de la touche  brille pendant le transfert de données.

10 Ouvrir et fermer le couvercle

10.1 Ouvrir le couvercle



Le capot ne peut être ouvert que lorsque la centrifugeuse est sous tension et que le rotor est à l'arrêt. Dans les autres cas, voir le chapitre, "Déverrouillage d'urgence".

- Appuyer sur la touche **OPEN / STOP**. Le couvercle est déverrouillé par le moteur et la DEL gauche située dans la touche **OPEN / STOP** s'éteint.

10.2 Fermer le couvercle



Ne pas mettre les doigts entre le couvercle et le boîtier.
Ne pas laisser tomber le couvercle pour le fermer.

Lorsque la DEL gauche de la touche **OPEN / STOP** clignote, appuyer la touche **OPEN / STOP** pour amener le verrouillage motorisé du couvercle en position de base (ouvert).

- Mettre le couvercle en place et appuyer légèrement sur la bordure avant du couvercle. Le verrouillage est automatique. La DEL de gauche intégrée dans la touche **OPEN / STOP** s'allume.

11 Montage et démontage du rotor

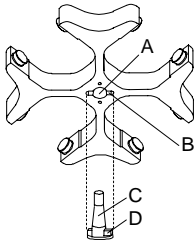

- Nettoyer l'arbre d'entraînement (C) et l'alésage du rotor (A) et enduire ensuite l'arbre d'entraînement d'une pellicule de graisse. Les particules d'impuretés entre l'arbre d'entraînement et le rotor réduisent la stabilité d'assise du rotor et provoquent un fonctionnement irrégulier.
- Enficher le rotor à la verticale sur l'arbre d'entraînement. Le taquet de l'arbre d'entraînement (D) doit être logé dans la rainure du rotor (B). L'orientation de la rainure est indiquée sur le rotor.
- Serrer l'écrou de fixation du rotor avec la clé de la livraison en tournant dans le sens horloger.
- Vérifier la stabilité d'assise du rotor.
- Démontage du rotor: Desserrer l'écrou de fixation par rotation dans le sens anti-horloger jusqu'à ce que le rotor puisse être détaché par pression. En exerçant une légère pression, détacher le rotor du cône de l'arbre d'entraînement. Dévisser l'écrou de fixation jusqu'à ce que le rotor soit détaché de l'arbre d'entraînement.

12 Chargement du rotor



Des récipients standard de centrifugation en verre sont résistants jusqu' à un ACR de 4000 (DIN 58970, partie 2).

- Vérifier la stabilité d'assise du rotor.
Dans le cas des rotors à balanciers, toutes les positions des rotors doivent être équipées avec les **mêmes** balanciers. Certains balanciers sont désignés avec le numéro de la place du rotor. Ces balanciers doivent exclusivement être installés dans la place de rotor correspondante.
Les balanciers désignés par un numéro de set, comme S001/4 par exemple, doivent exclusivement être utilisés dans le set.
- Le chargement des rotors et des balanciers doit être nécessairement symétrique. Les conteneurs de centrifugation doivent être uniformément répartis sur toutes les positions du rotor. Pour les combinaisons possibles, voir le Chapitre "Anhang/Appendix, Rotoren und Zubehör/Rotors and accessories".
Dans le cas des rotors à angle fixe, il faut charger tous les logements possibles du rotor, voir au chapitre "Annexe/Appendix, Rotors et accessoires/Rotors and accessories".

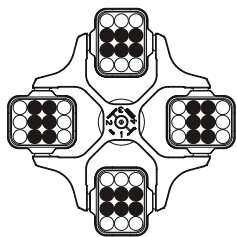

Rotor uniformément chargé

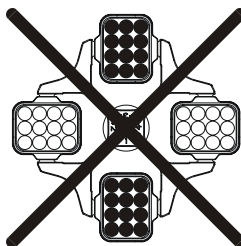

Non autorisé !
Rotor irrégulièrement chargé

- Certains dispositifs de suspension indiquent soit le poids maximum de la charge, soit le poids total maximum comprenant charge et dispositifs. Pour les cas d'exception, voir le chapitre "Centrifugation de matières et de mélanges d'une densité supérieure à 1,2 kg/dm³". L'indication du poids de la charge maximale comprend le poids total de la réduction, châssis, récipient de centrifugation et contenu.
- Dans le cas des récipients à garniture de caoutchouc, les récipients de centrifugation doivent avoir le même nombre de garnitures dans la partie inférieure.
- Les récipients de centrifugation doivent toujours être remplis hors de la centrifugeuse.
- Aucun liquide ne doit parvenir dans le bol de centrifugeuse pendant le remplissage et le déplacement des balanciers.
- La quantité maximale de remplissage indiquée par le fabricant pour les récipients de centrifugation ne doit pas être dépassée.
- La hauteur de remplissage des récipients sera autant que possible égale pour maintenir les différences de poids entre les récipients de centrifugation aussi réduites que possible .

13 Fermer le rotor à orientation libre de manière étanche aux aérosols

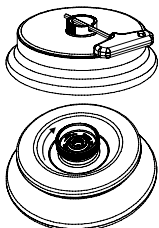

Afin de garantir l'étanchéité aux aérosols, le couvercle d'un rotor avec tube à orientation libre étanche aux aérosols doit être correctement fermé.

Ceci s'effectue en insérant la clé livrée dans la fourchette dans l'orifice de la poignée béquille. Si la poignée béquille ne possède pas d'orifice, le couvercle doit être fermé correctement à la main en tournant la poignée dans le sens des aiguilles d'une montre.

Rotors à orientation libre disponibles, voir chapitre "Anhang/Appendix, Rotoren und Zubehör/Rotors and accessories".

14 Organes de commande et indicateurs

Voir illustration sur la page 2.

Fig. 2, Fig. 3: Console des indicateurs et organes de commande

14.1 Bouton de réglage



Pour le réglage des paramètres individuels.

Pour faire décroître la valeur, tourner le bouton dans le sens anti-horaire. Pour augmenter la valeur, tourner le bouton dans le sens horaire.

14.2 Touches et possibilités de réglage



- Temps de marche, paramètre **t/hms**.
h: heures. Réglable de 1 h à 99 h, par incrément de 1 heure.
m: minutes. Réglable de 1 min à 59 min, par incrément de 1 minute.
s: secondes. Réglable de 1 s à 59 s, par incrément de 1 seconde.
- Fonctionnement continu " ∞ "



- Vitesse de rotation, paramètre **RPM**.
 Réglable de 50 RPM à la vitesse maximale de rotation du rotor (Nmax), par incrément de 10. Pour la vitesse de rotation maximale du rotor, voir au chapitre "Annexe/Appendix, Rotors et accessoires/Rotors and accessories".



- Accélération centrifuge relative, paramètre **RCF**.
 Le RCF s'affiche entre parenthèses $\langle \rangle$. La DEL de la touche brille.
 Une valeur numérique indiquant une vitesse de rotation entre 50 RPM et la vitesse maximale de rotation du rotor (Nmax) peut être choisie. Réglable par incrément de 1.
- Rayon de centrifugation, paramètre **RAD**.
 Réglable de 85 mm à 330 mm, par incrément de 1 millimètre. Pour le rayon de centrifugation, voir au chapitre "Annexe/Appendix, Rotors et accessoires/Rotors and accessories".





Paramètres de démarrage et de ralentissement

- Niveaux de démarrage, paramètre ↗ .
 Niveau 9 = le temps de démarrage le plus court,... Niveau 1 = le temps de démarrage le plus long.
- Niveau de freinage, paramètre ↘ .
 Niveau 9 = le temps de ralentissement le plus court,... Niveau 1 = long temps de ralentissement, niveau 0 = ralentissement sans freinage.
- Vitesse de rotation de l'arrêt freiné, paramètre **N Brake**.
 Réglable de 50 RPM à la vitesse maximale de rotation du rotor (Nmax), par incrément de 10.
 Le ralentissement sans freinage a lieu une fois que cette vitesse de rotation est atteinte.



- Température (uniquement pour une centrifugeuse avec un refroidissement)
 Réglable en degré Celsius (°C) ou en degré Fahrenheit (°F). Pour le réglage de l'unité de mesure de la température, voir au chapitre "Régler l'unité de mesure de la température".
 Paramètre **T/°C** = degré Celsius (°C).
 Réglable de - 20 °C à + 40 °C, par incrément de 1 °C (en cas d'option Chauffage/Refroidissement, réglable de - 20 °C à + 90 °C).
 Paramètre **T/°F** = degré Fahrenheit (°F).
 Réglable de - 4 °F à + 104 °F, par incrément de 1 °F (en cas d'option Chauffage/Refroidissement, réglable de - 4 °F à + 194 °F).
 La plus basse température pouvant être atteinte dépend du rotor (voir au chapitre "Annexe/Appendix, Rotors et accessoires/Rotors and accessories").

- 
 - Appeler programmes et associations de programmes, paramètre **RCL**.
Programmes: emplacements de programme 1 à 99 et PREC. Associations de programmes: emplacements de programme A à Z.
 - Enregistrer programmes et associations de programmes, paramètre **STO**.
Il est possible de sauvegarder 99 programmes (avec une centrifugeuse sans refroidissement : positions de programme de 1 à 99, avec une centrifugeuse avec un refroidissement : positions de programme de 1 à 98 et PREC). La position de programme PREC (PRECOOLING) est réservée au programme de prérefroidissement. La position de programme 0 sert de mémoire intermédiaire pour les données de centrifugation du dernier cycle de centrifugation ayant eu lieu. Aucun programme ne peut être sauvegardé dans cette position de programme.
Vous pouvez enregistrer 25 associations de programmes (emplacements de programme A à Z, l'emplacement J n'existe pas). Une association de programmes peut se composer de 20 programmes.
 - Associer programmes, paramètre **EDIT**.
 - Appeler le "menu Machine" (maintenir la touche enfoncée pendant 8 secondes) et sélectionner les paramètres dans ce menu.

- 
 - Démarrer le prérefroidissement du rotor (uniquement pour une centrifugeuse avec un refroidissement). La DEL de la touche est allumée pendant le cycle de centrifugation, tant que le rotor tourne. Le prérefroidissement du rotor s'effectue automatiquement avec le programme **PREC** (PRECOOLING).

- 
 - Démarrer le cycle de centrifugation. La DEL de la touche est allumée pendant le cycle de centrifugation, tant que le rotor tourne.
 - Centrifugation de courte durée.
Le cycle de centrifugation a lieu tant que la touche est maintenue enfoncée. La DEL de la touche est allumée pendant le cycle de centrifugation, tant que le rotor tourne.
 - Sauvegarder les saisies et les modifications.

- 
 - Terminer le cycle de centrifugation.
Rotation par inertie du rotor selon les paramètres de rotation par inertie présélectionnés. La DEL intégrée dans la touche, à droite, reste allumée jusqu'à l'arrêt du rotor. A l'arrêt du rotor, la DEL gauche intégrée dans la touche clignote. L'ARRET D'URGENCE est activé en appuyant deux fois sur la touche.
 - Déverrouiller le couvercle.
La DEL de gauche intégrée dans la touche s'éteint.
 - Quitter la saisie des paramètres et le "menu Machine".

15 Saisir les paramètres de centrifugation



Après sélection de paramètres et pendant la sélection des paramètres, l'indicateur bascule sur les valeurs précédentes si aucune action n'exécute sur les touches pendant 8 secondes. Il est alors nécessaire de recommencer la saisie des paramètres.

En cas de saisie de plusieurs paramètres, il faut appuyer sur la touche **START** seulement après le réglage du dernier paramètre.

Lorsque des paramètres sont modifiés, le numéro de position du programme s'affiche entre parenthèses (). Cela signifie que les données de centrifugation de l'affichage ne correspondent plus aux données de centrifugation sauvegardées de la position du programme.

La saisie des paramètres peut être interrompue à tout moment en appuyant sur la touche **OPEN/STOP**. Dans ce cas, les réglages ne sont pas sauvegardés.



15.1 Temps de marche



Pour régler le fonctionnement continu, il faut mettre les minutes, les secondes et les heures à zéro. Le fonctionnement continu est indiqué dans l'affichage par le symbole "∞".



- Appuyer sur la touche **TIME**. Le paramètre **t/hms** s'affiche. Les minutes (**m**) sont représentées entre parenthèses < > et peuvent être modifiées.
- Régler la valeur souhaitée avec le bouton de réglage **○**.
- Appuyer sur la touche **TIME**. Les secondes (**s**) sont représentées entre parenthèses < > et peuvent être modifiées.
- Régler la valeur souhaitée avec le bouton de réglage **○**.
- Appuyer sur la touche **TIME**. Les heures (**h**) sont représentées entre parenthèses < > et peuvent être modifiées.
- Régler la valeur souhaitée avec le bouton de réglage **○**.
- Appuyer sur la touche **START** pour reprendre le réglage dans l'affichage.

15.2 Vitesse de rotation (RPM)

- Appuyer sur la touche . Le paramètre **RPM** s'affiche.
- Régler la valeur souhaitée avec le bouton de réglage .
- Appuyer sur la touche  pour reprendre le réglage dans l'affichage.

15.3 Accélération centrifuge relative (RCF) et rayon de centrifugation (RAD)



15.3.1 Rayon de centrifugation (RAD)

- Appuyez la touche  jusqu'à ce que les paramètres **RAD** et **RCF** s'affichent, par ex. **RAD = 146 -> RCF = 3695**. La DEL de la touche s'allume.
- Régler le rayon de centrifugation souhaité avec le bouton de réglage . La modification du rayon de centrifugation change automatiquement la valeur de la RCF.
- Appuyer sur la touche  pour reprendre le réglage dans l'affichage.

15.3.2 Accélération centrifuge relative (RCF)







L'accélération relative de la centrifugeuse (RCF) dépend du rayon de centrifuge. Avant de régler l'accélération RCF, réglez le rayon de centrifuge, voir chapitre "Rayon de centrifuge (RAD)".





- Appuyez la touche  jusqu'à ce que les paramètres **RCF** et **RAD** s'affichent, par ex. **RCF = 3695 RAD = 146**. La DEL de la touche s'allume.
- Régler la RCF souhaitée avec le bouton de réglage .
- Appuyer sur la touche  pour reprendre le réglage dans l'affichage.

15.4 Paramètres de démarrage et de ralentissement



15.4.1 Niveau de démarrage

- Appuyer sur la touche  jusqu'à ce que le paramètre  s'affiche.
- Régler le niveau souhaité avec le bouton de réglage .
- Appuyer sur la touche  pour reprendre le réglage dans l'affichage.

15.4.2 Niveau de freinage

- Appuyer sur la touche  jusqu'à ce que le paramètre  s'affiche.
- Régler le niveau souhaité avec le bouton de réglage .
- Appuyer sur la touche  pour reprendre le réglage dans l'affichage.



15.4.3 Vitesse de rotation de l'arrêt freiné

- Appuyer sur la touche  jusqu'à ce que le paramètre **N Brake** s'affiche.
- Régler la valeur souhaitée avec le bouton de réglage .
- Appuyer sur la touche  pour reprendre le réglage dans l'affichage.

15.5 Température (uniquement pour une centrifugeuse avec un refroidissement)



La température peut être saisie en degré Celsius (°C) ou en degré Fahrenheit (°F). Pour le réglage de l'unité de mesure de la température, voir au chapitre "Régler l'unité de mesure de la température".

- Appuyer sur la touche . Le paramètre **T/°C** ou **T/°F** s'affiche.
- Régler la valeur souhaitée avec le bouton de réglage .
- Appuyer sur la touche  pour reprendre le réglage dans l'affichage.

16 Programmation



Lorsque des paramètres sont modifiés, le numéro de position du programme s'affiche entre parenthèses (). Cela signifie que les données de centrifugation de l'affichage ne correspondent plus aux données de centrifugation sauvegardées de la position du programme.

16.1 Programmes paramétrés (uniquement pour le type 1701-30)



Les programmes 1 à 4 sont pré-programmés et protégés en écriture.

Si vous tentez d'enregistrer des données sur les emplacements de programmes 1 à 4, le système affiche "**Protected !!**" et empêche l'enregistrement des données.

A l'appel du programme, pour les emplacements 1 à 4, le symbole "+" s'affiche pour signaler que ces données sont protégées en écriture.

Supprimez la protection en écriture pour modifier et enregistrer les données des emplacements 1 à 4. Toutefois, l'enregistrement ne sera que temporaire, les données modifiées seront perdues à la déconnexion de l'appareil.

PROG 1		PROG 2		PROG 3		PROG 4	
RAD	155	RAD	155	RAD	155	RAD	155
RCF	200	RCF	800	RCF	600	RCF	600
RPM	1074	RPM	2149	RPM	1861	RPM	1861
Temps de marche	2:15	Temps de marche	10:15	Temps de marche	10:15	Temps de marche	5:15
	9		9		9		9
	0		6		6		6

16.2 Entrer ou modifier des programmes

- Régler les paramètres souhaités (voir au chapitre "Saisir les paramètres de centrifugation").
- Appuyer sur la touche **PROG** jusqu'à ce que le paramètre **STO** s'affiche.
- Régler la position de programme souhaitée avec le bouton de réglage **○**.



Si le symbole "+" est affiché derrière l'emplacement de programme, cela signifie que les données sont protégées en écriture. Dans ce cas, il faut d'abord supprimer la protection en écriture avant de pouvoir enregistrer (voir chapitre "Protection en écriture pour programmes").

- Appuyer sur la touche **START** pour sauvegarder les réglages dans la position souhaitée du programme. **Program store ..** s'affiche brièvement à titre de confirmation.



Les données préalables de l'emplacement du programme seront écrasées à l'enregistrement. Si "**Protected !!**" s'affiche, cela signifie que les données de l'emplacement de programme sont protégées en écriture et qu'elles ne seront pas enregistrées.

16.3 Appeler des programmes

- Appuyer sur la touche **PROG**. Le paramètre **RCL** s'affiche.
- Régler la position de programme souhaitée avec le bouton de réglage **○**.



Si le symbole "+" est affiché derrière l'emplacement de programme, cela signifie que les données sont protégées en écriture.

- Appuyer sur la touche **START**. **Program recall ..** s'affiche brièvement à titre de confirmation. Les données de la centrifugation de la position appelée du programme s'affichent.

16.4 Protection en écriture pour programmes

Vous pouvez verrouiller les programmes afin d'empêcher toute modification arbitraire ou accidentelle.

Lorsque le rotor est à l'arrêt, vous pouvez activer ou désactiver la protection en écriture en procédant comme suit:

- Appeler le programme souhaité (voir chapitre "Appeler programmes").
- Appuyer sur la touche **PROG**. Le paramètre **RCL** s'affiche.
- Appuyez la touche **PROG** pendant 8 secondes. Au bout de 8 secondes, le message **Set Protection = 1-** par ex. s'affiche.
- Avec le bouton rotatif **○**, réglez "+" ou "-".
 - + = programme protégé en écriture,
 - = programme non protégé en écriture.
- Appuyez la touche **START** pour enregistrer le réglage.

16.5 Association de programmes

L'association de programmes vous permet d'associer plusieurs cycles de centrifugation entre eux.



Une association de programmes n'est possible que si celle-ci est activée (paramètre **Multi programs = on**; voir chapitre "Activer ou désactiver association de programmes").

16.5.1 Activer ou désactiver association de programmes

Lorsque le rotor est à l'arrêt, vous pouvez activer ou désactiver l'association des programmes en procédant comme suit :

- Maintenir la touche **PROG** enfoncée pendant 8 secondes.
Le ***** Machine Menu ***** s'affiche après 8 secondes.
- Appuyer sur la touche **PROG** jusqu'à ce que **-> Settings** s'affiche.
- Appuyer sur la touche **START**. **SOUND / BELL = off/on** s'affiche.
- Appuyer sur la touche **PROG** jusqu'à ce que s'affiche **Multi programs = off/on**.
- Avec le bouton rotatif, **○** régler **off** ou **on**.
off = association de programmes désactivée,
on = association de programmes activée.
- Appuyer sur la touche **START** pour sauvegarder le réglage.
Store Settings ... et ensuite **-> Settings** s'affichent brièvement à titre de confirmation.
- Appuyer 1 x sur la touche **OPEN/STOP** pour quitter le menu "Settings" ou appuyer 2 x sur la touche **OPEN/STOP** pour quitter le "menu Machine".

16.5.2 Associer programmes ou modifier une association de programmes



Vous pouvez enregistrer 25 associations de programmes (emplacements de programme A à Z, l'emplacement J n'existe pas). Une association de programmes peut se composer de maximum 20 programmes.

Dans une association de programmes, la vitesse de rotation s'adapte toujours d'un programme à l'autre avec le paramètre de démarrage du programme qui suit.

Une association de programmes ne doit pas comporter de programmes de fonctionnement continu.

Dans une association de programmes, vous ne pouvez pas modifier de paramètre de centrifugation. Une modification des paramètres n'est possible que dans les programmes individuels.

Avec la touche **TIME**, vous pouvez demander, pendant le cycle de centrifugation, la durée totale de l'association de programmes (par ex. $\Sigma=00:05:30$) ainsi que la durée du programme en cours (par ex. **t B.02=00:01:00**).

1. Appuyez la touche **PROG** jusqu'à ce que le paramètre **EDIT A...Z** s'affiche.
2. Avec le bouton rotatif **○**, réglez l'emplacement où vous souhaitez enregistrer l'association de programmes.
3. Appuyez la touche **START**. L'emplacement de l'association de programmes et le premier programme de l'association s'affichent, par ex. **EDIT B.01 = 01**.
4. Avec le bouton rotatif **○**, réglez le premier programme de l'association.
5. Appuyez la touche **PROG**. Le programme associé suivant s'affiche, par ex. **EDIT B.02 = END**.
6. Avec le bouton rotatif **○**, réglez le programme associé suivant.
7. Appuyez la touche **PROG**. Le programme associé suivant s'affiche, par ex. **EDIT B.03 = END**.
8. Répétez les étapes 6 et 7 jusqu'à ce que tous les programmes soient paramétrés.
9. Avec le bouton rotatif **○**, réglez **END** (en tournant le bouton dans le sens inverse des aiguilles d'une montre).



Pour les associations composées de 20 programmes, vous ne pouvez pas régler **END** après le 20ème programme.

10. Appuyez la touche **START**. **STO B** s'affiche par exemple.
11. Appuyez la touche **START** pour enregistrer l'association de programmes.
Le système confirme l'action en affichant brièvement **Multi program store ..**

16.5.3 Appeler association de programmes

- Appuyez la touche **PROG** jusqu'à ce que le paramètre **RCL A...Z** s'affiche.
- Régler la position de programme souhaitée avec le bouton de réglage **○**.
- Appuyer sur la touche **START**. **Multi program recall ..** s'affiche brièvement à titre de confirmation.
Les données de centrifugation du premier programme de l'association de programmes s'affichent.

16.6 Mémoire intermédiaire automatique

La position de programme 0 sert de mémoire intermédiaire pour les données de centrifugation du dernier cycle de centrifugation ayant eu lieu.

Aucun programme ne peut être sauvegardé dans cette position de programme.

Après chaque démarrage d'un cycle de centrifugation, les données de centrifugation utilisées pour le cycle sont automatiquement sauvegardées dans la position de programme "0" et peuvent être appelées.

17 Centrifugation



Durant un processus de centrifugation, aucune personne, matière dangereuse et aucun objet ne doivent se trouver dans une zone de sécurité de 300 mm autour de la centrifugeuse selon EN / IEC 61010-2-020.



L'entraînement est stoppé en phase de montée en puissance si la différence de tare admissible a été dépassée pendant le chargement du rotor, et la mention **IMBALANCE** est affichée.

Si la vitesse de rotation du programme sélectionné est supérieure à la vitesse de rotation maximale du rotor (Nmax), aucun processus de centrifugation ne peut être lancé. Le programme affiche **N > ROTOR MAX** (se reporter au chapitre "Défauts").

Si, pour des associations de programmes **N > ROTOR MAX en Prog** : par ex. **5, Runtime 00:00 en Prog** : par ex. **5** ou **Empty Program** s'affiche, vous ne pouvez pas lancer de centrifugation (voir chapitre "Défauts").

La centrifugation peut être stoppée n'importe quand en appuyant sur la touche **OPEN/STOP**.

Il est possible de sélectionner et de modifier tous les paramètres pendant la centrifugation (voir le Chapitre "Saisir les paramètres de centrifugation. ").

Les touches **RPM** et **RCF** permettent de commuter à tout moment entre les affichages RPM et RCF. Il n'est pas possible de commuter lorsque vous travaillez avec des associations de programmes.

Lorsque le travail est effectué avec l'affichage RCF, il est impératif d'entrer le rayon de centrifugation.

Après affichage de **OPEN OEFFNEN** (= OUVRIR) la commande de centrifugeuse n'est possible qu'après avoir ouvert le couvercle une fois.

En cas de changement du rotor, il n'y a pas de cycle de centrifugation et l'affichage indique par ex. **Rotor 4 Nmax= 4500 R=184 mm** (voir au chapitre "Identification de rotor").

Erreurs de commande et dérangements s'affichent (se reporter au chapitre "Défauts").

- Activer l'interrupteur secteur. Position de l'interrupteur I.
- Charger le rotor et fermer le couvercle de la centrifugeuse.

17.1 Centrifugation avec présélection temps

- Régler une durée de marche, appeler un programme avec présélection temps ou une association de programmes (voir chapitre "Saisir les paramètres de centrifugation", "Appeler des programmes" ou "Association de programmes").
- Régler une durée ou appeler un programme avec une présélection de la durée (voir au chapitre "Saisir les paramètres de centrifugation" ou "Appel du programme").
- Appuyer sur la touche **START**. La DEL de la touche **START** clignote jusqu'à ce que le rotor soit lu, la DEL clignote ensuite.
- Après l'expiration de la durée ou l'interruption du cycle de centrifugation en appuyant sur la touche **OPEN/STOP**, le ralentissement a lieu avec le niveau de freinage réglé. Le paramètre de ralentissement s'affiche, par ex. **9**. La DEL droite de la touche **OPEN/STOP** s'allume. Après l'immobilisation du rotor, la DEL de la touche **START** s'éteint et **OPEN OEFFNEN** s'affiche. La DEL droite de la touche **OPEN/STOP** s'éteint également, la DEL gauche de la touche **OPEN/STOP** commence à clignoter jusqu'à ce que le couvercle s'ouvre.

Durant le processus de centrifugation, la vitesse de rotation du rotor ou la valeur RCF en résultant, ainsi que la température des échantillons (uniquement dans le cas des centrifugeuses avec réfrigération) et le temps restant, sont affichés.

17.2 Fonctionnement continu

- Mettre les minutes, les secondes et les heures à "0" ou appeler un programme de fonctionnement continu (voir au chapitre "Saisir les paramètres de centrifugation" ou "Appeler des programmes").
- Appuyer sur la touche **START**. La DEL de la touche **START** clignote jusqu'à ce que le rotor soit lu, la DEL clignote ensuite. Le chronométrage commence à 00:00.
- Appuyer sur la touche **OPEN/STOP** pour terminer le cycle de centrifugation. Le ralentissement s'effectue avec le paramètre de ralentissement appelé. Le paramètre de ralentissement s'affiche, par ex. **9**. La DEL droite de la touche **OPEN/STOP** s'allume. Après l'immobilisation du rotor, la DEL de la touche **START** s'éteint et **OPEN OEFFNEN** s'affiche. La DEL droite de la touche **OPEN/STOP** s'éteint également, la DEL gauche de la touche **OPEN/STOP** commence à clignoter jusqu'à ce que le couvercle s'ouvre.

Durant le processus de centrifugation, la vitesse de rotation du rotor ou la valeur RCF en résultant, ainsi que la température des échantillons (uniquement dans le cas des centrifugeuses avec réfrigération) et le temps écoulé, sont affichés.

17.3 Centrifugation de courte durée



Une centrifugation brève n'est pas possible lorsque vous travaillez avec des associations de programmes.

- Maintenir la touche **START** enfoncée. La DEL de la touche **START** clignote jusqu'à ce que le rotor soit lu, la DEL clignote ensuite. Le chronométrage commence à 00:00.
- Relâcher la touche **START** pour terminer le cycle de centrifugation. Le ralentissement s'effectue avec le paramètre de ralentissement appelé. Le paramètre de ralentissement s'affiche, par ex. **9**. La DEL droite de la touche **OPEN/STOP** s'allume. Après l'immobilisation du rotor, la DEL de la touche **START** s'éteint et **OPEN OEFFNEN** s'affiche. La DEL droite de la touche **OPEN/STOP** s'éteint également, la DEL gauche de la touche **OPEN/STOP** commence à clignoter jusqu'à ce que le couvercle s'ouvre.

Durant le processus de centrifugation, la vitesse de rotation du rotor ou la valeur RCF en résultant, ainsi que la température des échantillons (uniquement dans le cas des centrifugeuses avec réfrigération) et le temps écoulé, sont affichés.

18 Modifier les réglages pendant le cycle de centrifugation



Il n'est pas possible de modifier des réglages pendant la centrifugation lorsque vous travaillez avec des associations de programmes.

La durée de fonctionnement, la vitesse de rotation, l'accélération relative de centrifugation (RCF), rayon de centrifugation, les paramètres de démarrage et de rotation par inertie, ainsi que la température (uniquement dans le cas des centrifugeuses avec réfrigération) peuvent être modifiés pendant le processus de centrifugation.

- Appeler le paramètre souhaité et modifier la valeur avec le bouton de réglage **○** (voir au chapitre "Saisir les paramètres de centrifugation").
- Appuyer sur la touche **START**. Le réglage modifié est sauvegardé dans la position de programme "0" (voir au chapitre "Mémoire intermédiaire automatique"). Le numéro de la position de programme est affiché entre parenthèses (). Le programme d'origine n'est pas écrasé.

19 Arrêt d'urgence

- Appuyer 2x sur la touche **OPEN/STOP**.

En cas d'arrêt d'urgence, le ralentissement a lieu avec le niveau de freinage 9 (le plus court temps de ralentissement). Le niveau de freinage **9** est affiché. Si le niveau de freinage 0 a été fixé à l'avance, le ralentissement a alors lieu avec le niveau de freinage **9d**. Pour des raisons techniques, le temps de ralentissement est plus long avec le niveau de freinage 9d qu'avec le niveau de freinage 9.

20 Signal acoustique

Le signal sonore retentit :

- en présence d'un défaut à un intervalle de 2 s.
- au terme de la centrifugation et après immobilisation du rotor, à un intervalle de 30 s.

Le signal sonore cesse après ouverture du couvercle, en appuyant sur une touche quelconque.

Pour activer / désactiver le signal sonore après la centrifugation, alors que le rotor est immobilisé, procéder comme suit :

- Maintenir la touche **PROG** enfoncée pendant 8 secondes.
Le ***** Machine Menu ***** s'affiche après 8 secondes.
- Appuyer sur la touche **PROG** jusqu'à ce que **-> Settings** s'affiche.
- Appuyer sur la touche **START**. **SOUND / BELL = off/on** s'affiche.
- Choisir avec le bouton de réglage **○ off** (arrêt) ou **on** (marche).
- Appuyer sur la touche **START** pour sauvegarder le réglage.
Store Settings ... et ensuite **-> Settings** s'affichent brièvement à titre de confirmation.
- Appuyer 1 x sur la touche **OPEN / STOP** pour quitter le menu "Settings" ou appuyer 2 x sur la touche **OPEN / STOP** pour quitter le "menu Machine".

21 Données de centrifugation affichées après le démarrage

Les données de centrifugation du programme 1 ou du dernier programme utilisé s'affichent après le démarrage.

Cela peut être réglé de la manière suivante, lorsque le rotor est immobile :

- Maintenir la touche **PROG** enfoncée pendant 8 secondes.
Le ***** Machine Menu ***** s'affiche après 8 secondes.
- Appuyer sur la touche **PROG** jusqu'à ce que **-> Settings** s'affiche.
- Appuyer sur la touche **START**. **SOUND / BELL = off/on** s'affiche.
- Appuyer sur la touche **PROG** jusqu'à ce que s'affiche **Start program = Last/First**.
- Choisir avec le bouton de réglage **○ Last** ou **First**.
Last = dernier programme utilisé, First = programme 1.
- Appuyer sur la touche **START** pour sauvegarder le réglage.
Store Settings ... et ensuite **-> Settings** s'affichent brièvement à titre de confirmation.
- Appuyer 1 x sur la touche **OPEN / STOP** pour quitter le menu "Settings" ou appuyer 2 x sur la touche **OPEN / STOP** pour quitter le "menu Machine".

22 Régler l'unité de mesure de la température (uniquement pour une centrifugeuse avec un refroidissement)

La température peut être saisie en degré Celsius (°C) ou en degré Fahrenheit (°F).

Il faut pour cela régler l'unité de mesure de la température de la manière suivante, lorsque le rotor est immobile :

- Maintenir la touche **PROG** enfoncée pendant 8 secondes.
Le ***** Machine Menu ***** s'affiche après 8 secondes.
- Appuyer sur la touche **PROG** jusqu'à ce que **-> Settings** s'affiche.
- Appuyer sur la touche **START**. **SOUND / BELL = off/on** s'affiche.
- Appuyer sur la touche **PROG** jusqu'à ce que s'affiche **Temp Unit = Celsius/Fahrenheit**.
- Choisir avec le bouton de réglage **○ Celsius** ou **Fahrenheit**.
- Appuyer sur la touche **START** pour sauvegarder le réglage.
Store Settings ... et ensuite **-> Settings** s'affichent brièvement à titre de confirmation.
- Appuyer 1 x sur la touche **OPEN / STOP** pour quitter le menu "Settings" ou appuyer 2 x sur la touche **OPEN / STOP** pour quitter le "menu Machine".

23 Paramétrer verrouillage du programme

Lorsque le rotor est à l'arrêt, vous pouvez paramétrer les verrouillages des programmes suivants:

- LOCK 1** **LOCK 1** s'affiche dans le champ "⏏".
Vous pouvez appeler les programmes mais pas les modifier.
- LOCK 2** **LOCK 2** s'affiche dans le champ "⏏".
Vous ne pouvez ni appeler ni modifier de programmes.
Vous pouvez commander la centrifugeuse via l'interface (uniquement pour les centrifugeuses avec interface).
- LOCK 3** Aucun message affiché.
Pas de verrouillage du programme. Vous pouvez appeler et modifier les programmes.

- Maintenir la touche **ⓂPROG** enfoncée pendant 8 secondes.
Le ***** Machine Menu ***** s'affiche après 8 secondes.
- Appuyer sur la touche **ⓂPROG** jusqu'à ce que **-> Change LOCK** s'affiche.
- Appuyer sur la touche **ⓂSTART**. Le statut Lock s'affiche.
Si aucun code PIN n'est saisi, **LOCK = <3> confirm by START** s'affiche par exemple.
Si un code PIN est saisi, **LOCK = 3** s'affiche par exemple.
- Avec le bouton rotatif **Ⓜ**, réglez le statut Lock souhaité.



Si un code PIN est saisi, **PIN = ---- confirm by START** s'affiche. Dans ce cas, il faut d'abord régler le PIN valide avec le bouton rotatif **Ⓜ** puis appuyer la touche **ⓂSTART** avant de pouvoir régler le statut Lock.

- Appuyer sur la touche **ⓂSTART** pour sauvegarder le réglage.
Store LOCK 2 ... et ensuite **-> Change LOCK** s'affichent brièvement à titre de confirmation.
- Appuyer 1 x sur la touche **ⓂOPEN / STOP** pour quitter le menu "Change LOCK" ou appuyer 2 x sur la touche **ⓂOPEN / STOP** pour quitter le "menu Machine".

24 PIN (numéro d'identification personnel)

Pour empêcher la modification du verrouillage du programme par des personnes non autorisées, vous pouvez paramétrer un code PIN.



Aucun code PIN réglé au départ de l'usine.

24.1 Régler ou modifier code PIN

Lorsque le rotor est à l'arrêt, vous pouvez régler le code PIN en procédant comme suit :

- Maintenir la touche **PROG** enfoncée pendant 8 secondes.
Le ***** Machine Menu ***** s'affiche après 8 secondes.
- Appuyer sur la touche **PROG** jusqu'à ce que **-> Change PIN** s'affiche.
- Appuyer sur la touche **START** **old PIN = ---- <START>** s'affiche.
- Avec le bouton rotatif **○**, réglez le bon code PIN.



Lorsque vous réglez le code PIN pour la première fois, sautez cette étape ou réglez "0000".

Aide à la saisie :

Maintenez la touche correspondante appuyée.

↵ : seule la 1000ème position du PIN sera modifiée.

RCF : seule la 100ème position du PIN sera modifiée.

RPM : seule la 10ème position du PIN sera modifiée.

TIME : seule la 1ème position du PIN sera modifiée.

- Appuyer sur la touche **START** **new PIN = ---- <START>** s'affiche.



Si vous avez saisi un mauvais code PIN, **old PIN = ---- <START>** réapparaît sur l'afficheur. Dans ce cas, réglez le bon code PIN avec le bouton rotatif **○** puis appuyez la touche **START**.

- Avec le bouton rotatif **○**, réglez le nouveau code PIN.



Pour effacer le code PIN, réglez "0000".

- Appuyer sur la touche **START** pour sauvegarder le réglage.
Store PIN... et ensuite **-> Change PIN** s'affichent brièvement à titre de confirmation.
- Appuyer 1 x sur la touche **OPEN / STOP** pour quitter le menu "Change PIN" ou appuyer 2 x sur la touche **OPEN / STOP** pour quitter le "menu Machine".

24.2 Modifier code PIN oublié

Si vous avez oublié votre code PIN, vous pouvez faire appel à un "chiffre-aide". Ce chiffre permet au fabricant de calculer un code PIN avec lequel vous pourrez modifier le PIN oublié. En cas de besoin, adressez-vous à votre fournisseur.

- Maintenir la touche **PROG** enfoncée pendant 8 secondes.
Le ***** Machine Menu ***** s'affiche après 8 secondes.
- Appuyer sur la touche **PROG** jusqu'à ce que **-> Change PIN** s'affiche.
- Appuyer sur la touche **START** **old PIN = ---- <START>** s'affiche.
- Appuyer sur la touche **PROG** **Get HELP # no** s'affiche.
- Avec le bouton rotatif **○**, réglez **yes**.
- Appuyer sur la touche **START** **Are you sure ? no** s'affiche.
- Avec le bouton rotatif **○**, réglez **yes**.
- Appuyer sur la touche **START** Le chiffre d'aide s'affiche, par ex. **HELP # = 5487**.
- Notez ce chiffre d'aide et demandez le code PIN requis avec ce chiffre.
- A l'aide du PIN obtenu, réglez votre nouveau code PIN (voir chapitre "Régler ou modifier PIN").

25 Adresse de la centrifugeuse



L'adresse est réglée à l'usine sur] = 29e adresse.

26 Fonctions RCF-Integral et B-Ramp



Ces fonctions ne sont pas activées de manière standard.

27 Interrogation des heures de service et du nombre de cycles de centrifugation

Les heures de service sont divisées en heures de service internes et externes.

Heures de service internes : durée totale de marche de l'appareil.

Heures de service externes : durée totale des cycles de centrifugation effectués jusqu'à maintenant.

Les heures de service et le nombre de cycles de centrifugation peuvent être interrogés de la manière suivante, lorsque le rotor est immobile :

- Maintenir la touche **PROG** enfoncée pendant 8 secondes.
Le ***** Machine Menu ***** s'affiche après 8 secondes.
- Appuyer sur la touche **PROG** jusqu'à ce que -> **Operating Time** s'affiche.
- Appuyer sur la touche **START**. Les heures de service externes s'affichent, par ex. **OP Time ext = 0h25m**.
- Appuyer sur la touche **PROG**. Les heures de service internes s'affichent, par ex. **OP Time int = 1h36m**.
- Appuyer sur la touche **PROG**. Le nombre de cycles de centrifugation s'affiche, par ex. **Number of Starts = 10**.
- Appuyer 2 x sur la touche **OPEN/STOP** pour quitter le menu "Operating Time" ou appuyer 3 x sur la touche **OPEN/STOP** pour quitter le "menu Machine".

28 Interrogation des informations sur le système

Les informations sur le rotor et la version du programme de la centrifugeuse et du convertisseur de fréquence peuvent être interrogées de la manière suivante, lorsque le rotor est immobile :

- Maintenir la touche **PROG** enfoncée pendant 8 secondes.
Le ***** Machine Menu ***** s'affiche après 8 secondes.
- Appuyer sur la touche **PROG** jusqu'à ce que -> **Info** s'affiche.
- Appuyer sur la touche **START**. Le code du rotor (Rotor), la vitesse maximale de rotation du rotor (Nmax) et le rayon de centrifugation fixé à l'avance (R) du dernier rotor reconnu par l'identification du rotor s'affichent, par ex. **Rotor 4* : Nmax = 4500 R = 184**.
Le dernier rotor reconnu est marqué avec un astérisque (*). Il est maintenant possible d'afficher avec le bouton de réglage **○** les informations relatives aux rotors autorisés dans la centrifugeuse.
- Appuyer sur la touche **PROG**. La version du programme de la centrifugeuse s'affiche, par ex. **SW-Version = 01.00**.
- Appuyer sur la touche **PROG**. La version du programme du convertisseur de fréquence s'affiche, par ex. **FC-SW-Version = 4**.
- Appuyer 2 x sur la touche **OPEN/STOP** pour quitter le menu "Info" ou 3 x sur la touche **OPEN/STOP** pour quitter le "menu Machine".

29 Affichage immédiat des données de centrifugation après le démarrage

- Fermer l'interrupteur de secteur. (Position de l'interrupteur I).
- Lors de la première modification optique de l'affichage (affichage inversé), appuyer et maintenir enfoncée n'importe quelle touche. Les données de centrifugation s'affichent immédiatement.

30 Refroidissement (uniquement sur centrifugeuse avec refroidissement)

La température de consigne peut être réglée sur une plage de -20°C à +40°C / -4°F à +104°F. Pour les centrifugeuses équipées de l'option Chauffer/refroidir, la valeur prescrite de la température est réglable de -20°C à +90°C / -4°F à +194°F. Le minimum de température possible est fonction du rotor (voir le Chapitre "Anhang/Appendix, Rotoren und Zubehör/Rotors and accessories").

30.1 Refroidissement en veilleuse

Lorsque le rotor est immobile et que le couvercle est fermé, le compartiment centrifuge refroidit jusqu'à la température fixée à l'avance, lorsque celle-ci est inférieure à 20°C / 68°F.

La température fixée à l'avance est affichée pendant le refroidissement en "stand-by".

30.2 Pré-refroidissement du rotor



Pour pré-refroidir rapidement le rotor non chargé et les accessoires, il est recommandé de lancer un cycle de centrifugation en fonctionnement continu à une vitesse d'env. 20% de la vitesse de rotation maximum du rotor. Le pré-refroidissement est automatique avec le programme **PREC** (PRECOOLING). Un pré-refroidissement n'est pas possible lorsque vous travaillez avec des associations de programmes.

- Appuyer sur la touche . La DEL de la touche clignote jusqu'à ce que le rotor soit lu, la DEL clignote ensuite.
- Après l'expiration de la durée ou l'interruption du cycle de centrifugation en appuyant sur la touche , le ralentissement a lieu avec le niveau de freinage réglé. Le paramètre de ralentissement s'affiche, par ex. 9. La DEL droite de la touche s'allume. Après l'immobilisation du rotor, la DEL de la touche s'éteint et **OPEN** **OEFFNEN** s'affiche. La DEL droite de la touche s'éteint également, la DEL gauche de la touche commence à clignoter jusqu'à ce que le couvercle s'ouvre.

La vitesse de rotation du rotor ou la valeur RCF en résultant, la température des échantillons et le temps qui reste ou qui s'est écoulé s'affichent pendant le cycle de centrifugation.

31 Chauffage (uniquement sur centrifugeuse avec l'option Chauffer/refroidir)

Au cours du fonctionnement de centrifugation, en cas de besoin, la zone de centrifugation peut être chauffée à une température pré-sélectionnée.

Lorsque le rotor est au point mort, le chauffage est éteint.



Risque de brûlure ! La température de surface de l'élément chauffant dans le compartiment de centrifugation de la centrifugeuse peut monter jusqu'à 500 °C / 932 °F. Ne pas toucher l'élément chauffant.



Les balanciers à encoche en plastique doivent uniquement être utilisés avec des températures d'au maximum 40 °C / 104 °F.

32 Accélération centrifuge relative (RCF)

L'accélération centrifuge relative (RCF) est indiqué en tant que multiple de l'accélération gravitationnelle (g). Il s'agit d'une valeur dépourvue d'unité, qui sert à la comparaison entre la puissance de séparation et de sédimentation.

Le calcul s'effectue à l'aide de la formule suivante:

$$RCF = \left(\frac{RPM}{1000} \right)^2 \times r \times 1,118 \quad \Rightarrow \quad RPM = \sqrt{\frac{RCF}{r \times 1,118}} \times 1000$$

RCF = accélération centrifuge relative

RPM = régime

r = rayon de centrifugation en mm = distance qui sépare le centre de l'axe de rotation du fond de la cuve de centrifugation. Rayon de centrifugation voir chapitre "Anhang/Appendix, Rotoren und Zubehör/Rotors and accessories".



L'accélération centrifuge relative (RCF) est dépendante du régime et du rayon de centrifugation.

33 Centrifugation de matières et de mélanges d'une densité supérieure à 1,2 kg/dm³

Dans le cas de la centrifugation à la vitesse maximale, la densité des substances et des mélanges de substances ne doit pas excéder 1,2 kg/dm³. Réduire la vitesse de rotation pour les matières et mélanges ayant une densité supérieure.

La vitesse de rotation autorisée se calcule de la manière suivante:

$$\text{Vitesse de centrifugation lente (n}_{\text{red}}) = \sqrt{\frac{1,2}{\text{densité supérieure [kg/dm}^3]}} \times \text{Vitesse de rotation maximum [RPM]}$$

Exemple: Vitesse de rotation maximum RPM 4000, densité 1,6 kg/dm³

$$n_{\text{red}} = \sqrt{\frac{1,2 \text{ kg/dm}^3}{1,6 \text{ kg/dm}^3}} \times 4000 \text{ RPM} = 3464 \text{ RPM}$$

Dans le cas exceptionnel de dépassement de la charge maximum indiquée sur la suspension, réduire également la vitesse de rotation.

La vitesse de rotation autorisée se calcule de la manière suivante:

$$\text{Vitesse de centrifugation lente (n}_{\text{red}}) = \sqrt{\frac{\text{Charge maximum [g]}}{\text{Charge réelle [g]}}} \times \text{Vitesse de rotation maximum [RPM]}$$

Exemple: Vitesse de rotation maximum RPM 4000, Charge maximum 300 g, Charge réelle 350 g

$$n_{\text{red}} = \sqrt{\frac{300 \text{ g}}{350 \text{ g}}} \times 4000 \text{ RPM} = 3703 \text{ RPM}$$

En cas d'incertitude, prendre contact avec le fabricant.

34 Identification de rotor

Après démarrage de chaque cycle de centrifugation, la machine exécute une routine d'identification du rotor utilisé.

Après un changement de rotor, l'entraînement s'arrête et le code du rotor (Rotor), la vitesse maximale de rotation du rotor (Nmax) et le rayon de centrifugation fixé à l'avance (R) pour le rotor utilisé s'affichent, par ex. **Rotor 4 Nmax=4500 R=184 mm.**

- Appuyer sur la touche **OPEN/STOP** pour ouvrir le couvercle ou sur la touche **START** pour lancer le cycle de centrifugation. Dans le cas des centrifugeuses avec un refroidissement, il est également possible de démarrer le prérefroidissement du rotor en appuyant sur la touche **PRE**.



Suite à un changement de rotor, si la vitesse maximale de rotation du rotor est inférieure à la vitesse de rotation paramétrée, la vitesse de rotation est limitée à la vitesse maximale de rotation du rotor. Le numéro de position du programme s'affiche dans ce cas entre parenthèses ().

35 Déverrouillage d'urgence

En cas de panne de courant, le couvercle ne peut pas être déverrouillé avec le moteur. Il est nécessaire d'exécuter un déverrouillage manuel.



Avant d'exécuter le déverrouillage manuel, retirer la fiche de l'alimentation.
Attendre que le rotor est à l'arrêt pour ouvrir le couvercle.

Voir illustration sur la page 2.

- Couper l'interrupteur de secteur (position de l'interrupteur "0").
- Regarder par la fenêtre située sur le couvercle pour s'assurer que le rotor est immobile.
- Insérer horizontalement la clé mâle coudée à six pans creux dans l'orifice (Fig. 1, A) et tourner avec précaution d'un demi-tour dans le sens des aiguilles d'une montre jusqu'à ce que le couvercle puisse être ouvert.
- Retirer la clé à six pans hors de l'alésage.
- Si, après la remise sous tension de la centrifuge, la DEL gauche de la touche **OPEN/STOP** clignote, appuyer la touche **OPEN/STOP** pour que le verrouillage motorisé du couvercle revienne en position de base (ouvert).

36 Entretien et maintenance



Retirer la prise de secteur avant de nettoyer.

Avant d'utiliser une procédure de nettoyage ou de décontamination autre que celle recommandée par le fabricant, l'utilisateur vérifiera auprès du fabricant que la procédure prévue n'endommage pas l'appareil.

- Ne pas nettoyer centrifuges, rotors et accessoires dans un lave-vaisselle.
- Seul le nettoyage manuel et une désinfection liquide sont autorisés.
- La température de l'eau doit être située entre 20 et 25°C.
- Utiliser exclusivement des agents de nettoyage ou de désinfection qui :
 - ont un pH de 5 à 8,
 - ne contiennent pas de substances caustiques, de peroxyde, composés chlorés, acides ni alcalins.
- Respecter impérativement les consignes spéciales d'utilisation données par le fabricant des agents de nettoyage et de désinfection, afin de prévenir la corrosion par les agents de nettoyage et de désinfection.

36.1 Centrifugeuse (boîtier, couvercle et cuve)

36.1.1 Entretien et nettoyage des surfaces

- Nettoyer régulièrement le boîtier de la centrifugeuse et le compartiment de centrifugation et les laver en cas de besoin avec du savon ou un détergent doux et un chiffon humide. Ces opérations sont nécessaires pour garantir l'hygiène et pour prévenir la corrosion par la présence durable d'impuretés.
- Substances des nettoyeurs adéquats :
savon, agents anioniques et non ioniques.
- Après utilisation des nettoyeurs, enlevez les résidus en essuyant l'appareil avec un chiffon humide.
- Séchez immédiatement les surfaces après nettoyage.
- Sécher le bol avec un chiffon absorbant en cas de dépôt d'eau de condensation dans le bol de la centrifugeuse.
- Frotter légèrement le joint d'étanchéité en caoutchouc du compartiment de centrifugation, après chaque nettoyage, avec de la poudre de talc ou un produit d'entretien pour caoutchouc.
- Vérifiez tous les ans le bon état de la cuve.



N'utilisez plus la centrifugeuse si elle présente des dommages susceptibles de porter atteinte à la sécurité. Auquel cas, contactez le service après-vente.

36.1.2 Désinfection des surfaces

- Le bol de la centrifugeuse doit être nettoyé immédiatement dans le cas où un matériau infectieux a pénétré dans le bol de la centrifugeuse.
- Substances des désinfectants adéquats :
éthanol, n-propanol, isopropanol, glutardialdéhyde, combinaisons ammoniacales quaternaires.
- Après utilisation de désinfectants, enlevez les résidus en essuyant l'appareil avec un chiffon humide.
- Séchez immédiatement les surfaces après désinfection.

36.1.3 Décontamination de substances radioactives

- L'agent employé doit expressément convenir pour une décontamination de substances radioactives.
- Substances des agents adaptés à une décontamination des substances radioactives :
agents anioniques, non ioniques agents, éthanol polyhydrique.
- Après décontamination des substances radioactives, enlevez les résidus en essuyant l'appareil avec un chiffon humide.
- Séchez immédiatement les surfaces après décontamination des substances radioactives.

36.2 Rotors et accessoires

36.2.1 Nettoyage et entretien

- Afin de prévenir la corrosion et les modifications des matériaux, il faut laver régulièrement les rotors et les accessoires avec du savon ou un détergent doux et un chiffon humide. Il est vivement recommandé d'effectuer un nettoyage au moins une fois par semaine. Enlevez immédiatement les impuretés.
- Substances des nettoyants adéquats :
savon, agents anioniques et non ioniques.
- Après utilisation de nettoyants, enlevez les résidus en rinçant à l'eau claire (uniquement à l'extérieur de la centrifugeuse) ou en essuyant les surfaces avec un chiffon humide.
- Séchez rotors et accessoires immédiatement après nettoyage.
- Après séchage, les rotors d'angle, les réservoirs et la suspension en aluminium seront enduits d'une pellicule de graisse sans acide, par exemple la vaseline.
- Dans le cas des systèmes de sécurité biologique (Pour ce qui concerne les systèmes à sécurité biologique, voir le chapitre "Anhang/Appendix, Rotoren und Zubehör/Rotors and accessories") il faut contrôler et nettoyer les bagues d'étanchéité régulièrement (toutes les semaines). Changer immédiatement la bague d'étanchéité si elle présente des marques de fissuration, de friabilité et d'usure. Pour éviter de fausser la bague d'étanchéité en ouvrant et en fermant le couvercle, il faut frotter légèrement la bague d'étanchéité avec de la poudre de talc ou un produit d'entretien pour caoutchouc.
- Déposer le rotor au moins une fois par mois, nettoyer et enduire l'arbre d'entraînement d'une pellicule de graisse pour prévenir la corrosion par la présence d'humidité entre le rotor et l'arbre d'entraînement.
- Vérifier une fois par mois l'état d'usure et de corrosion des rotors et des accessoires. Pour les rotors à oscillation, vérifier surtout la zone de portée des tourillons et pour les balanciers, vérifier les rainures et le fond pour détecter les éventuelles fissures.



Les rotors et les accessoires usés et endommagés par la corrosion ne doivent plus être utilisés.

- Vérifier chaque semaine la stabilité de fixation du rotor.

36.2.2 Désinfection

- Si les rotors ou accessoires sont infectés, procédez à une désinfection appropriée.
- Substances des désinfectants adéquats :
glutaraldehyde, propanol, éthylènehexanol, agents anioniques, inhibiteurs de corrosion.
- Après utilisation de désinfectants, enlevez les résidus en rinçant à l'eau claire (uniquement à l'extérieur de la centrifugeuse) ou en essuyant les surfaces avec un chiffon humide.
- Séchez rotors et accessoires immédiatement après désinfection.

36.2.3 Décontamination de substances radioactives

- L'agent employé doit expressément convenir pour une décontamination de substances radioactives.
- Substances des agents adaptés à une décontamination des substances radioactives :
agents anioniques, agents non ioniques, éthanol polyhydre.
- Après décontamination des substances radioactives, enlevez les résidus en rinçant à l'eau claire (uniquement à l'extérieur de la centrifugeuse) ou en essuyant les surfaces avec un chiffon humide.
- Séchez immédiatement rotors et accessoire après décontamination des substances radioactives.

36.2.4 Goupilles de fixation

Les goupilles de fixation des rotors à amortissement doivent être graissées régulièrement (graisse de lubrification Hettich n° 4051) de manière à assurer le balancement régulier de la suspension.

36.2.5 Rotors et accessoires à durée d'utilisation limitée

L'utilisation de certains rotors, balanciers et accessoires est limitée dans le temps.

Ces limites sont indiquées par le nombre maximum de cycles ou la date limite d'utilisation et le nombre maximum de cycles, ou simplement la date limite d'utilisation, par ex. :

- "einsetzbar bis Ende: IV. Quartal 2011 / usable until end of: IV. trimestre 2011" (utilisation autorisée jusqu'à fin: IV. trimestre 2011) ou
"einsetzbar bis Ende Monat/Jahr: 10/2011 / usable until end of month/year: 10/2011" (utilisation autorisée jusqu'à fin mois/an : 10/2011)
- "max. Laufzyklen / max. cycles: 40000" (nombre ma. de cycles 40000)



Pour des raisons de sécurité, l'utilisation de rotors, balanciers et accessoires n'est plus autorisée dès que le nombre maximum de cycles désigné ou la date limite d'utilisation inscrite sont atteints.

Vous pouvez demander le nombre de cycles de centrifugation effectués, voir chapitre "Demande des heures de fonctionnement et du nombre de cycles de centrifugation".

36.3 Autoclavage

Les rotors à oscillation, les rotors angulaires en aluminium, les balanciers en métal, les couvercles avec un joint d'étanchéité biologique, ainsi que les châssis et les réducteurs peuvent être autoclavés à 121 °C / 250 °F (20 min).

En cas de doute, il faut se renseigner auprès du fabricant.

Le degré de stérilité ne peut pas être indiqué.



Avant l'autoclavage, déposer le couvercle des rotors et du récipient.

L'autoclavage provoque l'accélération du vieillissement des plastiques et peut provoquer des décolorations des plastiques.

Nous recommandons le remplacement des bagues d'étanchéité de bio systèmes de sécurité après autoclave.

36.4 Réservoirs de centrifugation

- En cas de fuite ou de rupture de récipients de centrifugation, il faut éliminer tous les morceaux de récipients cassés, les fragments de verre et les substances centrifugées écoulées.
- Les amortisseurs antivibrations ainsi que les caoutchouc intermédiaires des rotors doivent être remplacés après un bris de verre.



Les fragments de verre restants peuvent entraîner d'autres bris de verre !

- S'il s'agit d'un matériau infectieux, exécuter immédiatement une désinfection.

37 Défaits

Si l'erreur ne peut pas être éliminée d'après le tableau des défauts, il faut alors avertir le service après-vente.

Veillez indiquer le type de centrifuge et le numéro de série. Les deux numéros sont indiqués sur la plaque signalétique de la centrifugeuse.



Effectuer une RÉINITIALISATION DU SECTEUR :

- Couper l'interrupteur de secteur (position de l'interrupteur "0").
- Attendre au moins 10 secondes et refermer ensuite l'interrupteur de secteur (position de l'interrupteur "I").

Message / Erreur		Origine	Solution
Pas de message		Pas de tension Déclenchement du fusible protecteur contre surintensité. Déclenchement du coupe-circuit automatique (seulement pour les types 1701-01 et 1706-01).	<ul style="list-style-type: none"> - Contrôler la tension d'alimentation - Remettre en service le coupe-circuit automatique, voir au chapitre "Mettre le coupe-circuit automatique en service" (seulement pour les types 1701-01 et 1706-01). - Secteur en marche
TACHO - ERROR	1, 2, 96	Tachymètre défectueux. Défaut de l'électronique du moteur.	<ul style="list-style-type: none"> - Ouvrir le couvercle. - Couper l'interrupteur de secteur (position de l'interrupteur "0"). - Attendre au moins 10 secondes. - Tourner vigoureusement le rotor à la main. - Refermer l'interrupteur de secteur (position de l'interrupteur "I"). Le rotor doit fonctionner pendant la mise en marche.
IMBALANCE		Le rotor est chargé de manière non symétrique.	<ul style="list-style-type: none"> - Ouvrir le capot. - Vérifier le chargement du rotor, voir au chapitre "Chargement du rotor". - Répéter le cycle de centrifugation.
CONTROL - ERROR	4.1 - 4.5, 6	Erreur du verrouillage ou de la fermeture du capot.	<ul style="list-style-type: none"> - Effectuer une RÉINITIALISATION DU SECTEUR.
N > MAX	5	Survitesse	
N < MIN	13	Vitesse trop basse	
ROTORCODE	10.1, 10.3	Erreur codage du rotor	
MAINS INTERRUPT		Interruption du secteur pendant le cycle de centrifugation. (Le cycle de centrifugation n'est pas terminé.)	<ul style="list-style-type: none"> - Ouvrir le capot. - Appuyer sur la touche START. - En cas de besoin, répéter le cycle de centrifugation.
VERSION-ERROR	12	Pas de correspondance entre les composants électroniques. Défaut / Panne de l'électronique.	<ul style="list-style-type: none"> - Effectuer une RÉINITIALISATION DU SECTEUR.
CONTROL-ERROR	22, 25.1 - 25.4	Défaut / Panne de l'électronique.	
SER I/O - ERROR	31 - 34, 36	Défaut / Panne de l'électronique.	
° C * - ERROR	51, 53 - 55, 97, 98	Défaut / Panne de l'électronique.	
° C * - ERROR	52	Surtempérature dans le compartiment centrifuge. Défaut / Panne de l'électronique.	
FU / CCI - ERROR	60, 61.2-61.20, 61.128-61.131, 62	Défaut / Panne de l'électronique / du moteur.	
FU / CCI - ERROR	61.1	Tension du secteur trop faible. Défaut / Panne de l'électronique / du moteur.	
			<ul style="list-style-type: none"> - Vérifier la tension du secteur. - Effectuer une RÉINITIALISATION DU SECTEUR.

Message / Erreur		Origine	Solution
SENSOR-ERROR	90	Défaut / Panne de l'électronique.	- Effectuer une RÉINITIALISATION DU SECTEUR.
SENSOR-ERROR	91 - 93	Défaut / Panne de détecteur anti-balourd	
NO ROTOR OR ROTORCODE ERROR		Pas de rotor intégré. Tachymètre défectueux.	- Ouvrir le capot. - Monter rotor.
WRONG ROTOR !!!		(uniquement pour type 1701-30) Un rotor non autorisé pour le type 1701-30 est installé.	- Ouvrir le capot. - Monter le rotor 1798.
N > ROTOR MAX		Vitesse de rotation paramétrée dans le programme sélectionné supérieure à la vitesse maximale de rotation du rotor.	- Corriger la vitesse du programme sélectionnée
N > ROTOR MAX in Prog : par ex. 3		L'emplacement de programme affiché contient un programme dont la vitesse de rotation est supérieure à la vitesse maximum du rotor.	
Runtime 00:00 in Prog : par ex. 3		L'emplacement de programme affiché contient un programme en fonctionnement continu.	- Dans l'association de programmes, remplacer le programme en fonctionnement continu par un programme à présélection temps.
Empty Program		L'emplacement de programme affiché ne contient pas d'association de programmes.	- Appeler une association de programmes.
FC INIT ERROR		Défaut / Panne de l'électronique	- Effectuer une RÉINITIALISATION DU SECTEUR.
FC VERSION ERROR		Défaut / Panne de l'électronique	
FATAL EEPROM ERROR	1 - 5	Défaut / Panne de l'électronique	

38 Mettre le coupe-circuit automatique en service (seulement pour les types 1701-01 et 1706-01)



Amener le commutateur principal en position d'arrêt et détacher la centrifugeuse du secteur !

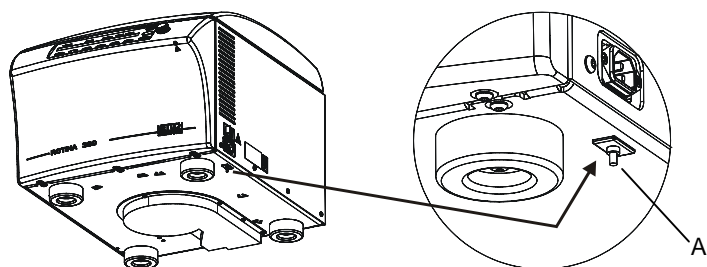

- Appuyer sur la tige en plastique (A) du coupe-circuit automatique.
- Rétablir le raccord de la centrifugeuse au secteur.

39 Réparation des centrifugeuses

Dans le cas où la centrifugeuse est expédiée au fabricant pour réparation, elle doit être décontaminée et nettoyée avant expédition, dans le but d'assurer la protection des personnes, de l'environnement et du matériel.

Nous nous réservons le droit de refuser les centrifugeuses contaminées.

Nous facturons au client les frais de nettoyage et de désinfection.

Vous voudrez bien manifester votre compréhension pour cette réglementation.

40 Élimination des déchets

Avant de mettre l'appareil au rebut, vous devez le décontaminer et le nettoyer pour la protection des personnes, de l'environnement et du matériel.

Les dispositions légales en vigueur doivent être respectées lors de l'élimination de l'appareil.

Conformément à la directive 2002/96/CE (WEEE), tous les appareils livrés après le 13.08.2005 ne doivent plus être jetés avec les déchets ménagers. L'appareil fait partie du groupe 8 (dispositifs médicaux) et est classé dans le domaine "Business-to-Business".



Le symbole de la poubelle barrée d'une croix indique que l'appareil ne doit pas être jeté avec les déchets ménagers.

Les dispositions relatives à l'élimination des déchets des différents pays de l'UE peuvent varier. Veuillez-vous adresser en cas de besoin à votre fournisseur.

Indice

1	Usò previsto.....	84
2	Rischi residui	84
3	Dati tecnici	84
4	Indicazioni inerenti la sicurezza	85
5	Significato dei simboli	86
6	Contenuto della fornitura	87
7	Disimballo della centrifuga.....	87
8	Messa in funzione.....	87
9	Interfaccia (solo per la centrifuga con interfaccia).....	87
10	Apertura e chiusura del coperchio.....	88
10.1	Apertura del coperchio.....	88
10.2	Chiusura del coperchio	88
11	Installazione e disinstallazione del rotore	88
12	Carico del rotore.....	89
13	Chiudere i rotori ad angolo a tenuta ermetica in modo da impedire la fuoriuscita di aerosol.....	89
14	Elementi di operazione e visualizzazione.....	89
14.1	Manopola	89
14.2	Pulsanti e possibilità di regolazione	90
15	Immissione dei parametri di centrifugazione	91
15.1	Tempo ciclo.....	91
15.2	Numero di giri (RPM)	91
15.3	Accelerazione centrifuga relativa (RCF) e raggio di centrifugazione (RAD).....	91
15.3.1	Raggio di centrifugazione (RAD)	91
15.3.2	Accelerazione centrifuga relativa (RCF)	91
15.4	Parametri di avviamento e di arresto	92
15.4.1	Livello di avviamento	92
15.4.2	Livello di frenatura	92
15.4.3	Velocità di rotazione di disinserimento frenatura	92
15.5	Temperatura (soltanto per centrifuga con refrigerazione)	92
16	Programmazione	92
16.1	Programmi preimpostati.....	92
16.2	Immettere o modificare i dati.....	93
16.3	Richiamare i programmi	93
16.4	Protezione da scrittura per programmi.....	93
16.5	Concatenamento di programmi.....	93
16.5.1	Attivare o disattivare concatenamento programmi.....	93
16.5.2	Concatenare programmi o modificare un concatenamento di programmi.....	94
16.5.3	Richiamare la concatenazione di programmi	94
16.6	Memoria temporanea automatica	94
17	Centrifugazione	95
17.1	Centrifugazione con preselezione del tempo	95
17.2	Funzionamento continuo.....	95
17.3	Centrifugazione a impulsi.....	96

18	Modifica delle impostazioni durante il ciclo di centrifugazione.....	96
19	Arresto d'emergenza	96
20	Segnale acustico	96
21	Dati di centrifugazione visualizzati dopo l'accensione	97
22	Impostazione dell'unità della temperatura (soltanto per centrifuga con refrigerazione)	97
23	Impostare bloccaggi di programma	97
24	PIN (Numero personale di identificazione)	98
24.1	Impostare o modificare il PIN	98
24.2	Modificare il PIN dimenticato.....	98
25	Indirizzo della centrifuga.....	98
26	Funzioni RCF-Integral e B-Ramp	98
27	Consultazione delle ore di funzionamento e del numero di cicli di centrifugazione	99
28	Consultazione delle informazioni di sistema	99
29	Visualizzazione immediata dei dati di centrifugazione dopo l'accensione	99
30	Raffreddamento (solo per centrifuga con raffreddamento).....	99
30.1	Raffreddamento-Standby	99
30.2	Preraffreddamento del rotore	100
31	Riscaldamento (solo per centrifughe con opzione di riscaldamento/ raffreddamento)	100
32	Accelerazione centrifuga relativa (RCF).....	100
33	Centrifugazione di sostanze o di miscele di sostanze con densità maggiore di 1,2 kg/dm ³	101
34	Riconoscimento del rotore.....	101
35	Sblocco di emergenza	101
36	Pulizia e manutenzione	102
36.1	Centrifughe (scatola, coperchio e vano di centrifugazione).....	102
36.1.1	Cura e pulizia delle superfici	102
36.1.2	Disinfezione delle superfici	102
36.1.3	Rimuovere contaminazioni radioattive	102
36.2	Rotori ed accessori	103
36.2.1	Pulizia e cura	103
36.2.2	Disinfezione	103
36.2.3	Rimuovere contaminazioni radioattive	103
36.2.4	Perni di trascinamento	103
36.2.5	Rotori ed accessori con limitata durata di impiego.....	104
36.3	Mantenere in autoclave.....	104
36.4	Contenitori centrifuga	104
37	Guasti	105
38	Inserire l'interruttore automatico	106
39	Accettazione di centrifughe da riparare	107
40	Smaltimento	107
41	Anhang / Appendix	108
41.1	Rotoren und Zubehör / Rotors and accessories.....	108
41.1.1	ROTINA 380 / 380 R, Typen / types 1701, 1701-01, 1706, 1706-01	108
41.1.2	ROTINA 380, Typ / type 1701-30.....	131

1 Uso previsto

La presente macchina è un articolo medicale (centrifuga di laboratorio) ai sensi delle direttive IVD 98/79/CE. La centrifuga separa sostanze e/o miscele di sostanze con una densità max. di 1,2 kg/dm³. Sono comprese anche sostanze e miscele di origine umana. La centrifuga deve essere utilizzata unicamente per questo scopo. Qualsiasi altro tipo di utilizzo è improprio. La ditta Andreas Hettich GmbH & Co. KG non risponde dei danni che ne conseguono.

L'uso previsto comporta anche il rispetto di tutte le avvertenze delle istruzioni d'uso e l'esecuzione dei lavori di ispezione e manutenzione stabiliti.

2 Rischi residui

La macchina è costruita secondo lo stato della tecnica e le regole tecniche di sicurezze riconosciute. L'utilizzo o il trattamento non conformi possono causare pericoli per la vita e la salute dell'operatore o di terzi e anche danni materiali e alla macchina. La macchina deve essere impiegata solo l'uso previsto e solo in perfetto stato di sicurezza.

Eliminare immediatamente i guasti che possono compromettere la sicurezza.

3 Dati tecnici

Costruttore	Andreas Hettich GmbH & Co. KG D-78532 Tuttlingen				
Modello	ROTINA 380			ROTINA 380 R	
Tipo	1701-30	1701	1701-01	1706, 1706-50	1706-01
Tensione di rete ($\pm 10\%$)	200-240 V 1~ / 100-127 V 1~	200-240 V 1~	100-127 V 1~	200-240 V 1~	110-127V 1~
Frequenza di rete	50 – 60 Hz	50 – 60 Hz	50 – 60 Hz	50 – 60 Hz	60 Hz
Potenza assorbita	massimo 450 VA	650 VA	700 VA	1300 VA	1400 VA
Assorbimento di corrente		3.3 A	7.0 A	6.5 A	13.0 A
Tipo di refrigerante	----			R 404A	
Capacità max.	4 x 290 ml				
Densità permessa	1.2 kg/dm ³				
Regime di rotazione (RPM)	4000	15000			
Accelerazione (RCF)	3095	24400			
Energia cinetica	6200 Nm	18500 Nm		35000 Nm	
Obbligo di collaudo (BGR 500)	no	si			
Presupposti ambientali (EN / IEC 61010-1)	solo in interni fino a 2000 metri sopra il livello del mare 2°C fino a 35°C 5°C fino a 35°C umidità relativa massima dell'aria 80% per temperature fino a 31°C, con riduzione lineare fino al 50% dell'umidità relativa per una temperatura di 40°C.				
– luogo di installazione					
– altezza					
– temperatura ambiente					
– umidità dell'aria					
– Categoria di sovratensione (IEC 60364-4-443)	II				
– grado di imbrattamento	2				
Classe di protezione	I				
non adatto per l'impiego in ambiente a rischio di esplosione.					
Compatibilità elettromagnetica					
– emissione di radiointerferenze, resistenza alle interferenze	EN / IEC 61326-1, classe B; FCC Class B	EN / IEC 61326-1, classe B	FCC Class B	EN / IEC 61326-1, classe B	FCC Class B
Livello di emissione acustica (in funzione del rotore)	≤ 58 dB(A)	≤ 65 dB(A)		≤ 64 dB(A) ¹⁾	
dimensioni					
– larghezza	457 mm			457 mm	
– profondità	600 mm			750 mm	
– altezza	418 mm			418 mm	
Peso	ca. 58.5 kg	ca. 51 kg	ca. 58.5 kg	ca. 81 kg	ca. 88.5 kg

1) con rotore 1797 ≤ 70 dB(A)

4 Indicazioni inerenti la sicurezza



Se non vengono rispettate tutte le avvertenze riportate in queste istruzioni per il funzionamento, non può essere accettata da parte del costruttore alcuna richiesta di garanzia.



- La centrifuga deve venire posizionata in modo sicuro.
- Prima di utilizzare la centrifuga, è necessario controllare che il rotore sia correttamente in sede.
- Durante un'operazione di centrifugazione, in una zona di sicurezza di 300 mm attorno alla centrifuga non deve sostare alcuna persona, materiali pericolosi ed oggetti, in conformità alle norme EN / IEC 61010-2-020.
- I rotori, le sospensioni e gli accessori che presentano forti segni di corrosione o danni meccanici, oppure la cui durata d'impiego è scaduta, non devono più essere utilizzati.
- Se il vano di centrifugazione presenta danni rilevanti per la sicurezza, la centrifuga non deve essere più messa in funzione.
- In rotori oscillanti, i perni di trascinamento devono essere lubrificati regolarmente (Grasso lubrificante Hettich no. d'ord. 4051) per consentire un'oscillazione equilibrata dei ganci.

- Prima di mettere in funzione la centrifuga si devono leggere ed osservare le istruzioni per l'uso. L'apparecchio può essere utilizzato solo da persone che abbiano letto e compreso le istruzioni d'uso.
- Oltre alle istruzioni per l'uso, si devono osservare anche i regolamenti, relativi alla protezione antinfortunistica ed i regolamenti tecnici, riconosciuti in materia di sicurezza del lavoro. Le istruzioni per l'uso vanno completate dalle norme nazionali in vigore nel paese d'impiego, relative alla protezione antinfortunistica ed alla tutela ambientale.
- La centrifuga è costruita in base all'attuale livello tecnologico e le regole di sicurezza conosciute. La centrifuga può essere tuttavia fonte di pericolo per l'operatore o per terzi, se non viene utilizzata da personale appositamente addestrato o se viene utilizzata in modo improprio o non conforme alla destinazione.
- Durante l'esercizio bisogna evitare di muovere la centrifuga o di urtarvi contro.
- In caso di guasto, ovvero del ripristino d'emergenza, non si deve assolutamente toccare il rotore.
- Quando la centrifuga passa da un ambiente freddo in uno caldo, per evitare danni dovuti alla condensa, lasciar riscaldare la centrifuga per almeno 3 ore nell'ambiente caldo prima di collegarla alla rete, oppure portare la centrifuga a temperatura d'esercizio mettendola in funzione per 30 minuti nell'ambiente freddo.
- Devono essere utilizzati esclusivamente i rotori e gli accessori omologati per questa apparecchiatura (vedere capitolo "Anhang/Appendix, Rotoren und Zubehör/Rotors and accessories").
- Il rotore della centrifuga può essere caricato solo in conformità al capitolo " Carico del rotore".
- In caso di centrifugazione con massimo numero di giri, la densità dei materiali o delle miscele di materiali non deve superare il valore di composizione di 1,2 kg/dm³.
- Non è consentito l'uso di centrifughe non bilanciate in modo regolamentare.
- Non è permesso l'impiego della centrifuga in ambiente a pericolo di esplosione.
- E' proibito l'uso di una centrifuga con:
 - materiali infiammabili od esplosivi
 - materiali che possono reagire chimicamente tra loro con forte energia.
- Se vengono centrifugate sostanze pericolose o miscele di sostanze contaminate da micro organismi tossici, radioattivi o patogeni, l'utente dovrà prendere opportuni provvedimenti in materia. Si devono fondamentalmente utilizzare contenitori per centrifugazione con tappi a vite speciali per sostanze pericolose. Con materiali dei gruppi di rischio 3 e 4, oltre ai contenitori per centrifugazione chiudibili si deve impiegare un sistema di sicurezza biologico (vedi manuale "Laboratory Biosafety Manual" dell'Organizzazione mondiale per la salute).
In un sistema di sicurezza biologico una guarnizione biologica (anello di guarnizione) impedisce la fuoriuscita delle goccioline e degli aerosol.
Se la sospensione di un sistema di sicurezza biologico viene usata senza coperchio, la guarnizione ad anello deve essere rimossa dalla sospensione per evitare di danneggiarla durante il ciclo di centrifugazione. Le guarnizioni ad anello danneggiate non possono più essere utilizzate per la chiusura a tenuta del sistema di sicurezza biologico.

Senza l'impiego di un sistema di sicurezza biologico, una centrifuga non è microbiologicamente a tenuta in conformità alla norma EN / IEC 61010-2-020.

Per quanto riguarda i sistemi biologici di sicurezza fornibili, rimandiamo al capitolo "Anhang/Appendix, Rotoren und Zubehör/Rotors and accessories". Nel dubbio chiedere maggiori informazioni al produttore o importatore.

- Non è consentito il funzionamento della centrifuga con sostanze altamente corrosive che possono pregiudicare la resistenza meccanica dei rotori, delle sospensioni e degli accessori.
- Gli interventi di riparazione devono essere effettuati esclusivamente da una persona autorizzata dal costruttore.
- Devono essere impiegati solo ed esclusivamente pezzi di ricambio originali ed accessori autorizzati della ditta Andreas Hettich GmbH & Co. KG.
- Sono di validità le seguenti norme di sicurezza:
EN / IEC 61010-1 e EN / IEC 61010-2-020 come anche le loro nazionali varianti.
- La sicurezza e l'affidabilità della centrifuga sono garantite solo se:
 - la centrifuga funziona in conformità con le istruzioni per l'uso
 - l'installazione elettrica sul luogo di posizionamento della centrifuga risponde ai requisiti previsti dalla EN / IEC
 - i controlli previsti in base a BGV A1, BGR 500 vengono eseguiti da un perito esperto in materia.

5 Significato dei simboli



Simbolo nella macchina:

Attenzione, punto pericoloso generico.

Prima di utilizzare la centrifuga, è assolutamente necessario leggere le istruzioni d'uso e rispettare le avvertenze relative alla sicurezza!



Simbolo in questo documento.

Attenzione, punto pericoloso generico.

Questo simbolo contraddistingue le avvertenze relative alla sicurezza e indica situazioni potenzialmente pericolose .

La mancata osservanza di tali avvertenze può causare danni materiali e personali.



Simbolo nella macchina e in questo documento:

Attenzione alle superfici molto calde.

Il mancato rispetto di questa avvertenza può portare a danneggiamenti alle cose e alle persone.



Simbolo nella macchina e in questo documento:

Le sospensioni di plastica possono essere utilizzate solamente a temperature fino a massimo 40° C / 104° F.

Il mancato rispetto di questa avvertenza può portare a danneggiamenti alle cose e alle persone.



Simbolo nella macchina:

Equipotenziale: connettore a spina (connettore PA) per collegamento equipotenziale (solo nelle centrifughe con connettore PA).



Simbolo nella macchina:

Interfaccia RS232 (solo per la centrifuga con interfaccia RS232).



Simbolo nella macchina:

Interruttore automatico (solo per tipi 1701-01 e 1706-01).



Simbolo in questo documento:

Questo simbolo indica argomenti importanti.



Simbolo nella macchina e in questo documento:

Simbolo per la raccolta separata delle apparecchiature elettriche ed elettroniche, in conformità alle direttive 2002/96/CEE (WEEE). L'apparecchiatura appartiene al gruppo 8 (apparecchiature medicali).

Impiego nelle nazioni dell'Unione Europea, in Norvegia ed in Svizzera.

6 Contenuto della fornitura

- 1 cavo elettrico
- 1 chiave a forcina 5 mm
- 1 grasso per perni portanti
- 1 istruzioni per l'uso
- 1 istruzioni per la sicurezza durante il trasporto
- 1 CD (solo per il tipo 1701-30)

Rotore/i e i corrispondenti accessori vengono forniti in base alla commessa.

7 Disimballo della centrifuga

- Levare il cartone verso l'alto e togliere l'imbottitura.



Non sollevarla dalla copertura anteriore.
Considerare il peso della centrifuga, vedere capitolo "Dati tecnici".

Con il numero adeguato di persone, sollevare la centrifuga da entrambi i lati e riporla sul tavolo di laboratorio.

8 Messa in funzione

- Secondo la norma sugli strumenti di laboratorio EN / IEC 61010-2-020 gli impianti domestici devono essere provvisti di apposito sezionatore d'emergenza per l'interruzione della rete in caso di guasto. L'interruttore deve essere posizionato distante dalla centrifuga, preferibilmente al di fuori della stanza in cui è posizionata la centrifuga o vicino all'uscita.
- **Porre la centrifuga in un posto adatto e livellarla. Per l'installazione deve essere rispettata la zona di sicurezza di 300 mm attorno alla centrifuga, richiesta in conformità alle norme EN / IEC 61010-2-020.**



Durante un'operazione di centrifugazione, in una zona di sicurezza di 300 mm attorno alla centrifuga non deve sostare alcuna persona, materiali pericolosi ed oggetti, in conformità alle norme EN / IEC 61010-2-020.

- Non posizionare alcun oggetto in prossimità delle griglie di ventilazione. Mantenere un'area di ventilazione di 300 mm, intorno al condotto.
- Centrifuga con connettore PA:
all'occorrenza collegare il connettore PA sul retro dell'apparecchio con un sistema di collegamento equipotenziale medico aggiuntivo.
- Centrifuga con interfaccia RS232:
collegare l'interfaccia RS232 della centrifuga al PC con un cavo di collegamento RS232 (non fa parte della fornitura).
- Verificare se la tensione di rete sia adatta all'indicazione riportata nella targhetta con i dati caratteristici.
- Collegare la centrifuga ad una spina standard di rete tramite il cavo di collegamento. Per la potenza massima assorbita, vedere il capitolo "Dati tecnici".
- Inserire l'interruttore di rete (posizione interruttore "I"). I LED presenti nei pulsanti lampeggiano. I dati seguenti vengono visualizzati in successione:
 1. il modello della centrifuga
 2. la versione del programma
 3. il codice del rotore (Rotor), la velocità di rotazione massima del rotore (Nmax) e il raggio di centrifugazione preimpostato (R) dell'ultimo rotore riconosciuto tramite l'apposito sistema di riconoscimento.
 4. **OPEN / OEFFNEN**
- Aprire il coperchio.
Vengono illustrati i dati di centrifuga del programma utilizzato per ultimo o del programma 1.
- Rimuovere la protezione per il trasporto, vedi le istruzioni per la sicurezza durante il trasporto".

9 Interfaccia (solo per la centrifuga con interfaccia)

In opzione, l'apparecchiatura può essere dotata di un'interfaccia RS232.

L'interfaccia RS232 è contrassegnata dal simbolo 

Attraverso questa interfaccia si può comandare la centrifuga e richiamare i dati.

Il LED del tasto  s'illumina durante la comunicazione dei dati.

10 Apertura e chiusura del coperchio

10.1 Apertura del coperchio



E' possibile aprire il coperchio solo se la centrifuga è accesa ed il rotore è fermo.
Se non dovesse essere possibile, vedi capitolo "Sblocco di emergenza".

- Premere il tasto **OPEN/STOP**. Il coperchio si sblocca a motore e il LED sinistro nel tasto **OPEN/STOP** si spegne.

10.2 Chiusura del coperchio



Non afferrare con le dita tra il coperchio e il rivestimento.
Non chiudere il coperchio sbattendolo.

Quando lampeggia il LED di sinistra nel tasto **OPEN/STOP**, premere il tasto **OPEN/STOP**, in modo che il bloccaggio motorico del coperchio prenda la posizione di base (aperto).

- Posizionare il coperchio e spingere leggermente verso il basso il bordo anteriore del coperchio. La chiusura avviene grazie ad un sistema motorizzato. Si illumina il LED sinistro del tasto **OPEN/STOP**.

11 Installazione e disinstallazione del rotore

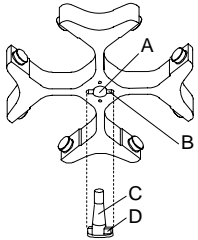

- Pulire l'albero motore (C) ed il foro del rotore (A), successivamente lubrificare leggermente l'albero motore. Particelle di sporco tra l'albero motore ed il rotore impediscono un normale funzionamento del rotore e causano un movimento rumoroso.
- Porre il rotore in senso verticale sull'albero motore. Il meccanismo di trascinamento dell'albero motore (D) deve trovarsi nella scanalatura del rotore (B). Sul rotore è segnato l'allineamento della scanalatura.
- Stringere il dado di registrazione di tensione del rotore con l'aiuto della chiave inclusa nel cartone, ruotandola in senso orario.
- Verificare che il rotore sia fissato.
- Disinstallare il rotore: svitare il dado di registrazione di tensione, ruotandolo in senso anti-orario fino a che non abbia raggiunto il punto di completo svitamento. Con il punto di svitamento completo, il rotore si può smontare dal cono dell'albero motore. Girare il dado di registrazione di tensione fino a che diventi possibile smontare il rotore dall'albero motore.

12 Carico del rotore



Lo standard dei recipienti di vetro centrifugati sono da caricare fino a RCF 4000 (DIN 58970 capoverso 2).

- Verificare che il rotore sia fissato.
Nel caso di rotori oscillanti, tutti i siti del rotore devono essere muniti di ganci **uguali**. Particolari ganci sono contrassegnati con il numero del sito del rotore. Questi ganci devono essere applicati solo nel relativo sito del rotore.
Ganci contrassegnati con un numero di kit, p.es. S001/4, devono essere utilizzati esclusivamente in kit.
- I rotori ed i ganci devono essere caricati esclusivamente in modo simmetrico. I recipienti di centrifuga devono essere distribuiti uniformemente su tutti i posti del rotore. Per le combinazioni permesse vedere capitolo "Anhang/Appendix, Rotoren und Zubehör/Rotors and accessories".
In caso di rotori angolari devono essere caricati tutti i possibili siti del rotore, vedere il capitolo "Anhang/Appendix, Rotoren und Zubehör/Rotors and accessories".

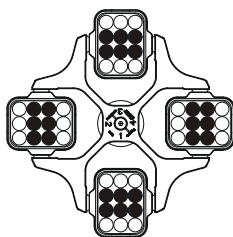

Il rotore è caricato uniformemente

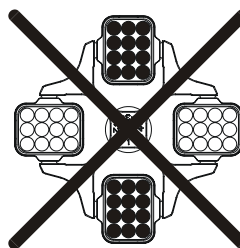

Non ammesso!

Il rotore è caricato in modo non uniforme

- Su certe sospensioni è indicato il peso del carico massimo oppure il peso del carico massimo e il peso massimo della sospensione completamente equipaggiata. Questi pesi non devono essere superati. In casi eccezionali vedere al capitolo "Centrifugazione di sostanze o di miscele di sostanze con densità maggiore di 1,2 kg/dm³". Il peso indicato per il carico massimo comprende il peso completo di riduttore, supporto, provetta da centrifuga e contenuto.
- Nel caso di contenitori con inserimenti in gomma, deve essere sempre mantenuto lo stesso numero di inserimenti in gomma sotto i contenitori di centrifugazione.
- Riempire i recipienti della centrifuga all'esterno della centrifuga stessa.
- Fare attenzione che non giunga alcuna sostanza liquida nella camera di centrifugazione durante il carico ed l'oscillazione dei ganci.
- Il carico massimo dei recipienti della centrifuga non deve essere superiore a quello indicato dalla casa costruttrice.
- Per limitare al massimo le differenze di peso all'interno dei contenitori di centrifugazione, bisogna fare attenzione che siano riempiti tutti in modo uguale.

13 Chiudere i rotori ad angolo a tenuta ermetica in modo da impedire la fuoriuscita di aerosol

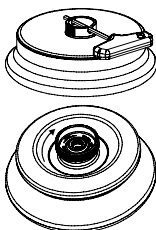

Per garantire la tenuta agli aerosol, il coperchio di un rotore angolare a tenuta di aerosol deve essere ben chiuso.

Ciò è possibile con l'ausilio della chiave in dotazione, che viene inserita attraverso il foro della manopola. Se nella manopola non è presente alcun foro, il coperchio deve essere chiuso manualmente, ruotandolo in senso orario.

Per i rotori ad angolo anti-aerosol disponibili, vedi capitolo "Anhang/Appendix, Rotoren und Zubehör/Rotors and accessories".

14 Elementi di operazione e visualizzazione

Vedere illustrazione alla pagina 2

Fig. 2, Fig. 3: Display

14.1 Manopola



Per l'impostazione dei singoli parametri.

La rotazione in senso antiorario riduce il valore. La rotazione in senso orario aumenta il valore.

14.2 Pulsanti e possibilità di regolazione

-  • Tempo ciclo, parametro **t/hms**.
h: ore. Regolabile da 1 a 99 ore, in intervalli di 1 ora.
m: minuti. Regolabile da 1 a 59 minuti, in intervalli di 1 minuto.
s: secondi. Regolabile da 1 a 59 secondi, in intervalli di 1 secondo.



 - Funzionamento continuo "∞"

-  • Velocità di rotazione, parametro **RPM**.
Regolabile da 50 RPM fino alla velocità massima di rotazione del rotore (Nmax), in intervalli di 10. Per la velocità massima di rotazione del rotore, vedere capitolo "Appendice/Appendix, Rotori e accessori/Rotors and accessories".

-  • Accelerazione centrifuga relativa, parametro **RCF**.
L' RCF viene mostrato in parentesi) (. Il LED nel tasto è luminoso.
E' possibile regolare un valore numerico che dà come risultato una velocità di rotazione tra 50 RPM e la velocità massima di rotazione del rotore (Nmax). Regolabile in intervalli di 1.

 - Raggio di centrifugazione, parametro **RAD**.
Regolabile da 85 mm a 330 mm, in intervalli di 1 millimetro. Per il raggio di centrifugazione, vedere capitolo "Appendice/Appendix, Rotori e accessori/Rotors and accessories".

-  Parametri di avviamento e di arresto

 - Livelli di avviamento, parametro .
Livello 9 = tempo di avviamento più breve, ... livello 1 = tempo di avviamento più lungo.
 - Livelli di frenatura, parametro .
Livello 9 = tempo di arresto più breve, ... livello 1 = tempo di arresto lungo, livello 0 = arresto non frenato.
 - Velocità di rotazione di disinserimento frenatura, parametro **N Brake**.
Regolabile da 50 RPM fino alla velocità massima di rotazione del rotore (Nmax), in intervalli di 10.
Una volta raggiunta questa velocità di rotazione avviene l'arresto non frenato.

-  • Temperatura (soltanto per centrifuga con refrigerazione)
Regolabile in gradi Celsius (°C) oppure in gradi Fahrenheit (°F). Impostazione dell'unità della temperatura, vedere il capitolo "Impostazione dell'unità della temperatura".
Parametro **T/°C** = gradi Celsius (°C).
Regolabile da -20° C a +40° C, in intervalli di 1° C (con l'opzione Riscaldamento/ Refrigerazione regolabile da -20° C a +90° C).
Parametro **T/°F** = gradi Fahrenheit (°F).
Regolabile da -4° F a +104° F, in intervalli di 1° F (con l'opzione Riscaldamento/ Refrigerazione regolabile da -4° F a +194° F).
La temperatura più bassa raggiungibile dipende dal rotore (vedere il capitolo "Appendice/Appendix, Rotori e accessori/Rotors and accessories").

-  • Richiamare i programmi ed i concatenamenti di programmi, parametro **RCL**.
Programmi: Posti di programma 1 fino a 99 e PREC. concatenamenti di programmi: Posti di programma A fino a Z..

 - Memorizzare i programmi ed i concatenamenti di programmi, parametro **STO**.
Si possono salvare 99 programmi (per centrifuga senza refrigerazione: posizioni di programma da 1 a 99, per centrifuga con refrigerazione: posizioni di programma da 1 a 98 e PREC). La posizione di programma PREC (PRECOOLING) è riservata per il programma di prerrefrigerazione. La posizione di programma 0 funge da memoria temporanea per i dati dell'ultimo ciclo di centrifugazione eseguito. In questa posizione non è possibile salvare nessun programma.
Possono venire memorizzati 25 concatenamenti di programmi (posti di programma A fino a Z, posto di programma J non esiste). Un concatenamento di programmi può essere costituito da 20 programmi.
 - Concatenare i programmi, parametro **EDIT**.
 - Richiamare il "Machine Menu" (tenere premuto il pulsante per 8 secondi) e selezionare i parametri in questo menu.

-  • Avviare la prerrefrigerazione del rotore (soltanto per centrifuga con refrigerazione). Durante il ciclo di centrifugazione il LED presente nel pulsante rimane illuminato fino a che il rotore gira.
La prerrefrigerazione del rotore avviene automaticamente con il programma **PREC** (PRECOOLING).

-  • Avvio del ciclo di centrifugazione. Durante il ciclo di centrifugazione il LED presente nel pulsante rimane illuminato fino a che il rotore gira.

 - Centrifugazione a impulsi.
Il ciclo di centrifugazione ha luogo finché si tiene premuto il pulsante . Durante il ciclo di centrifugazione il LED presente nel pulsante rimane illuminato fino a che il rotore gira.
 - Salvare le immissioni e le modifiche.



- Terminare il ciclo di centrifuga.
Il rotore si arresta gradualmente con il parametro di arresto prestabilito. Il LED destro del tasto rimane acceso fintanto che il rotore non si arresta. Dopo l'arresto del rotore si illumina il LED sinistro del tasto. Premendo due volte il tasto si inserisce l'arresto d'emergenza.
- Sbloccare il coperchio.
Si spegne il LED sinistro del tasto.
- Uscire dall'impostazione parametri e dal "Machine Menu".

15 Immissione dei parametri di centrifugazione



Nel caso in cui, dopo aver selezionato oppure durante l'inserimento di parametri, non venga premuto per 8 secondi alcun tasto, vengono indicati i valori precedenti. L'inserimento dei parametri deve essere poi eseguita nuovamente.

Quando si immettono più parametri, il pulsante **START** deve essere premuto solamente dopo aver impostato l'ultimo parametro.

Se si modificano i parametri, il numero della posizione di programma viene visualizzato tra parentesi (). Questo significa che i dati di centrifugazione mostrati sul display non corrispondono più ai dati di centrifugazione salvati della posizione di programma.

L'immissione dei parametri può essere interrotta in qualsiasi momento premendo il pulsante **OPEN/STOP**. In questo caso le impostazioni non vengono salvate.

15.1 Tempo ciclo



Per impostare il funzionamento continuo si devono azzerare i minuti, i secondi e le ore. Il funzionamento continuo è indicato sul display dal simbolo "∞".

- Premere il pulsante **TIME**. È visualizzato il parametro **t/hms**. I minuti (**m**) sono mostrati tra parentesi **< >** e possono essere modificati.
- Impostare il valore desiderato utilizzando la manopola **○**.
- Premere il pulsante **TIME**. I secondi (**s**) sono mostrati tra parentesi **< >** e possono essere modificati.
- Impostare il valore desiderato utilizzando la manopola **○**.
- Premere il pulsante **TIME**. Le ore (**h**) sono mostrate tra parentesi **< >** e possono essere modificate.
- Impostare il valore desiderato utilizzando la manopola **○**.
- Premere il pulsante **START** per accettare l'impostazione visualizzata sul display.

15.2 Numero di giri (RPM)

- Premere il pulsante **RPM**. È visualizzato il parametro **RPM**.
- Impostare il valore desiderato utilizzando la manopola **○**.
- Premere il pulsante **START** per accettare l'impostazione visualizzata sul display.

15.3 Accelerazione centrifuga relativa (RCF) e raggio di centrifugazione (RAD)

15.3.1 Raggio di centrifugazione (RAD)

- Premere il tasto **RCF** così a lungo, finché vengono visualizzati i parametri **RAD** e **RCF**, per es. **RAD = 146 -> RCF = 3695**. Il LED presente nel pulsante s'illumina.
- Impostare il raggio di centrifugazione desiderato utilizzando la manopola **○**.
Quando si modifica il raggio di centrifugazione il valore RCF cambia automaticamente in modo corrispondente.
- Premere il pulsante **START** per accettare l'impostazione visualizzata sul display.

15.3.2 Accelerazione centrifuga relativa (RCF)







La relativa accelerazione centrifugale (RCF) dipende dal raggio di centrifugazione. Prima di impostare la RCF deve essere impostato il raggio di centrifugazione, si veda il capitolo "Raggio di centrifugazione (RAD)".





- Premere il tasto **RCF** così a lungo, finché vengono visualizzati i parametri **RCF** e **RAD**, per es. **RCF = 3695 RAD = 146**. Il LED presente nel pulsante s'illumina.
- Impostare il valore RCF desiderato utilizzando la manopola **○**.
- Premere il pulsante **START** per accettare l'impostazione visualizzata sul display.

15.4 Parametri di avviamento e di arresto



15.4.1 Livello di avviamento

- Premere il pulsante  il numero di volte necessario per visualizzare il parametro .
- Impostare il livello desiderato utilizzando la manopola .
- Premere il pulsante  per accettare l'impostazione visualizzata sul display.

15.4.2 Livello di frenatura



- Premere il pulsante  il numero di volte necessario per visualizzare il parametro .
- Impostare il livello desiderato utilizzando la manopola .
- Premere il pulsante  per accettare l'impostazione visualizzata sul display.

15.4.3 Velocità di rotazione di disinserimento frenatura

- Premere il pulsante  il numero di volte necessario per visualizzare il parametro **N Brake**.
- Impostare il valore desiderato utilizzando la manopola .
- Premere il pulsante  per accettare l'impostazione visualizzata sul display.

15.5 Temperatura (soltanto per centrifuga con refrigerazione)

 La temperatura può essere immessa in gradi Celsius (°C) oppure in gradi Fahrenheit (°F). Impostazione dell'unità della temperatura, vedere il capitolo "Impostazione dell'unità della temperatura".









- Premere il pulsante . È visualizzato il parametro **T/°C** o **T/°F**.
- Impostare il valore desiderato utilizzando la manopola .
- Premere il pulsante  per accettare l'impostazione visualizzata sul display.

16 Programmazione

 Se si modificano i parametri, il numero della posizione di programma viene visualizzato tra parentesi (). Questo significa che i dati di centrifugazione mostrati sul display non corrispondono più ai dati di centrifugazione salvati della posizione di programma.

16.1 Programmi preimpostati (solo per il tipo 1701-30)

 I programmi 1 fino a 4 sono preimpostati e protetti da scrittura. Al tentativo di memorizzare dati su posti di programma 1 fino a 4, viene esposto "**Protected !!**" ed i dati non vengono memorizzati. Con il richiamo del programma, per i posti di programma 1 fino a 4 viene esposto tramite "+", che questi dati sono protetti da scrittura. Se la protezione da scrittura viene eliminata, i dati dei posti di programma 1 fino a 4 possono venire modificati e memorizzati. La memorizzazione avviene però solo in modo temporaneo e dopo il disinserimento dell'apparecchiatura i dati modificati vanno persi di nuovo.

PROG 1	PROG 2	PROG 3	PROG 4
RAD 155	RAD 155	RAD 155	RAD 155
RCF 200	RCF 800	RCF 600	RCF 600
RPM 1074	RPM 2149	RPM 1861	RPM 1861
Tempo ciclo 2:15	Tempo ciclo 10:15	Tempo ciclo 10:15	Tempo ciclo 5:15
 9	 9	 9	 9
 0	 6	 6	 6

16.2 Immettere o modificare i dati

- Impostare i parametri desiderati (vedere il capitolo "Immissione dei parametri di centrifugazione").
- Premere il pulsante **PROG** il numero di volte necessario per visualizzare il parametro **STO**.
- Impostare la posizione di programma desiderata utilizzando la manopola **○**.



Se dietro il posto di programma viene esposto un "+", i dati sono protetti dalla scrittura. In questo caso prima di poter eseguire la memorizzazione deve essere tolta la protezione da scrittura (vedere capitolo "Protezione da scrittura per programmi").

- Premere il pulsante **START** per salvare le impostazioni nella posizione di programma desiderata. Come conferma viene visualizzato brevemente il messaggio **Program store ...**



Con la memorizzazione, i dati precedenti del posto di programma vengono sovrascritti.

Se viene esposto "**Protected !!**", i dati sul posto di programma sono protetti da scrittura e la memorizzazione non viene eseguita.

16.3 Richiamare i programmi

- Premere il pulsante **PROG**. È visualizzato il parametro **RCL**.
- Impostare la posizione di programma desiderata utilizzando la manopola **○**.



Se dietro il posto di programma viene esposto un "+", i dati sono protetti dalla scrittura.

- Premere il pulsante **START**. Come conferma viene visualizzato brevemente il messaggio **Program recall ...**. Sono visualizzati i dati di centrifugazione della posizione di programma scelta.

16.4 Protezione da scrittura per programmi

I programmi possono venire protetti contro una loro modifica non autorizzata.

La protezione da scrittura può essere attivata o disattivata, durante l'arresto del rotore, come segue:

- Richiamare il programma desiderato (vedere il capitolo "Richiamare programmi").
- Premere il pulsante **PROG**. È visualizzato il parametro **RCL**.
- Tenere premuto il tasto **PROG** 8 secondi.
Dopo 8 secondi compare p.es. **Set Protection = 1-** sul display.
- Impostare con la manopola **○** "+" o "-".
+ = Programma è protetto da scrittura,
- = Programma non è protetto da scrittura.
- Premere il tasto **START** per memorizzare l'impostazione.

16.5 Concatenamento di programmi

Con l'aiuto del concatenamento di programmi possono venire concatenati tra loro più svolgimenti di centrifugazione.



Un concatenamento di programmi è possibile solo quando questo è attivato (parametro **Multi programs = on**; vedere capitolo "Attivare o disattivare concatenamento programmi").

16.5.1 Attivare o disattivare concatenamento programmi

Il concatenamento di programmi può essere attivato o disattivato, durante l'arresto del rotore, come segue:

- Tenere premuto il pulsante **PROG** per 8 secondi.
Dopo 8 secondi sul display appare ***** Machine Menu *****.
- Premere il pulsante **PROG** fino a che non viene visualizzato **-> Settings**.
- Premere il pulsante **START**. Viene visualizzato **SOUND / BELL = off/on**.
- Premere il pulsante **PROG** fino a che non viene visualizzato **Multi programs = off/on**.
- Impostare con la manopola **○** **off** oppure **on**.
off = concatenazione di programma disattivata,
on = concatenazione di programma attivata.
- Premere il pulsante **START** per salvare l'impostazione.
Come conferma viene visualizzato brevemente il messaggio **Store Settings ...** e successivamente **-> Settings**.
- Premere 1 volta il pulsante **OPEN / STOP** per uscire dal menu "Settings", oppure premere 2 volte il pulsante **OPEN / STOP** per uscire dal menu "Machine Menu".

16.5.2 Concatenare programmi o modificare un concatenamento di programmi



Possono venire memorizzati 25 concatenamenti di programmi (posti di programma A fino a Z, posto di programma J non esiste). Un concatenamento di programmi può essere costituito al massimo da 20 programmi.

In un concatenamento di programmi, l'adeguamento del regime di rotazione da un programma all'altro avviene sempre con il parametro di avvio del programma successivo.

In un concatenamento di programmi non si deve trovare alcun programma di funzionamento continuo.

In un concatenamento di programmi non è ammesso modificare alcun parametro di centrifugazione. Una modifica dei parametri è possibile solo in singoli programmi.

Con il tasto **TIME** può essere richiamato durante lo svolgimento della centrifugazione il tempo complessivo di funzionamento del concatenamento di programmi (p.es. $\Sigma=00:05:30$) ed il tempo di funzionamento del programma attualmente in svolgimento (p.es. **t B.02=00:01:00**).

1. Premere più volte il tasto **PROG** fino a quando viene esposto il parametro **EDIT A...Z**.
2. Impostare con la manopola \odot il posto di programma desiderato, sul quale deve venire memorizzato il concatenamento di programmi.
3. Premere il tasto **START**. Viene esposto il posto di programma del concatenamento di programmi ed il primo programma del concatenamento di programmi, p.es. **EDIT B.01 = 01**.
4. Impostare con la manopola \odot il primo programma del concatenamento di programmi.
5. Premere il tasto **PROG**. Viene esposto il prossimo programma della concatenazione di programmi, p.es. **EDIT B.02 = END**.
6. Impostare con la manopola \odot il prossimo programma del concatenamento di programmi.
7. Premere il tasto **PROG**. Viene esposto il prossimo programma della concatenazione di programmi, p.es. **EDIT B.03 = END**.
8. Ripetere i passi 6 e 7 fino a quando tutti i programmi sono impostati.
9. Impostare con la manopola \odot **END** (girare la manopola in senso antiorario).



Con concatenamenti che sono costituiti da 20 programmi, dopo il 20° programma non può venire impostato alcun **END**.

10. Premere il tasto **START**. Viene esposto p.es. **STO B**.
11. Premere il tasto **START** per memorizzare il concatenamento di programmi.
Come conferma viene esposto brevemente **Multi program store ..**

16.5.3 Richiamare la concatenazione di programmi

- Premere più volte il tasto **PROG** fino a quando viene esposto il parametro **RCL A...Z**.
- Impostare la posizione di programma desiderata utilizzando la manopola \odot .
- Premere il pulsante **START**. Come conferma viene visualizzato brevemente il messaggio **Multi program recall**

...

Vengono esposti i dati di centrifugazione del primo programma della correlazione di programmi.

16.6 Memoria temporanea automatica

La posizione di programma 0 funge da memoria temporanea per i dati dell'ultimo ciclo di centrifugazione svolto.

In questa posizione non è possibile salvare nessun programma.

Ogni volta che si avvia un ciclo di centrifugazione, nella posizione di programma "0" vengono salvati automaticamente i dati di centrifugazione utilizzati per il funzionamento ed è possibile richiamarli.

17 Centrifugazione



Durante un'operazione di centrifugazione, in una zona di sicurezza di 300 mm attorno alla centrifuga non deve sostare alcuna persona, materiali pericolosi ed oggetti, in conformità alle norme EN / IEC 61010-2-020.



Nel caso in cui la differenza di peso permessa nel caricamento del rotore venga superata, si ferma l'azionamento durante l'avvio, e compare la dicitura **IMBALANCE**.

Se il numero di giri nel programma selezionato è più elevato del numero di giri massimo del rotore (Nmax), non è possibile avviare un ciclo di centrifugazione. Viene visualizzato **N > ROTOR MAX** (vedi capitolo "Guasti").

Se con concatenazioni di programma viene esposto **N > ROTOR MAX in Prog** : p.es. **5, Runtime 00:00 in Prog** : p.es. **5 o Empty Program**, non può essere avviato alcuno svolgimento di centrifugazione (vedi capitolo "Guasti").

Una corsa di centrifugazione può essere interrotta in ogni momento premendo il tasto **OPEN/STOP**.

Durante la corsa di centrifugazione, può essere selezionato e modificato ogni tipo di parametro (vedi capitolo "Immissione dei parametri di centrifugazione").

Con i tasti **RPM** e **RCF** è possibile passare in ogni momento dalla visualizzazione RPM a quella RCF e viceversa. Una commutazione non è possibile quando il lavoro avviene con concatenamenti di programmi. Se si lavora con la visualizzazione RCF, è necessario immettere il raggio di centrifugazione.

Se compaiono le diciture **OPEN OEFFNEN (=APRIRE)**, è possibile un'operazione della centrifuga solo dopo aver aperto una volta il coperchio.

Se il rotore è stato sostituito, il ciclo di centrifugazione non viene svolto ed appare per esempio il seguente messaggio **Rotore 4 Nmax= 4500 R=184 mm** (vedere il capitolo "Riconoscimento del rotore").

Gli errori operativi e le anomalie vengono esposti (vedi capitolo "Guasti").

- Accendere l'interruttore di rete. Posizione dell'interruttore I.
- Caricare il rotore e chiudere il coperchio della centrifuga.

17.1 Centrifugazione con preselezione del tempo

- Impostare un tempo di funzionamento, un programma con preselezione del tempo o un concatenamento di programmi (vedi capitolo "Immissione dei parametri di centrifugazione", "Richiamare i programmi" o "Concatenazione programmi").
- Premere il pulsante **START**. Il LED presente nel pulsante **START** lampeggia fino a che il rotore non viene letto, poi il LED si illumina con luce fissa.
- Allo scadere del tempo o in caso di interruzione del ciclo di centrifugazione premendo il pulsante **OPEN/STOP**, viene eseguito l'arresto con il relativo parametro selezionato. Il parametro di arresto viene visualizzato, per esempio **9**. Il LED destro presente nel pulsante **OPEN/STOP** si illumina. Una volta che il rotore si è fermato, il LED presente nel pulsante **START** si spegne e viene visualizzato **OPEN OEFFNEN (APRIRE)**. Si spegne anche il LED destro presente nel pulsante **OPEN/STOP**, il LED sinistro nel pulsante **OPEN/STOP** inizia a lampeggiare e continua a farlo fino a che non si apre il coperchio.

Durante il ciclo di centrifugazione vengono visualizzati il numero di giri del rotore o il valore RCF che ne risulta, la temperatura campione (solo nelle centrifughe con raffreddamento) ed il tempo residuo.

17.2 Funzionamento continuo

- Impostare su "0" i minuti, i secondi e le ore, oppure richiamare un programma di funzionamento continuo (vedere il capitolo "Immissione dei parametri di centrifugazione" oppure "Richiamare i programmi").
- Premere il pulsante **START**. Il LED presente nel pulsante **START** lampeggia fino a che il rotore non viene letto, poi il LED si illumina con luce fissa. Il conteggio del tempo inizia da 00:00.
- Premere il pulsante **OPEN/STOP** per terminare il ciclo di centrifugazione. L'arresto viene eseguito con il parametro di arresto scelto. Il parametro di arresto viene visualizzato, per esempio **9**. Il LED destro presente nel pulsante **OPEN/STOP** si illumina. Una volta che il rotore si è fermato, il LED presente nel pulsante **START** si spegne e viene visualizzato **OPEN OEFFNEN (APRIRE)**. Si spegne anche il LED destro presente nel pulsante **OPEN/STOP**, il LED sinistro nel pulsante **OPEN/STOP** inizia a lampeggiare e continua a farlo fino a che non si apre il coperchio.

Durante il ciclo di centrifugazione vengono visualizzati il numero di giri del rotore o il valore RCF che ne risulta, la temperatura campione (solo nelle centrifughe con raffreddamento) ed il tempo trascorso.

17.3 Centrifugazione a impulsi



Una centrifugazione di breve tempo non è possibile quando il lavoro avviene con concatenamenti di programmi.

- Tenere premuto il pulsante **START**. Il LED presente nel pulsante **START** lampeggia fino a che il rotore non viene letto, poi il LED si illumina con luce fissa. Il conteggio del tempo inizia da 00:00.
- Rilasciare il pulsante **START** per terminare il ciclo di centrifugazione. L'arresto viene eseguito con il parametro di arresto scelto. Il parametro di arresto viene visualizzato, per esempio ~ 9 . Il LED destro presente nel pulsante **OPEN/STOP** si illumina. Una volta che il rotore si è fermato, il LED presente nel pulsante **START** si spegne e viene visualizzato **OPEN** **OFFNEN** (APRIRE). Si spegne anche il LED destro presente nel pulsante **OPEN/STOP**, il LED sinistro nel pulsante **OPEN/STOP** inizia a lampeggiare e continua a farlo fino a che non si apre il coperchio.

Durante il ciclo di centrifugazione vengono visualizzati il numero di giri del rotore o il valore RCF che ne risulta, la temperatura campione (solo nelle centrifughe con raffreddamento) ed il tempo trascorso.

18 Modifica delle impostazioni durante il ciclo di centrifugazione



Non è possibile modificare impostazioni durante lo svolgimento della centrifugazione di breve tempo, se il lavoro avviene con concatenamenti di programmi.

Il tempo ciclo, il numero di giri, l'accelerazione centrifuga relativa (RCF), raggio di centrifugazione, i parametri di avviamento e di arresto nonché la temperatura (solo nelle centrifughe con raffreddamento) possono essere modificate durante il ciclo di centrifugazione.

- Scegliere il parametro desiderato e con la manopola \odot modificare il relativo valore (vedere il capitolo "Immissione dei parametri di centrifugazione").
- Premere il pulsante **START**. L'impostazione modificata viene salvata nella posizione di programma "0" (vedere il capitolo "Memoria temporanea automatica"). Il numero della posizione di programma viene visualizzato tra parentesi (). Il programma originale non viene sovrascritto.

19 Arresto d'emergenza

- Premere 2x il tasto **OPEN/STOP**.

Un eventuale arresto di emergenza viene eseguito con il livello di frenatura 9 (il tempo di arresto più breve). Viene visualizzato il livello di frenatura ~ 9 . Se era prelezionato il livello di frenatura 0, allora l'arresto viene eseguito con il livello di frenatura $\sim 9d$. Con il livello di frenatura 9d il tempo di arresto è più lungo, a causa di limitazioni tecniche, di quello che si ha con il livello di frenatura 9.

20 Segnale acustico

Il segnale acustico si attiva quando:

- con il verificarsi di un guasto con intervallo di 2 sec
- dopo il terminare della corsa di centrifugazione e arresto del rotore con intervallo di 30 secondi

Aperto il coperchio oppure premendo un tasto qualsiasi, il segnale acustico cessa.









Il segnale che si attiva in seguito alla cessazione della corsa di centrifugazione, può essere attivato o disattivato, raggiunto l'arresto del rotore, in modo seguente:

- Tenere premuto il pulsante **PROG** per 8 secondi.
Dopo 8 secondi sul display appare ***** Machine Menu *****.
- Premere il pulsante **PROG** fino a che non viene visualizzato -> **Settings**.
- Premere il pulsante **START**. Viene visualizzato **SOUND / BELL = off/on**.
- Con la manopola impostare \odot **off** (spento) oppure **on** (acceso).
- Premere il pulsante **START** per salvare l'impostazione.
Come conferma viene visualizzato brevemente il messaggio **Store Settings ...** e successivamente -> **Settings**.
- Premere 1 volta il pulsante **OPEN/STOP** per uscire dal menu "Settings", oppure premere 2 volte il pulsante **OPEN/STOP** per uscire dal menu "Machine Menu".

21 Dati di centrifugazione visualizzati dopo l'accensione

Dopo l'accensione sono visualizzati i dati di centrifugazione del programma 1, oppure quelli dell'ultimo programma utilizzato.



A rotore fermo questo può essere impostato nel modo seguente:

- Tenere premuto il pulsante  per 8 secondi.
Dopo 8 secondi sul display appare ***** Machine Menu *****.
- Premere il pulsante  fino a che non viene visualizzato **-> Settings**.
- Premere il pulsante . Viene visualizzato **SOUND / BELL = off/on**.
- Premere il pulsante  fino a che non viene visualizzato **Start program = Last/First**.
- Con la manopola impostare  **Last** oppure **First**.
Last = ultimo programma utilizzato, First = programma 1.
- Premere il pulsante  per salvare l'impostazione.
Come conferma viene visualizzato brevemente il messaggio **Store Settings ...** e successivamente **-> Settings**.
- Premere 1 volta il pulsante  per uscire dal menu "Settings", oppure premere 2 volte il pulsante  per uscire dal menu "Machine Menu".

22 Impostazione dell'unità della temperatura (soltanto per centrifuga con refrigerazione)



La temperatura può essere immessa in gradi Celsius (°C) oppure in gradi Fahrenheit (°F).





A tale scopo occorre impostare l'unità della temperatura, a rotore fermo, nel modo seguente:

- Tenere premuto il pulsante  per 8 secondi.
Dopo 8 secondi sul display appare ***** Machine Menu *****.
- Premere il pulsante  fino a che non viene visualizzato **-> Settings**.
- Premere il pulsante . Viene visualizzato **SOUND / BELL = off/on**.
- Premere il pulsante  fino a che non viene visualizzato **Temp Unit = Celsius/Fahrenheit**.
- Con la manopola impostare  **Celsius** oppure **Fahrenheit**.
- Premere il pulsante  per salvare l'impostazione.
Come conferma viene visualizzato brevemente il messaggio **Store Settings ...** e successivamente **-> Settings**.
- Premere 1 volta il pulsante  per uscire dal menu "Settings", oppure premere 2 volte il pulsante  per uscire dal menu "Machine Menu".



23 Impostare bloccaggi di programma



Durante l'arresto del rotore possono essere impostati i bloccaggi di programma:

- LOCK 1** **LOCK 1** viene esposto nel campo "".
I programmi possono venire richiamati, ma non possono venire modificati.
- LOCK 2** **LOCK 2** viene esposto nel campo "".
Non può essere richiamato e modificato alcun programma.
La centrifuga può essere comandata attraverso l'interfaccia (solo con centrifuga con interfaccia).
- LOCK 3** nessuna indicazione di stato.
Nessun bloccaggio di programma. I programmi possono venire richiamati e modificati.

- Tenere premuto il pulsante  per 8 secondi.
Dopo 8 secondi sul display appare ***** Machine Menu *****.
- Premere il pulsante  fino a che non viene visualizzato **-> Change LOCK**.
- Premere il pulsante . Viene esposto lo stato di Lock.
Se non è immesso alcun PIN, viene esposto p.es. **LOCK = (3) confirm by START**.
Se è immesso un PIN, viene esposto p.es. **LOCK = 3**.
- Impostare lo stato Lock desiderato tramite la manopola .



Se è immesso un PIN, viene esposto **PIN = ---- confirm by START**. In questo caso deve essere impostato dapprima il PIN valido con la manopola , per poi premere il tasto , prima di poter impostare lo stato Lock.

- Premere il pulsante  per salvare l'impostazione.
Come conferma viene visualizzato brevemente il messaggio **Store LOCK 2 ...** e successivamente **-> Change LOCK**.
- Premere 1 volta il pulsante  per uscire dal menu "Change LOCK", oppure premere 2 volte il pulsante  per uscire dal menu "Machine Menu".

24 PIN (Numero personale di identificazione)

Per impedire la modifica del bloccaggio di programma da parte di persone non autorizzate, può venire impostato un PIN.

 Di fabbrica non è impostato alcun PIN.

24.1 Impostare o modificare il PIN

Il PIN può essere impostato, durante l'arresto del rotore, come segue:

- Tenere premuto il pulsante **[PROG]** per 8 secondi.
Dopo 8 secondi sul display appare ***** Machine Menu *****.
- Premere il pulsante **[PROG]** fino a che non viene visualizzato **-> Change PIN**.
- Premere il pulsante **[START]**. Viene esposto **old PIN = ---- <START>**.
- Impostare con la manopola **[O]** il PIN valido.

 Se il PIN viene impostato per la prima volta, saltare questo passo o impostare "0000".

Aiuto per l'immissione:

Tenere premuto il rispettivo tasto.

[1000] : viene modificata solo la 1000. posizione del PIN.

[RCF] : viene modificata solo la 100. posizione del PIN.

[RPM] : viene modificata solo la 10. posizione del PIN.

[TIME] : viene modificata solo la 1. posizione del PIN.

- Premere il pulsante **[START]**. Viene esposto **new PIN = ---- <START>**.

 Se è stato impostato un PIN sbagliato, viene esposto di nuovo **old PIN = ---- <START>**. In questo caso impostare con la manopola **[O]** il PIN valido, e premere poi il tasto **[START]**.

- Impostare con la manopola **[O]** il nuovo PIN.

 Per cancellare il PIN deve venire impostato "0000".

- Premere il pulsante **[START]** per salvare l'impostazione.
Come conferma viene visualizzato brevemente il messaggio **Store PIN ...** e successivamente **-> Change PIN**.
- Premere 1 volta il pulsante **[OPEN/STOP]** per uscire dal menu "Change PIN", oppure premere 2 volte il pulsante **[OPEN/STOP]** per uscire dal menu "Machine Menu".

24.2 Modificare il PIN dimenticato

Se il PIN è stato dimenticato, può essere richiamato una cosiddetta cifra di soccorso (Help). Con l'aiuto di questa cifra il costruttore può calcolare un PIN, con il quale il PIN dimenticato può essere modificato. In caso di necessità rivolgetevi al vostro fornitore.

- Tenere premuto il pulsante **[PROG]** per 8 secondi.
Dopo 8 secondi sul display appare ***** Machine Menu *****.
- Premere il pulsante **[PROG]** fino a che non viene visualizzato **-> Change PIN**.
- Premere il pulsante **[START]**. Viene esposto **old PIN = ---- <START>**.
- Premere il pulsante **[PROG]**. Viene esposto **Get HELP # no**.
- Impostare con la manopola **[O]** **yes**.
- Premere il pulsante **[START]**. Viene esposto **Are you sure ? no**.
- Impostare con la manopola **[O]** **yes**.
- Premere il pulsante **[START]**. Viene esposta la cifra di soccorso (Help), p.es. **HELP # = 5487**.
- Annotare questa cifra di soccorso e richiedere con questa il PIN necessario.
- Con l'aiuto del PIN ricevuto impostare un nuovo PIN (vedere il capitolo "Impostare o modificare PIN").

25 Indirizzo della centrifuga

 Dalla fabbrica è stato impostato l'indirizzo] = 29.

26 Funzioni RCF-Integral e B-Ramp

 Come impostazione standard queste funzioni non sono attivate.

27 Consultazione delle ore di funzionamento e del numero di cicli di centrifugazione

Le ore di funzionamento sono suddivise in ore di funzionamento interne ed esterne.

Ore di funzionamento interne: tempo totale di accensione dell'apparecchio.

Ore di funzionamento esterne: tempo totale dei cicli di centrifugazione finora eseguiti.

A rotore fermo è possibile consultare le ore di funzionamento e il numero di cicli di centrifugazione, nella maniera seguente:

- Tenere premuto il pulsante **PROG** per 8 secondi.
Dopo 8 secondi sul display appare ***** Machine Menu *****.
- Premere il pulsante **PROG** fino a che non viene visualizzato -> **Operating Time**.
- Premere il pulsante **START**. Sono visualizzate le ore di funzionamento esterne, per esempio **OP Time ext = 0h25m**.
- Premere il pulsante **PROG**. Sono visualizzate le ore di funzionamento interne, per esempio **OP Time int = 1h36m**.
- Premere il pulsante **PROG**. È visualizzato il numero di cicli di centrifugazione, per esempio **Number of Starts = 10**.
- Premere 2 volte il pulsante **OPEN/STOP** per uscire dal menu "Operating Time", oppure premere 3 volte il pulsante **OPEN/STOP** per uscire da "Machine Menu".

28 Consultazione delle informazioni di sistema

A rotore fermo è possibile consultare le informazioni sul rotore e la versione di programma della centrifuga e del convertitore di frequenza, nella maniera seguente:

- Tenere premuto il pulsante **PROG** per 8 secondi.
Dopo 8 secondi sul display appare ***** Machine Menu *****.
- Premere il pulsante **PROG** fino a che non viene visualizzato -> **Info**.
- Premere il pulsante **START**. Sono visualizzati il codice del rotore (Rotor), la velocità di rotazione massima del rotore (Nmax) e il raggio di centrifugazione preimpostato (R) dell'ultimo rotore riconosciuto tramite l'apposito sistema di riconoscimento, per esempio **Rotor 4*: Nmax = 4500 R=184**.
L'ultimo rotore riconosciuto è contrassegnato da un asterisco (*). Con la manopola **○** è ora possibile visualizzare le informazioni riguardanti i rotori fatti entrare nella centrifuga.
- Premere il pulsante **PROG**. È visualizzata la versione di programma della centrifuga, per esempio **SW-Version = 01.00**.
- Premere il pulsante **PROG**. È visualizzata la versione di programma del convertitore di frequenza, per esempio **FC-SW-Version = 4**.
- Premere 2 volte il pulsante **OPEN/STOP** per uscire dal menu "Info", oppure premere 3 volte il pulsante **OPEN/STOP** per uscire dal menu "Machine Menu".

29 Visualizzazione immediata dei dati di centrifugazione dopo l'accensione

- Accendere l'interruttore di rete (posizione dell'interruttore **I**).
- Alla prima variazione ottica della visualizzazione (visualizzazione con i colori invertiti) tenere premuto un pulsante qualsiasi. Sono mostrati immediatamente i dati di centrifugazione.

30 Raffreddamento (solo per centrifuga con raffreddamento)

Il valore nominale di temperatura può essere selezionata da -20°C fino a +40°C / -4°F fino a +104°F. Nelle centrifughe con l'opzione di riscaldamento/ raffreddamento, il valore nominale della temperatura è regolabile da -20°C a +90°C / -4°F fino a +194°F. La temperatura minima raggiungibile dipende dal rotore (vedere capitolo "Anhang/Appendix, Rotoren und Zubehör/Rotors and accessories").

30.1 Raffreddamento-Standby

A rotore fermo e a coperchio chiuso la camera centrifuga viene refrigerata alla temperatura preselezionata se questa è inferiore ai 20°C / 68°F.

Durante la refrigerazione in modalità di standby viene visualizzata la temperatura preselezionata.

30.2 Preraffreddamento del rotore



Per un veloce raffreddamento del rotore in condizione di non caricato e dell'accessorio, consigliamo uno svolgimento di centrifugazione con le impostazioni di funzionamneto continuo ed un regime di rotazione di ca. 20% del regime di rotazione max. del rotore.

Il preraffreddamento avviene in modo automatico con il programma **PREC** (PRECOOLING).

Un preraffreddamento non è possibile quando il lavoro avviene con concatenamenti di programmi.

- Premere il pulsante . Il LED presente nel pulsante lampeggia fino a che il rotore non viene letto, poi il LED si illumina con luce fissa.
- Allo scadere del tempo o in caso di interruzione del ciclo di centrifugazione premendo il pulsante , viene eseguito l'arresto con il relativo parametro selezionato. Il parametro di arresto viene visualizzato, per esempio 9. Il LED destro presente nel pulsante si illumina. Una volta che il rotore si è fermato, il LED presente nel pulsante si spegne e viene visualizzato **OPEN** / **OEFFNEN** (APRIRE). Si spegne anche il LED destro presente nel pulsante , il LED sinistro nel pulsante inizia a lampeggiare e continua a farlo fino a che non si apre il coperchio.

Durante il ciclo di centrifugazione sono visualizzati la velocità di rotazione del rotore o il valore RCF risultante, la temperatura delle provette e il tempo rimanente oppure quello trascorso.

31 Riscaldamento (solo per centrifughe con opzione di riscaldamento/ raffreddamento)

Durante il processo di centrifuga, in caso di necessità, il vano di centrifugazione può essere riscaldato alla temperatura preimpostata.

Al fermo del rotore, il riscaldamento è spento.



Pericolo di combustione! La temperatura superficiale dell'elemento riscaldante nella camera di centrifugazione della centrifuga può raggiungere 500°C / 932°F. Non toccare l'elemento riscaldante.



Le sospensioni di plastica possono essere utilizzate solamente a temperature fino a massimo 40° C / 104° F.

32 Accelerazione centrifuga relativa (RCF)

L'accelerazione centrifuga relativa (RCF) è indicata come un multiplo dell'accelerazione terrestre (g). È un valore numerico privo di unità e funge per paragonare le prestazioni di separazione de sedimentazione.

Il calcolo viene eseguito in base alla formula:

$$RCF = \left(\frac{RPM}{1000} \right)^2 \times r \times 1,118 \quad \Rightarrow \quad RPM = \sqrt{\frac{RCF}{r \times 1,118}} \times 1000$$

RCF = accelerazione centrifuga relativa

RPM = numero dei giri

r = raggio di centrifugazione in mm = distanza dal centro dell'asse di rotazione fino al fondo del recipiente di centrifugazione. Raggio di centrifugazione vedi al capitolo "Anhang/Appendix, Rotoren und Zubehör/Rotors and accessories".



L'accelerazione centrifuga relativa (RCF) dipende dal numero dei giri e dal raggio di centrifugazione.

33 Centrifugazione di sostanze o di miscele di sostanze con densità maggiore di 1,2 kg/dm³

In caso di centrifugazione con massimo numero di giri, la densità dei materiali o delle miscele di materiali non deve superare il valore di composizione di 1,2 kg/dm³.

Con sostanze o miscele di sostanze di densità maggiore, il regime di rotazione deve venire ridotto.

Il numero di giri consentito si calcola con la formula seguente:

$$\text{numero di giri ridotto (n}_{\text{red}}) = \sqrt{\frac{1,2}{\text{densità maggiore [kg/dm}^3]}} \times \text{regime massimo di rotazione [RPM]}$$

p.es.: regime massimo di rotazione RPM 4000, densità 1,6 kg/dm³

$$n_{\text{red}} = \sqrt{\frac{1,2 \text{ kg/dm}^3}{1,6 \text{ kg/dm}^3}} \times 4000 \text{ RPM} = 3464 \text{ RPM}$$

Se in casi eccezionali viene superato il carico massimo indicato sul gancio, il regime di rotazione deve essere ridotto.

Il numero di giri consentito si calcola con la formula seguente:

$$\text{numero di giri ridotto (n}_{\text{red}}) = \sqrt{\frac{\text{carico massimo [g]}}{\text{carico effettivo [g]}}} \times \text{regime massimo di rotazione [RPM]}$$

p.es.: regime massimo di rotazione RPM 4000, carico massimo 350 g, carico effettivo 300 g



$$n_{\text{red}} = \sqrt{\frac{300 \text{ g}}{350 \text{ g}}} \times 4000 \text{ RPM} = 3703 \text{ RPM}$$

In caso di dubbio, rivolgersi al costruttore per maggiori informazioni.

34 Riconoscimento del rotore

Con l'inizio di ogni corsa di centrifugazione, avviene il riconoscimento del rotore installato.

Dopo una sostituzione del rotore l'azionamento si disinserisce e sono visualizzati il codice del rotore (Rotor), la velocità di rotazione massima del rotore (Nmax) e il raggio di centrifugazione preimpostato (R) del rotore utilizzato, per esempio **Rotor 4 Nmax= 4500 R=184 mm**.

- Premere il pulsante  per aprire il coperchio, oppure premere il pulsante  per avviare il ciclo di centrifugazione. Nelle centrifughe con refrigerazione si può anche premere il pulsante  per avviare la prerrefrigerazione del rotore.



Se dopo un cambio del rotore il numero di giri massimo del rotore è inferiore al numero di giri impostato, la velocità viene limitata al numero di giri massimo del rotore. In questo caso il numero della posizione di programma viene visualizzato tra parentesi ().



35 Sblocco di emergenza

In caso di una caduta di tensione, il coperchio non può essere sbloccato a motore. Deve essere effettuata manualmente uno sblocco di emergenza.



Per lo sblocco di emergenza, disconnettere la centrifuga dalla rete elettrica.
Aprire il coperchio solo con l'arresto del rotore.

Vedere illustrazione alla pagina 2.

- Disinserire l'interruttore di rete (posizione interruttore "0").
- Guardare attraverso la finestra presente nel coperchio per assicurarsi che il rotore sia fermo.
- Introdurre la chiave per viti Allen nel foro (Fig. 1, A) e ruotarla con cautela di mezzo giro in senso orario, fino ad aprire il coperchio.
- Strappare la vite senza testa esagonale dal foro.
- Quando dopo il reinserimento della centrifuga lampeggia il LED di sinistra nel tasto , premere il tasto  in modo che il bloccaggio motorico del coperchio prenda la posizione di base (aperto).

36 Pulizia e manutenzione



Prima della pulizia, staccare la presa di corrente.

Prima di iniziare un procedimento di pulizia e decontaminazione diverso da quello consigliato dal produttore, l'utilizzatore deve accertarsi presso il produttore che tale procedimento previsto non rechi danno all'apparecchio.

- Centrifughe, rotori e accessori non devono essere lavati in lavastoviglie.
- Si deve eseguire solo una pulizia manuale ed una disinfezione con liquido.
- La temperatura dell'acqua deve essere di 20 – 25°C.
- Devono essere utilizzati solo detersivi o disinfettanti che:
 - abbiano un campo di valori del pH che va da 5 a 8,
 - non contengano alcali caustici, perossidi, composti di cloro, acidi e soluzioni alcaline.
- Seguire attentamente le indicazioni speciali del produttore sull'impiego di detersivi e disinfettanti, al fine di evitare qualsiasi fenomeno di corrosione.

36.1 Centrifughe (scatola, coperchio e vano di centrifugazione)

36.1.1 Cura e pulizia delle superfici

- Pulire regolarmente il corpo della centrifuga e la camera di centrifugazione e impiegare all'occorrenza sapone o un detersivo delicato e un panno umido. Ciò serve da un lato per l'igiene e dall'altro lato per evitare la corrosione causata da impurità incrostate.
- Ingredienti dei detersivi adatti:
sapone, tensidi anionici, tensidi non ionici.
- Dopo l'impiego di detersivi, rimuovere i resti del detersivo pulendo di nuovo con un panno umido.
- Le superfici devono essere asciugate subito dopo la pulizia.
- In caso di formazione di acqua di condensa, asciugare la camera di centrifugazione pulendola con un panno assorbente.
- Spalmare sulla guarnizione di gomma della camera di centrifugazione, frizionando leggermente, polvere di talco o una sostanza per la cura della gomma.
- Controllare una volta l'anno se il vano di centrifugazione presenta danneggiamenti.



Se vengono stabiliti danni rilevanti per la sicurezza, la centrifuga non deve essere più messa in funzione. In questo caso si deve contattare il servizio assistenza clienti.

36.1.2 Disinfezione delle superfici

- In presenza di materiale infettivo nella camera di centrifugazione si deve disinfettarla immediatamente.
- Ingredienti dei disinfettanti adatti:
etanolo, alcol n proclitico, isopropanolo, glutaraldeide, composti di ammonio quaternario.
- Dopo l'impiego di disinfettanti, rimuovere i resti del disinfettante pulendo di nuovo con un panno umido.
- Le superfici devono essere asciugate subito dopo la disinfezione.

36.1.3 Rimuovere contaminazioni radioattive

- La sostanza deve essere certificata in modo speciale per rimuovere contaminazioni radioattive.
- Ingredienti di sostanze adatte alla rimozione di contaminazioni radioattive:
tensidi anionici, tensidi non ionici, etanolo poliidrato.
- Dopo aver rimosso le contaminazioni radioattive, rimuovere i resti della sostanza pulendo di nuovo con un panno umido.
- Le superfici devono essere asciugate, subito dopo la rimozione delle contaminazioni radioattive.

36.2 Rotori ed accessori

36.2.1 Pulizia e cura

- Per evitare che il materiale si corroda o subisca variazione, i rotor e i pezzi accessori devono essere puliti regolarmente con sapone o un detergente delicato e un panno umido. Si consiglia la pulizia almeno una volta la settimana. La sporcizia deve essere subito rimossa.
- Ingredienti dei detergenti adatti:
sapone, tensidi anionici, tensidi non ionici.
- Dopo l'impiego di detergenti, rimuovere i resti del detergente, risciacquando con acqua (solo al di fuori della centrifuga) o ripulendo con un panno umido.
- I rotor e gli accessori devono essere asciugati immediatamente dopo la pulizia.
- I rotor ad angolo, i contenitori e i supporti in alluminio devono essere ingrassati leggermente con grasso privo d'acidi come ad esempio vaselina quando sono ben asciutti.
- Nei sistemi di sicurezza biologici (Per quanto riguarda i sistemi biologici di sicurezza fornibili, rimandiamo al capitolo "Anhang/Appendix, Rotoren und Zubehör/Rotors and accessories") gli anelli di guarnizione devono essere controllati e puliti periodicamente (ogni settimana). In presenza di crepe, parti fragili o logorio, l'anello di tenuta deve essere subito sostituito. Per evitare che durante l'apertura e la chiusura del coperchio l'anello di guarnizione si giri, spalmarvi, frizionando leggermente, polvere di talco o una sostanza per la cura della gomma.
- Per evitare la corrosione causata dall'umidità tra il rotore e l'albero motore, si deve provvedere almeno una volta al mese di smontare il rotore, pulirlo e di lubrificare leggermente l'albero motore.
- I rotor e gli elementi accessori devono essere verificati mensilmente per quanto riguarda il loro stato di usura ed i danneggiamenti da corrosione.
Con i motori di smorzamento devono essere verificati soprattutto il settore dei perni di supporto e per i ganci le scanalature, verificare inoltre l'eventuale presenza di incrinature nel fondo.



Rotori ed accessori non devono essere più utilizzati se presentano consumo o corrosione.

- Verificare settimanalmente la posizione del rotore.

36.2.2 Disinfezione

- Se del materiale infetto viene a contatto con i rotor o con gli accessori, allora si deve eseguire una disinfezione adeguata.
- Ingredienti dei disinfettanti adatti:
glutaraldeide, propanolo, etilexanolo, tensidi anionici, inibitori di corrosione.
- Dopo l'impiego di disinfettanti, rimuovere i resti del disinfettante, risciacquando con acqua (solo al di fuori della centrifuga) o ripulendo con un panno umido.
- I rotor e gli accessori devono essere asciugati immediatamente dopo la disinfezione.

36.2.3 Rimuovere contaminazioni radioattive

- La sostanza deve essere certificata in special modo per rimuovere contaminazioni radioattive.
- Ingredienti di sostanze adatte alla rimozione di contaminazioni radioattive:
tensidi anionici, tensidi non ionici, etanolo poliidrato.
- Dopo la rimozione delle contaminazioni radioattive, rimuovere la sostanza, risciacquando con acqua (solo al di fuori della centrifuga) o ripulendo con un panno umido.
- I rotor e gli accessori devono essere asciugati subito dopo la rimozione delle contaminazioni radioattive.

36.2.4 Perna di trascinamento

In rotor oscillanti, i perni di trascinamento devono essere lubrificati regolarmente (Grasso lubrificante Hettich no. d'ord. 4051) per consentire un'oscillazione equilibrata dei ganci.

36.2.5 Rotori ed accessori con limitata durata di impiego

L'impiego di particolari rotor, ganci ed elementi accessori è limitato nel tempo.

Questi sono contrassegnati con la quantità max. di cicli di funzionamento o dalla data di scadenza ed il numero massimo di cicli di funzionamento o solo con la data di scadenza, p.es.:

- "einsetzbar bis Ende: IV. Quartal 2011 / usable until end of: IV. trimestre 2011" (utilizzabile fino alla fine: IV. trimestre 2011) o
"einsetzbar bis Ende Monat/Jahr: 10/201 / usable until end of month/year: 10/2011" (utilizzabile fino a fine mese/anno: 10/2011)
- "max. Laufzyklen / max. cycles: 40000". (Max. funzionamento cicli)



Per motivi di sicurezza l'impiego dei rotor, dei ganci e degli elementi di accessorio non è più ammesso, quando è raggiunta la quantità massima permessa dei cicli di funzionamento che è sopracontrassegnata o quando è raggiunta la data di scadenza sopracontrassegnata.

La quantità di svolgimenti di centrifugazione può essere interpellata, vedere al capitolo "Interrogazione delle ore di funzionamento e della quantità di svolgimenti di centrifugazione".

36.3 Mantenere in autoclave

I rotor basculanti, i rotor angolari di alluminio, le sospensioni di metallo, i coperchi con chiusura ermetica anti-contaminazione biologica, come pure i telai e le riduzioni possono essere trattati in autoclave a 121° C / 250° F (20 minuti).

In caso di dubbio occorre informarsi presso la casa produttrice.

Non è possibile fare nessuna dichiarazione sul grado di sterilizzazione.



Il coperchio del rotore ed il contenitore devono essere staccati prima di essere riposti in autoclave.

La conservazione in autoclave accelera il processo di invecchiamento del materiale in plastica. Inoltre può causare variazioni di colore nel materiale in plastica.

Dopo il trattamento in autoclave consigliamo di sostituire le guarnizioni ad anello dei sistemi biologici di sicurezza.

36.4 Contenitori centrifuga

- In caso di mancanza di tenuta o dopo la rottura dei contenitori per centrifugazione, rimuovere completamente i frammenti dei contenitori, le schegge di vetro e il centrifugato fuoriuscito.
- Dopo la rottura di parti in vetro, sostituire gli inserti di gomma e i manicotti di plastica dei rotor.



Le schegge di vetro rimaste causano ulteriori rotture!

- Nel caso di materiale infettivo, bisogna provvedere immediatamente ad una disinfezione.

37 Guasti

Se non si riesce a eliminare l'errore seguendo le indicazioni della tabella guasti, informare il servizio assistenza clienti.

Si prega di indicare il tipo di centrifuga e il numero di serie. Entrambi i numeri sono visibili sulla targhetta di modello della centrifuga.

	<p>Esecuzione di un RESET RETE:</p> <ul style="list-style-type: none"> - Disinserire l'interruttore di rete (posizione interruttore "0"). - Attendere almeno 10 secondi quindi reinserire l'interruttore di rete (posizione interruttore "I").
---	--

Visualizzazione/guasto		Causa	Eliminazione
Nessuna visualizzazione		Non c'è tensione. Scatto fusibile sovraccorrente. Intervento dell'interruttore automatico (solo con i tipi 1701-01 e 1706-01).	<ul style="list-style-type: none"> - Controllare alimentatore elettrico. - Reinserrire l'interruttore automatico, vedere il capitolo "Inserire l'interruttore automatico" (solo con i tipi 1701-01 e 1706-01). - Interruttore di rete ON.
TACHO - ERROR	1, 2, 96	Tachimetro difettoso Motore, sistema elettronico difettoso.	<ul style="list-style-type: none"> - Aprire il coperchio. - Disinserire l'interruttore di rete (posizione interruttore "0"). - Attendere per almeno 10 secondi. - Girare energicamente a mano il rotore. - Reinserrire l'interruttore di rete (posizione interruttore "I"). Durante l'inserimento il rotore deve girare.
IMBALANCE		Il rotore è caricato in modo non uniforme.	<ul style="list-style-type: none"> - Aprire il coperchio. - Controllare il caricamento del rotore, vedere il capitolo "Carico del rotore". - Ripetere il ciclo di centrifugazione.
CONTROL - ERROR	4.1 - 4.5, 6	Errore blocco coperchio, ovvero chiusura coperchio.	- Esecuzione di un RESET RETE.
N > MAX	5	N° giri eccedente	
N < MIN	13	N° giri insufficiente	
ROTORCODE	10.1, 10.3	Errore codifica rotore	
MAINS INTERRUPT		Interruzione di rete durante il ciclo di centrifugazione. (Il ciclo di centrifugazione non viene terminato.)	<ul style="list-style-type: none"> - Aprire il coperchio. - Premere tasto  START. - All'occorrenza ripetere il ciclo di centrifugazione.
VERSION-ERROR	12	Non c'è corrispondenza tra i componenti elettronici Guasto/difetto sistema elettronico.	- Esecuzione di un RESET RETE.
CONTROL-ERROR	22, 25.1 - 25.4	Guasto/difetto sistema elettronico.	
SER I/O - ERROR	31, 24, 36	Guasto/difetto sistema elettronico.	
° C * - ERROR	51, 53 - 55, 97, 98	Guasto/difetto sistema elettronico.	
° C * - ERROR	52	Temperatura eccessiva nella camera centrifuga. Guasto/difetto sistema elettronico.	
FU / CCI - ERROR	60, 61.2 - 61.20, 61.128 - 61.131, 62	Guasto/difetto sistema elettronico/motore.	
FU / CCI - ERROR	61.1	Tensione di rete troppo bassa. Guasto/difetto sistema elettronico/motore.	

Visualizzazione/guasto		Causa	Eliminazione
SENSOR-ERROR	90	Guasto/difetto sistema elettronico.	– Esecuzione di un RESET RETE.
SENSOR-ERROR	91 - 93	Guasto/difetto sensore squilibrio.	
NO ROTOR OR ROTORCODE ERROR		Non è installato alcun rotore. Tachimetro difettoso.	– Aprire il coperchio. – Installare il rotore.
WRONG ROTOR !!!		(solo per il tipo 1701-30) È installato un rotore, che non è omologato per il tipo 1701-30.	– Aprire il coperchio. – Installare il rotore 1798.
N > ROTOR MAX		Il numero di giri nel programma selezionato è superiore al numero di giri massimo del rotore.	– Verificare e correggere la velocità nel programma selezionato.
N > ROTOR MAX in Prog : p.es. 3		Sul posto di programma indicato si trova un programma, il cui regime di rotazione è maggiore del regime di rotazione massimo del rotore.	
Runtime 00:00 in Prog : p.es. 3		Sul posto di programma indicato si trova un programma di funzionamento continuo.	– Sostituire nel concatenamento di programma, il programma di funzionamento continuo, con un programma con preselezione tempo.
Empty Program		Sul posto di programma indicato non è memorizzato alcun concatenamento di programmi.	– Richiamare un concatenamento di programmi.
FC INIT ERROR		Guasto/difetto sistema elettronico.	– Esecuzione di un RESET RETE.
FC VERSION ERROR		Guasto/difetto sistema elettronico.	
FATAL EEPROM ERROR	1 - 5	Guasto/difetto sistema elettronico.	

38 Inserire l'interruttore automatico (solo con i tipi 1701-01 e 1706-01)



Disattivare l'interruttore di rete e sezionare la centrifuga dalla rete!

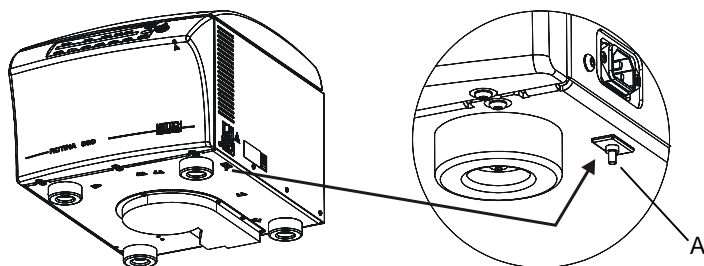

- Premere il piedino di plastica (A) dell'interruttore automatico.
- Collegare di nuovo alla rete la centrifuga.

39 Accettazione di centrifughe da riparare

Nel caso in cui la centrifuga debba essere rispedita al produttore per una eventuale riparazione, prima della spedizione deve essere decontaminata e pulita a fondo a salvaguardia delle persone, dell'ambiente e del materiale.

Ci riserviamo di accettare centrifughe contaminate.

Eventuali costi di pulizia e disinfezione verranno fatturati al cliente.

Contiamo a questo riguardo sulla vostra comprensione.

40 Smaltimento

Prima dello smaltimento, l'apparecchiatura deve essere decontaminata e pulita con lo scopo di proteggere le persone, l'ambiente e il materiale.

Per lo smaltimento dell'apparecchio osservare le rispettive norme di legge.

Ai sensi della direttiva 2002/96/CE (RAEE) tutti gli apparecchi forniti dopo il 13/08/2005 non possono più essere smaltiti con i rifiuti domestici. Questo apparecchio appartiene alla categoria 8 (Dispositivi medicali) ed è classificato nel settore Business-to-Business.













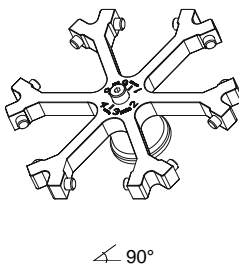





Il simbolo della pattumiera cancellata con una croce indica che l'apparecchio non deve essere smaltito con i rifiuti domestici.











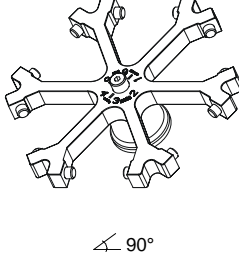

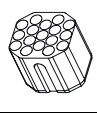

Le norme per lo smaltimento possono essere differenti nei singoli paesi UE. In caso di necessità rivolgersi al proprio rivenditore.

41 Anhang / Appendix

41.1 Rotoren und Zubehör / Rotors and accessories

41.1.1 ROTINA 380 / 380 R, Typen / types 1701, 1701-01, 1706, 1706-01

1726		1308	1345	1346	1366						
Ausschwingrotor 6-fach / Swing out rotor 6-times  90°			 11)	 11)							
					1326	1327	1357	5277			
		0521					Rhesus	---	2078	0536	
											
Kapazität / capacity	ml	50	45	20	4	3	1	0,4	1,5	2,0	
Maße / dimensions	∅ x L	mm	34 x 100	31 x 100	21 x 100	12 x 60	10 x 60	6 x 45	6 x 45	11 x 38	
Anzahl p. Rotor / number p. rotor		6	6	12	72	72	180	180	54		
Drehzahl / speed	RPM	4000	4000	4000	4000	4000	4000	4000	4000		
RZB / RCF		2647	2719	2719	2290	2290	2308	2308	2325		
Radius / radius	mm	148	152	152	128	128	129	129	130		
 9 (97%)	sec						19				
 9	sec						≥ 18				
Temperatur / temperature	°C ¹⁾						- 6				
Probenerwärmung/Sample temp. rise	K ²⁾						9				

1726		1369		1369-91	1369-92		1370	1372			
Ausschwingrotor 6-fach / Swing out rotor 6-times  90°		 11)		 6) 11)	 6) 11)		 11)				
		0507		0518	0553	0501	0578	0500	0553		
											
Kapazität / capacity	ml	15	8,5 - 10	15	5	6	7	9	5		
Maße / dimensions	∅ x L	mm	17 x 100	16 x 100	17 x 100	12 x 75	12 x 82	12 x 100	14 x 100	12 x 75	
Anzahl p. Rotor / number p. rotor		24	24	24	24	24	24	30	102		
Drehzahl / speed	RPM	4000	4000	4000	4000	4000	4000	4000	4000		
RZB / RCF		2665	2665	2665	2576	2665	2665	2665	2522		
Radius / radius	mm	149	149	149	144	149	149	149	141		
 9 (97%)	sec						19				
 9	sec						≥ 18				
Temperatur / temperature	°C ¹⁾						- 6				
Probenerwärmung/Sample temp. rise	K ²⁾						9				

1) Tiefste erreichbare Temperatur bei maximaler Drehzahl, 1 h Laufzeit und 20°C Raumtemperatur (nur bei Kühlzentrifuge)

2) Probenerwärmung bei maximaler Drehzahl und 1 h Laufzeit (nur bei Zentrifuge ohne Kühlung)

6) mit Dekantierhilfe











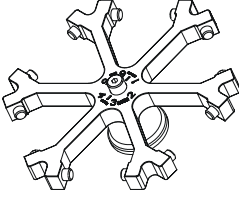





11) Kunststoff-Nutgehänge dürfen nur bei Temperaturen bis maximal 40°C / 104°F verwendet werden.









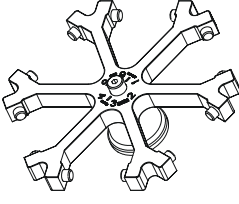

1) Lowest possible temperature during maximum speed, 1 h running time and 20°C ambient temperature (only with cooling centrifuges)

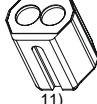
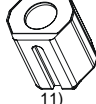
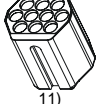
2) Sample temp. rise during maximum speed and 1 h running time (only with centrifuges without cooling)

6) with decanting aid

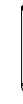
11) Plastic suspension can only be used in temperatures up to a maximum of 40°C / 104°F.

1726	1741		1742								
Ausschwingrotor 6-fach / Swing out rotor 6-times  $\angle 90^\circ$	 11)		 11)								
	0701		0716								
											
					 *)						
Kapazität / capacity ml	4,9	4,5 - 5	9	1,1 - 1,4	15	15	15	2,6 - 2,9	4 - 4,5	1,6 - 5	4-7
Maße / dimensions \varnothing x L mm	13 x 90	11 x 92	14 x 100	8 x 66	17 x 100	17 x 120	17 x 100	13 x 65	15 x 75	13 x 75	16 x 75
Anzahl p. Rotor / number p. rotor	60		60	60	42	18	42	42		42	
Drehzahl / speed RPM	4000		4000	4000	4000	4000	4000	4000		4000	
RZB / RCF	2808		2773	2773	2808	2808	2808	2683		2683	
Radius / radius mm	157		155	155	157	157	157	150		150	
 9 (97%) sec					19						
 9 sec					≥ 18						
Temperatur / temperature $^\circ\text{C}$ ¹⁾					- 6						
Probenerwärmung/Sample temp. rise K ²⁾					9						

1726	1742		1745	1746	1741				
Ausschwingrotor 6-fach / Swing out rotor 6-times  $\angle 90^\circ$	 11)		 11)	 11)	 11)	SK 13.06 11)			
			 *)						
Kapazität / capacity ml	7,5 - 8,2	9-10	10	8,5 - 10	30	50	4 - 7	25	
Maße / dimensions \varnothing x L mm	15 x 92	16 x 92	15 x 102	16 x 100	26 x 95	34 x 100	13 x 100	24 x 100	
Anzahl p. Rotor / number p. rotor	42		18	42	12	6	60	12	
Drehzahl / speed RPM	4000		4000	4000	4000	4000	4000	4000	
RZB / RCF	2808		2808	2808	2808	2808	2808	2683	
Radius / radius mm	157		157	157	157	157	157	150	
 9 (97%) sec					19				
 9 sec					≥ 18				
Temperatur / temperature $^\circ\text{C}$ ¹⁾					- 6				
Probenerwärmung/Sample temp. rise K ²⁾					9				

1) Tiefste erreichbare Temperatur bei maximaler Drehzahl, 1 h Laufzeit und 20°C Raumtemperatur (nur bei Kühlzentrifuge)

2) Probenerwärmung bei maximaler Drehzahl und 1 h Laufzeit (nur bei Zentrifuge ohne Kühlung)

*) nur die mittlere Reihe belegen









11) Kunststoff-Nutgehänge dürfen nur bei Temperaturen bis maximal 40°C / 104°F verwendet werden.

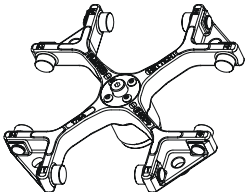

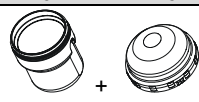



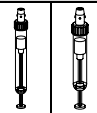

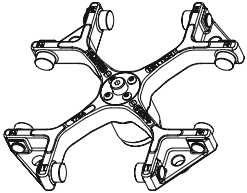

1) Lowest possible temperature during maximum speed, 1 h running time and 20°C ambient temperature (only with cooling centrifuges)

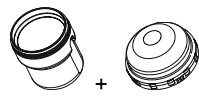
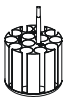
2) Sample temp. rise during maximum speed and 1 h running time (only with centrifuges without cooling)

*) load only the middle row











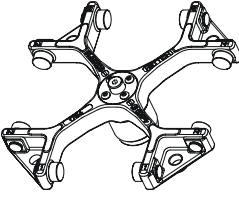

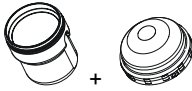
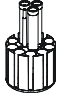

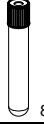
11) Plastic suspension can only be used in temperatures up to a maximum of 40°C / 104°F.











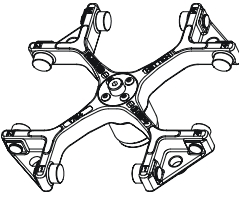

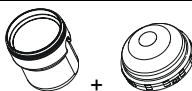
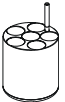
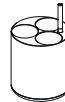
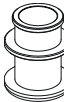
1754		1752 + 1751									
Ausschwingrotor 4-fach / Swing out rotor 4-times  		 mit Bioabdichtung / with bio-containment 10)									
		1761					1762				
											
		2078	0536	----	---	0553	0501	0578			
Kapazität / capacity ml		1,5	2,0	3	4	5	6	7	2,7 - 3	4,5 - 5	
Maße / dimensions Ø x L mm		11 x 38	11 x 38	10 x 60	12 x 60	12 x 75	12 x 82	12 x 100	11 x 66	11 x 92	
Anzahl p. Rotor / number p. rotor		144	144	72	96	96	96	96	96		
Drehzahl / speed RPM		5000	5000	5000	5000	5000	5000	5000	5000		
RZB / RCF ³⁾		4779/3494	4779/3494	4779	4668	4668	4668	4668	4668		
Radius / radius mm		171/125	171/125	171	167	167	167	167	167		
 9 (97%) sec		42									
 9 sec		≥ 27									
Temperatur / temperature °C ¹⁾		0									
Probenerwärmung/Sample temp. rise K ²⁾		13									

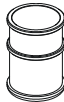
1754		1752 + 1751									
Ausschwingrotor 4-fach / Swing out rotor 4-times  		 mit Bioabdichtung / with bio-containment 10)									
		1763-A									
											
		0500	2079	0507							
Kapazität / capacity ml		9	10	15	10	8	4,5 - 5	7,5 - 8,2	9 - 10		
Maße / dimensions Ø x L mm		14 x 100	17 x 70	17 x 100	16 x 80	16 x 81	15 x 75	15 x 92	16 x 92		
Anzahl p. Rotor / number p. rotor		52	52	52	52	52	52	52	52		
Drehzahl / speed RPM		5000	5000	5000	5000	5000	5000	5000	5000		
RZB / RCF ³⁾		4668	4668	4668	4668	4668	4668	4668	4668		
Radius / radius mm		167	167	167	167	167	167	167	167		
 9 (97%) sec		42									
 9 sec		≥ 27									
Temperatur / temperature °C ¹⁾		0									
Probenerwärmung/Sample temp. rise K ²⁾		13									

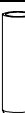
- 1) Tiefste erreichbare Temperatur bei maximaler Drehzahl, 1 h Laufzeit und 20°C Raumtemperatur (nur bei Kühlzentrifuge)
- 2) Probenerwärmung bei maximaler Drehzahl und 1 h Laufzeit (nur bei Zentrifuge ohne Kühlung)
- 3) Zentrifugiergefäße aus Glas nur belastbar bis RZB 4000
- 10) Nach DIN EN 61010, Teil 2 – 020. Die Hinweise für Bio-Sicherheitssysteme in den Kapiteln "Sicherheitshinweise" und "Pflege und Wartung" beachten.











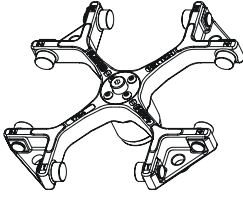

- 1) Lowest possible temperature during maximum speed, 1 h running time and 20°C ambient temperature (only with cooling centrifuges)
- 2) Sample temp. rise during maximum speed and 1 h running time (only with centrifuges without cooling)
- 3) Centrifuge containers of glass will not stand RCF values exceeding 4000
- 10) in conformity with DIN EN 61010, part 2 – 020. Observe the notes for bio safety systems in chapters "Notes on safety" and "Maintenance and servicing".

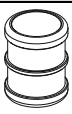
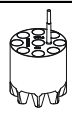
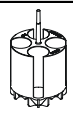
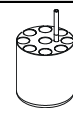
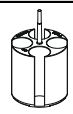
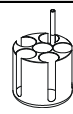
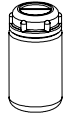
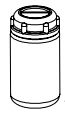







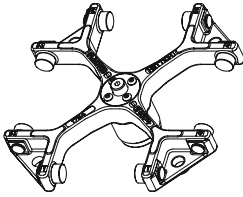

1754	1752 + 1751							
Ausschwingrotor 4-fach / Swing out rotor 4-times  	 mit Bioabdichtung / with bio-containment 10)							
	1763-A							
								
								
Kapazität / capacity ml	8 ⁸⁾	4 - 7	8,5 - 10	14	12	10	15	
Maße / dimensions Ø x L mm	16 x 125	16 x 75	16 x 100	16,5 x 106	16 x 101	15 x 102	17 x 100	
Anzahl p. Rotor / number p. rotor	12	52	52	52	52	52	52	
Drehzahl / speed RPM	5000	5000	5000	5000	5000	5000	5000	
RZB / RCF ³⁾	4668	4668	4668	4668	4668	4668	4668	
Radius / radius mm	167	167	167	167	167	167	167	
 9 (97%)				42				
 9				≥ 27				
Temperatur / temperature °C ¹⁾	0							
Probenerwärmung/Sample temp. rise K ²⁾	13							

1754	1752 + 1751										
Ausschwingrotor 4-fach / Swing out rotor 4-times  	 mit Bioabdichtung / with bio-containment 10)										
	1764		1765			1766	1767	1768			
											
		0519		0521		0548		0526		0523	
Kapazität / capacity ml	20	25	45	50	75	100	100	250			
Maße / dimensions Ø x L mm	21 x 100	24 x 100	31 x 100	34 x 100	35 x 105	44 x 100	40 x 115	65 x 115			
Anzahl p. Rotor / number p. rotor	24	24	12	12	12	4	4	4			
Drehzahl / speed RPM	5000	5000	5000	5000	5000	5000	5000	5000			
RZB / RCF ³⁾	4668	4668	4668	4668	4668	4640	4640	4640			
Radius / radius mm	167	167	167	167	167	166	166	166			
 9 (97%)				42							
 9				≥ 27							
Temperatur / temperature °C ¹⁾	0										
Probenerwärmung/Sample temp. rise K ²⁾	13										

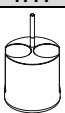
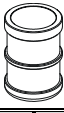
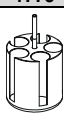
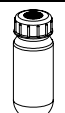
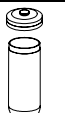
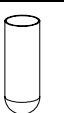
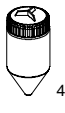
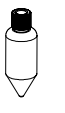
- 1) Tiefste erreichbare Temperatur bei maximaler Drehzahl, 1 h Laufzeit und 20°C Raumtemperatur (nur bei Kühlzentrifuge)
- 2) Probenerwärmung bei maximaler Drehzahl und 1 h Laufzeit (nur bei Zentrifuge ohne Kühlung)
- 3) Zentrifugiergefäße aus Glas nur belastbar bis RZB 4000
- 8) nur inneren Lochkreis belegen
- 10) Nach DIN EN 61010, Teil 2 – 020. Die Hinweise für Bio-Sicherheitssysteme in den Kapiteln "Sicherheitshinweise" und "Pflege und Wartung" beachten.











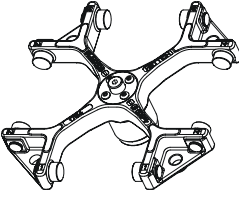

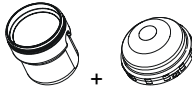
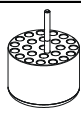
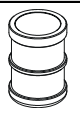
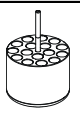

- 1) Lowest possible temperature during maximum speed, 1 h running time and 20°C ambient temperature (only with cooling centrifuges)
- 2) Sample temp. rise during maximum speed and 1 h running time (only with centrifuges without cooling)
- 3) Centrifuge containers of glass will not stand RCF values exceeding 4000
- 8) load only the inner hole circle
- 10) in conformity with DIN EN 61010, part 2 – 020. Observe the notes for bio safety systems in chapters "Notes on safety" and "Maintenance and servicing".







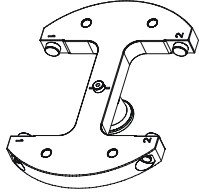

1754		1752 + 1751															
Ausschwingrotor 4-fach / Swing out rotor 4-times  		 +  mit Bioabdichtung / with bio-containment 10)															
		1769		1771		1772		1773		1774-A		1775					
																	
		4)		5127		0509		0513		---		0546		0545			
 14)		 14)															
Kapazität / capacity	ml	290		250		15		50		12		50		50		30	
Maße / dimensions	Ø x L	62 x 137		62 x 122		17 x 120		29 x 115		17 x 100		29 x 107		29 x 115		26 x 95	
Anzahl p. Rotor / number p. rotor		4		4		36		16		36		16		16		24	
Drehzahl / speed	RPM	5000		5000		5000		5000		5000		5000		5000		5000	
RZB / RCF	³⁾	4863		4863		4863		4863		4696		4752		4752		4807	
Radius / radius	mm	174		174		174		174		168		170		170		172	
 9 (97%)	sec											42					
 9	sec											≥ 27					
Temperatur / temperature	°C ¹⁾											0					
Probenerwärmung/Sample temp. rise	K ²⁾											13					

1754		1752 + 1751															
Ausschwingrotor 4-fach / Swing out rotor 4-times  		 +  mit Bioabdichtung / with bio-containment 10)															
		1777				1778		1779									
																	
		0547		0539 / 0538		0549		Nalgene [®]		Nunc [®]							
						 4)											
Kapazität / capacity	ml	85		94		85		175		200		25		30		30	
Maße / dimensions	Ø x L	38 x 106		38 x 106		38 x 106		62 x 144		60 x 130		25 x 90		25 x 110		25 x 110	
Anzahl p. Rotor / number p. rotor		8		8		8		4		4		20		20		20	
Drehzahl / speed	RPM	5000		5000		5000		5000		5000		5000		5000		5000	
RZB / RCF	³⁾	4807		4807		4807		4863		4863		4528		4528		4528	
Radius / radius	mm	172		172		172		174		174		162		162		162	
 9 (97%)	sec											42					
 9	sec											≥ 27					
Temperatur / temperature	°C ¹⁾											0					
Probenerwärmung/Sample temp. rise	K ²⁾											13					

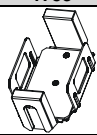
- 1) Tiefste erreichbare Temperatur bei maximaler Drehzahl, 1 h Laufzeit und 20°C Raumtemperatur (nur bei Kühlzentrifuge)
- 2) Probenerwärmung bei maximaler Drehzahl und 1 h Laufzeit (nur bei Zentrifuge ohne Kühlung)
- 3) Zentrifugiergefäße aus Glas nur belastbar bis RZB 4000
- 4) 1752 nicht mit Deckel 1751 verschließbar
- 10) Nach DIN EN 61010, Teil 2 – 020. Die Hinweise für Bio-Sicherheitssysteme in den Kapiteln "Sicherheitshinweise" und "Pflege und Wartung" beachten.
- 14) Bei Temperaturen über 40 °C und/oder geringer Befüllung der Gefäße können sich diese verformen.

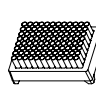
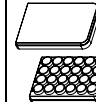
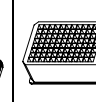
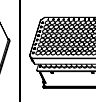
- 1) Lowest possible temperature during maximum speed, 1 h running time and 20°C ambient temperature (only with cooling centrifuges)
- 2) Sample temp. rise during maximum speed and 1 h running time (only with centrifuges without cooling)
- 3) Centrifuge containers of glass will not stand RCF values exceeding 4000
- 4) 1752 cannot be closed with lid 1751
- 10) in conformity with DIN EN 61010, part 2 – 020. Observe the notes for bio safety systems in chapters "Notes on safety" and "Maintenance and servicing".
- 14) At temperatures above 40 °C and/or poor filling of the tubes, these can go out of shape.

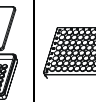
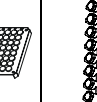
1754		1752 + 1751								
Ausschwingrotor 4-fach / Swing out rotor 4-times  		 mit Bioabdichtung / with bio-containment 10)								
		1781			1782			1783		
										
										
Kapazität / capacity	ml	1,1 – 1,4	225	175	10	2,6 - 2,9	4,9	1,6 - 5	4 - 7	5
Maße / dimensions	Ø x L mm	8 x 66	61 x 137	61 x 118	13 x 100	13 x 65	13 x 90	13 x 75	13 x 100	13 x 75
Anzahl p. Rotor / number p. rotor		96	4	4	64	64	64	64	64	64
Drehzahl / speed	RPM	5000	5000	5000	5000	5000	5000	5000	5000	5000
RZB / RCF	³⁾	4668	4863	4863	4668	4668	4668	4668	4668	4668
Radius / radius	mm	167	174	174	167	167	167	167	167	167
 9 (97%)	sec	42								
 9	sec	≥ 27								
Temperatur / temperature	°C ¹⁾	0								
Probenerwärmung/Sample temp. rise	K ²⁾	13								

1760		1753								
Ausschwingrotor 2-fach / Swing out rotor 2-times  										
									1485	
										
		MTP	MS	CP	DWP	QP	Microtest-platten / plate Terasaki	96-PCR-Platte / plate	PCR-Strips	
										
Kapazität / capacity	ml									0,2
Maße / dimensions TxBxH / DxWxH	mm	86x128x17,5/ 86x128x15 9)	86x128x46	86x128x22	86x128x44,5	86x128x83	59x84x11	82x124x20	---	
Anzahl p. Rotor / number p. rotor		8 / 10 9)	2	6	2	2	4	2	48 x 8	
Drehzahl / speed	RPM	4000	4000	4000	4000	4000	4000	4000	4000	
RZB / RCF		2397	2397	2397	2397	2397	2397	2397	2397	
Radius / radius	mm	134	134	134	134	134	134	134	134	
 9 (97%)	sec									30
 9	sec									≥ 23
Temperatur / temperature	°C ¹⁾									- 8
Probenerwärmung/Sample temp. Rise	K ²⁾									15

1) Tiefste erreichbare Temperatur bei maximaler Drehzahl, 1 h Laufzeit und 20°C Raumtemperatur (nur bei Kühlzentrifuge)

2) Probenerwärmung bei maximaler Drehzahl und 1 h Laufzeit (nur bei Zentrifuge ohne Kühlung)

3) Zentrifugiergefäße aus Glas nur belastbar bis RZB 4000

10) Nach DIN EN 61010, Teil 2 – 020. Die Hinweise für Bio-Sicherheitssysteme in den Kapiteln "Sicherheitshinweise" und "Pflege und Wartung" beachten.

1) Lowest possible temperature during maximum speed, 1 h running time and 20°C ambient temperature (only with cooling centrifuges)

2) Sample temp. rise during maximum speed and 1 h running time (only with centrifuges without cooling)

3) Centrifuge containers of glass will not stand RCF values exceeding 4000

10) in conformity with DIN EN 61010, part 2 – 020. Observe the notes for bio safety systems in chapters "Notes on safety" and "Maintenance and servicing".

MTP Mikrotiterplatte / Microtitre plate











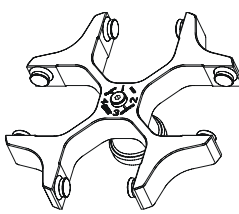



9) MTP ohne Deckel











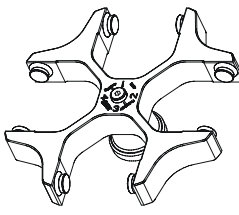

CP Kulturplatte / Culture plate

DWP Deep Well Platte / Deep well plate

9) MTP without lid











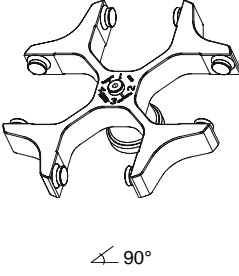





MS Micronic System / Micronic system











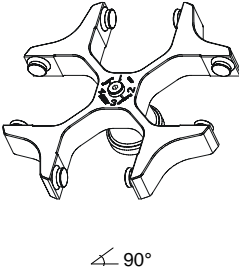



1798		5051 + 5053									
Ausschwingrotor 4-fach / Swing out rotor 4-times  		 									
		5227		5242		5243		5243		5247	
						 2 x 6316					
		0553	0501			0519	 4)	0521	0578		
Kapazität / capacity	ml	5	6	2,7 – 3	4,5 – 5	25	50	50	7		
Maße / dimensions	∅ x L mm	12 x 75	12 x 82	11 x 66	11 x 92	24 x 100	29 x 115	34 x 100	12 x 100		
Anzahl p. Rotor / number p. rotor		80	80	80	80	20	8	8	80		
Drehzahl / speed	RPM	4000	4000	4000	4000	4000	4000	4000	4000		
RZB / RCF		2773	2773	2773	2773	2755	2755	2755	2755		
Radius / radius	mm	155	155	155	155	154	154	154	154		
 9 (97%)	sec	24									
 9	sec	≥ 17									
Temperatur / temperature	°C ¹⁾	- 8									
Probenerwärmung/Sample temp. Rise	K ²⁾	11									

1798		5051 + 5053										
Ausschwingrotor 4-fach / Swing out rotor 4-times  		 										
		5247-91		5248			5248-91		5249		5257	
		 6)					 6)					
		0578	0507	----	0518	0507	0518	0523	2078 		0536 	
Kapazität / capacity	ml	7	15	8,5 - 10	15	15	15	100	1,5	2,0		
Maße / dimensions	∅ x L mm	12 x 100	17 x 100	16 x 100	17 x 100	17 x 100	17 x 100	40 x 115	11 x 38			
Anzahl p. Rotor / number p. rotor		80	48	48	48	48	48	4	160			
Drehzahl / speed	RPM	4000	4000	4000	4000	4000	4000	4000	4000			
RZB / RCF		2755	2755	2755	2755	2755	2755	2755	1950/2826			
Radius / radius	mm	154	154	154	154	154	154	154	109/158			
 9 (97%)	sec	24										
 9	sec	≥ 17										
Temperatur / temperature	°C ¹⁾	- 8										
Probenerwärmung/Sample temp. rise	K ²⁾	11										

- 1) Tiefste erreichbare Temperatur bei maximaler Drehzahl, 1 h Laufzeit und 20°C Raumtemperatur (nur bei Kühlzentrifuge)
- 2) Probenerwärmung bei maximaler Drehzahl und 1 h Laufzeit (nur bei Zentrifuge ohne Kühlung)
- 4) 5051 nicht mit Deckel 5053 verschließbar
- 6) mit Dekantierhilfe











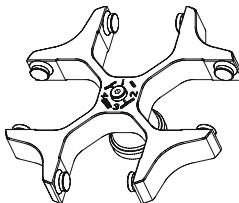

- 1) Lowest possible temperature during maximum speed, 1 h running time and 20°C ambient temperature (only with cooling centrifuges)
- 2) Sample temp. rise during maximum speed and 1 h running time (only with centrifuges without cooling)
- 4) 5051 cannot be closed with lid 5053
- 6) with decanting aid











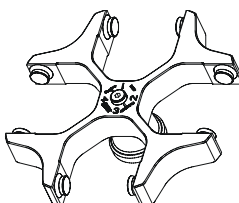





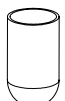
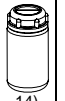
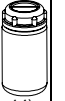

1798	5051 + 5053											
Ausschwingrotor 4-fach / Swing out rotor 4-times 	 											
	5281		5258		5258		5259		5262		5264	
												
2078		0536				0513		0526		0500		
												
Kapazität / capacity	ml	1,5	2,0	10	9 - 10	50	100	9	4 - 5,5	7,5 - 8,2		
Maße / dimensions Ø x L	mm	11 x 38	15 x 102	16 x 92	29 x 115	44 x 100	14 x 100	15 x 75	15 x 92			
Anzahl p. Rotor / number p. rotor		64	44	44	8	4	48	48	48			
Drehzahl / speed	RPM	4000	4000	4000	4000	4000	4000	4000	4000			
RZB / RCF		2826	2755	2755	2826	2755	2773	2773	2773			
Radius / radius	mm	158	154	154	158	154	155	155	155			
 9 (97%)	sec	24										
 9	sec	≥ 17										
Temperatur / temperature	°C ¹⁾	- 8										
Probenerwärmung/Sample temp. rise	K ²⁾	11										

1798	5051 + 5053										
Ausschwingrotor 4-fach / Swing out rotor 4-times 	 										
	5264		5266		5267		5268				
											
											
Kapazität / capacity	ml	4 - 7	30	30	3	1,1 - 1,4	2,6 -2,9	4,9	1,6 - 5		
Maße / dimensions Ø x L	mm	16 x 75	25 x 110	25 x 110	10 x 60	8 x 66	13 x 65	13 x 90	13 x 75		
Anzahl p. Rotor / number p. rotor		48	20	20	80	80	48	48	48		
Drehzahl / speed	RPM	4000	4000	4000	4000	4000	4000	4000	4000		
RZB / RCF		2773	2755	2755	2737	2737	2808	2808	2808		
Radius / radius	mm	155	154	154	153	153	157	157	157		
 9 (97%)	sec	24									
 9	sec	≥ 17									
Temperatur / temperature	°C ¹⁾	- 8									
Probenerwärmung/Sample temp. rise	K ²⁾	11									

1) Tiefste erreichbare Temperatur bei maximaler Drehzahl, 1 h Laufzeit und 20°C Raumtemperatur (nur bei Kühlzentrifuge)
 2) Probenerwärmung bei maximaler Drehzahl und 1 h Laufzeit (nur bei Zentrifuge ohne Kühlung)
 4) 5051 nicht mit Deckel 5053 verschließbar







1) Lowest possible temperature during maximum speed, 1 h running time and 20°C ambient temperature (only with cooling centrifuges)
 2) Sample temp. rise during maximum speed and 1 h running time (only with centrifuges without cooling)
 4) 5051 cannot be closed with lid 5053



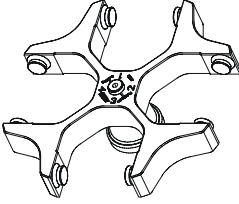



1798	5051 + 5053						
Ausschwingrotor 4-fach / Swing out rotor 4-times  							
							
		 4)					
	Kapazität / capacity ml	4 - 7	15	12			
Maße / dimensions Ø x L mm	16 x 75	17 x 120	17 x 100				
Anzahl p. Rotor / number p. rotor	48	28	28				
Drehzahl / speed RPM	4000	4000	4000				
RZB / RCF	2808	2898	2898				
Radius / radius mm	157	162	162				
 9 (97%) sec	24						
 9 sec	≥ 17						
Temperatur / temperature °C ¹⁾	- 8						
Probenerwärmung/Sample temp. rise K ²⁾	11						

1798	5092 + 5093										
Ausschwingrotor 4-fach / Swing out rotor 4-times  											
	mit Bioabdichtung / with bio-containment 10)										
											
		 14)	 14) 4)								
Kapazität / capacity ml	250	250	290	7	4,5 - 5	4 - 7	15	2,6 - 2,9	9 - 10		
Maße / dimensions Ø x L mm	65 x 115	62 x 122	62 x 137	12 x 100	11 x 92	13 x 100	17 x 100	13 x 65	16 x 92		
Anzahl p. Rotor / number p. rotor	4	4		48	48	48	28	28	28		
Drehzahl / speed RPM	4000	4000	4000	4000	4000	4000	4000	4000	4000		
RZB / RCF	3095	3095	3005	3005	3005	3005	3005	3005	3005		
Radius / radius mm	173	173	168	168	168	168	168	168	168		
 9 (97%) sec	24										
 9 sec	≥ 17										
Temperatur / temperature °C ¹⁾	- 8										
Probenerwärmung/Sample temp. rise K ²⁾	11										

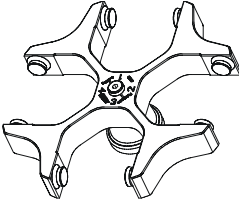
- 1) Tiefste erreichbare Temperatur bei maximaler Drehzahl, 1 h Laufzeit und 20°C Raumtemperatur (nur bei Kühlzentrifuge)
- 2) Probenerwärmung bei maximaler Drehzahl und 1 h Laufzeit (nur bei Zentrifuge ohne Kühlung)
- 4) 5051 nicht mit Deckel 5053 verschließbar
- 10) Nach DIN EN 61010, Teil 2 – 020. Die Hinweise für Bio-Sicherheitssysteme in den Kapiteln "Sicherheitshinweise" und "Pflege und Wartung" beachten.
- 14) Bei Temperaturen über 40 °C und/oder geringer Befüllung der Gefäße können sich diese verformen.









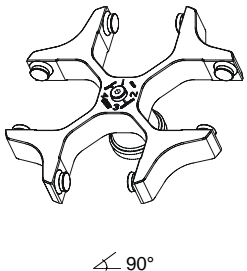

- 1) Lowest possible temperature during maximum speed, 1 h running time and 20°C ambient temperature (only with cooling centrifuges)
- 2) Sample temp. rise during maximum speed and 1 h running time (only with centrifuges without cooling)
- 4) 5051 cannot be closed with lid 5053
- 10) in conformity with DIN EN 61010, part 2 – 020. Observe the notes for bio safety systems in chapters "Notes on safety" and "Maintenance and servicing".
- 14) At temperatures above 40 °C and/or poor filling of the tubes, these can go out of shape.





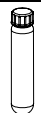

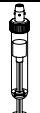
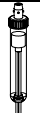

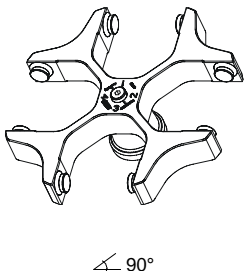

1798		5092 + 5093												
Ausschwingrotor 4-fach / Swing out rotor 4-times  		 +  mit Bioabdichtung / with bio-containment 10)												
		5121				5121-93		5122						
				5) 8		---		0518		0519		---		---
Kapazität / capacity	ml	8,5 - 10	8	10	12	15	4 - 7	25	30	30				
Maße / dimensions	Ø x L mm	16 x 100	16 x 125	15 x 102	17 x 100	17 x 100	16 x 75	24 x 100	25 x 110	25 x 110				
Anzahl p. Rotor / number p. rotor		28		28	28	28	28	16	16	16				
Drehzahl / speed	RPM	4000		4000	4000	4000	4000	4000	4000	4000				
RZB / RCF		3005	3059	3005	3005	3005	3005	2898	2898	2898				
Radius / radius	mm	168	171	168	168	168	168	162	162	162				
 9 (97%)	sec							24						
 9	sec							≥ 17						
Temperatur / temperature	°C ¹⁾							- 8						
Probenerwärmung/Sample temp. rise	K ²⁾							11						

1798		5092 + 5093																	
Ausschwingrotor 4-fach / Swing out rotor 4-times  		 +  mit Bioabdichtung / with bio-containment 10)																	
		5123		5124		5125		5126		5128		5129		5134					
				0513		0521		0526		0523		0501		0553		---		0509	
Kapazität / capacity	ml	50	50	100	100	6	5	4	15	25									
Maße / dimensions	Ø x L mm	29 x 115	34 x 100	44 x 100	40 x 115	12 x 82	13 x 75	12 x 60	17 x 120	25 x 90									
Anzahl p. Rotor / number p. rotor		8	4	4	4	48	48	28	12										
Drehzahl / speed	RPM	4000	4000	4000	4000	4000	4000	4000	4000	4000									
RZB / RCF		3095	2952	2952	2952	3005	3005	3095	2826										
Radius / radius	mm	173	165	165	165	168	168	173	158										
 9 (97%)	sec							24											
 9	sec							≥ 17											
Temperatur / temperature	°C ¹⁾							- 8											
Probenerwärmung/Sample temp. rise	K ²⁾							11											

- 1) Tiefste erreichbare Temperatur bei maximaler Drehzahl, 1 h Laufzeit und 20°C Raumtemperatur (nur bei Kühlzentrifuge)
- 2) Probenerwärmung bei maximaler Drehzahl und 1 h Laufzeit (nur bei Zentrifuge ohne Kühlung)
- 10) Nach DIN EN 61010, Teil 2 – 020. Die Hinweise für Bio-Sicherheitssysteme in den Kapiteln "Sicherheitshinweise" und "Pflege und Wartung" beachten.

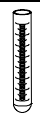
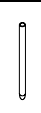

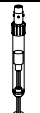







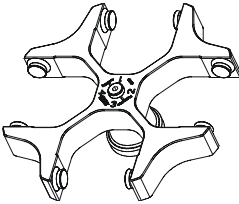



- 1) Lowest possible temperature during maximum speed, 1 h running time and 20°C ambient temperature (only with cooling centrifuges)
- 2) Sample temp. rise during maximum speed and 1 h running time (only with centrifuges without cooling)
- 10) in conformity with DIN EN 61010, part 2 – 020. Observe the notes for bio safety systems in chapters "Notes on safety" and "Maintenance and servicing".







1798	5092 + 5093									
Ausschwingrotor 4-fach / Swing out rotor 4-times  ∠ 90°	 mit Bioabdichtung / with bio-containment 10)									
	5135		5136							
										
	---	2079	0507							
										
Kapazität / capacity	ml	50	10	15	10	4 – 4,5	7,5 – 8,2	9 - 10	10	
Maße / dimensions	∅ x L	mm	29 x 115	17 x 70	17 x 100	16 x 80	15 x 75	15 x 92	16 x 92	15 x 102
Anzahl p. Rotor / number p. rotor		8	32	32	32	32	32	32	32	
Drehzahl / speed	RPM	4000	4000	4000	4000	4000	4000	4000	4000	
RZB / RCF		3023	2952	2952	2952	2952	2952	2952	2952	
Radius / radius	mm	169	165	165	165	165	165	165	165	
9 (97%)	sec	24								
9	sec	≥ 17								
Temperatur / temperature	°C 1)	- 8								
Probenerwärmung/Sample temp. rise	K 2)	11								

1798	5092 + 5093									
Ausschwingrotor 4-fach / Swing out rotor 4-times  ∠ 90°	 mit Bioabdichtung / with bio-containment 10)									
	5136				5137					
										
			0518		0501					
										
Kapazität / capacity	ml	8,5 – 10	4 - 7	15	5	6	1,1 – 1,4	2,7 - 3	2,6 – 2,9	
Maße / dimensions	∅ x L	mm	16 x 100	16 x 75	17 x 100	12 x 75	12 x 82	8 x 66	11 x 66	13 x 65
Anzahl p. Rotor / number p. rotor		32	32	32	32	32	32	32	32	
Drehzahl / speed	RPM	4000	4000	4000	4000	4000	4000	4000	4000	
RZB / RCF		2952	2952	2952	2952	2952	2952	2952	2952	
Radius / radius	mm	165	165	165	165	165	165	165	165	
9 (97%)	sec	24								
9	sec	≥ 17								
Temperatur / temperature	°C 1)	- 8								
Probenerwärmung/Sample temp. rise	K 2)	11								

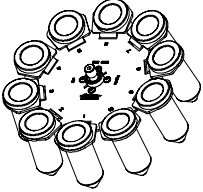
- 1) Tiefste erreichbare Temperatur bei maximaler Drehzahl, 1 h Laufzeit und 20°C Raumtemperatur (nur bei Kühlzentrifuge)
- 2) Probenerwärmung bei maximaler Drehzahl und 1 h Laufzeit (nur bei Zentrifuge ohne Kühlung)
- 10) Nach DIN EN 61010, Teil 2 – 020. Die Hinweise für Bio-Sicherheitssysteme in den Kapiteln "Sicherheitshinweise" und "Pflege und Wartung" beachten.









- 1) Lowest possible temperature during maximum speed, 1 h running time and 20°C ambient temperature (only with cooling centrifuges)
- 2) Sample temp. rise during maximum speed and 1 h running time (only with centrifuges without cooling)
- 10) in conformity with DIN EN 61010, part 2 – 020. Observe the notes for bio safety systems in chapters "Notes on safety" and "Maintenance and servicing".

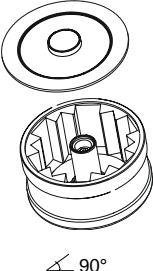
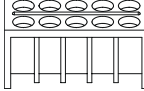
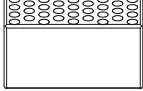
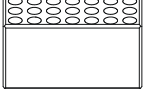





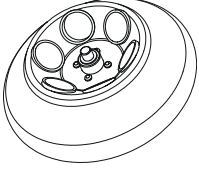

1798		5092 + 5093								
Ausschwingrotor 4-fach / Swing out rotor 4-times  $\angle 90^\circ$		 mit Bioabdichtung / with bio-containment 10)								
		5137					5138			
										
										
Kapazität / capacity	ml	4,9	4,5 - 5	1,6 - 5	4 - 7	5	1,1 - 1,4	2,7-3	2,6 - 2,9	1,6 - 5
Maße / dimensions \varnothing x L	mm	13 x 90	11 x 92	13 x 75	13 x 100	13 x 75	8 x 66	11 x 66	13 x 65	13 x 75
Anzahl p. Rotor / number p. rotor		32	32	32	32	32	48	48	48	48
Drehzahl / speed	RPM	4000	4000	4000	4000	4000	4000	4000	4000	4000
RZB / RCF		2952	2952	2952	2952	2952	2540	2540	2540	2540
Radius / radius	mm	165	165	165	165	165	142	142	142	142
 9 (97%)	sec	24								
 9	sec	≥ 17								
Temperatur / temperature	$^\circ\text{C}^{1)}$	- 8								
Probenerwärmung/Sample temp. rise	K ²⁾	11								

1717												
Ausschwingrotor 10-fach / Swing out rotor 10-times  $\angle 45^\circ$												
		---		1462-A								
												
		0513		0509								
												
Kapazität / capacity	ml	50	15									
Maße / dimensions \varnothing x L	mm	29 x 115	17 x 120									
Anzahl p. Rotor / number p. rotor		10	10									
Drehzahl / speed	RPM	4000	4000									
RZB / RCF		2916	2916									
Radius / radius	mm	163	163									
 9 (97%)	sec	19										
 9	sec	≥ 14										
Temperatur / temperature	$^\circ\text{C}^{1)}$	- 9										
Probenerwärmung/Sample temp. rise	K ²⁾	11										

1) Tiefste erreichbare Temperatur bei maximaler Drehzahl, 1 h Laufzeit und 20°C Raumtemperatur (nur bei Kühlzentrifuge)
 2) Probenerwärmung bei maximaler Drehzahl und 1 h Laufzeit (nur bei Zentrifuge ohne Kühlung)
 10) Nach DIN EN 61010, Teil 2 – 020. Die Hinweise für Bio-Sicherheitssysteme in den Kapiteln "Sicherheitshinweise" und "Pflege und Wartung" beachten.

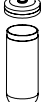

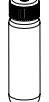
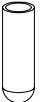
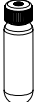





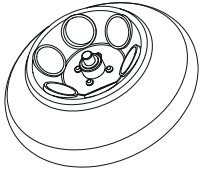

1) Lowest possible temperature during maximum speed, 1 h running time and 20°C ambient temperature (only with cooling centrifuges)
 2) Sample temp. rise during maximum speed and 1 h running time (only with centrifuges without cooling)
 10) in conformity with DIN EN 61010, part 2 – 020. Observe the notes for bio safety systems in chapters "Notes on safety" and "Maintenance and servicing".

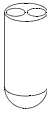





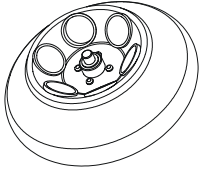
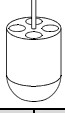

1711		1377		1378		1379	
Topfrotor 6-fach / Pot rotor 6-times  ↙ 90°							
		2078		0536			
							
Kapazität / capacity	ml	1,5	2,0	0,4	0,2	0,5	0,8
Maße / dimensions	∅ x L	11 x 38		6 x 45	6 x 18	8 x 30	8 x 45
Anzahl p. Rotor / number p. rotor		60		192		126	
Drehzahl / speed	RPM	15000		15000		15000	
RZB / RCF	³⁾	18866		18866		18866	
Radius / radius	mm	75		75		75	
 9 (97%)	sec			25			
 9	sec			≥ 23			
Temperatur / temperature	°C ¹⁾			2			
Probenerwärmung/Sample temp. rise	K ²⁾			16			

1720						1454		1446		1447					
Winkelrotor 6-fach / Angle rotor 6-times  ↙ 45° ROTINA 380: 10.000 RPM ROTINA 380R: 11.000 RPM		---		---											
		0547		0549		0539 / 0538		0513		0546		0519		0545	
															
Kapazität / capacity	ml	85		94		50		50		25		30			
Maße / dimensions	∅ x L	38 x 106		38 x 106		29 x 115		29 x 107		24 x 100		26 x 95			
Anzahl p. Rotor / number p. rotor		6		6		6		6		6		6			
Drehzahl / speed	RPM	10000 / 11000	10000 / 11000	10000 / 11000	10000 / 11000	10000 / 11000	10000 / 11000		10000 / 11000	10000 / 11000	10000 / 11000	10000 / 11000	10000 / 11000		
RZB / RCF	³⁾	13528 / 16369	13528 / 16369	13528 / 16369	12745 / 15422	12745 / 15422	12969 / 15692		12410 / 15016	12410 / 15016	12410 / 15016	12410 / 15016	12410 / 15016		
Radius / radius	mm	121		114		114		116		111		111			
 9 (97%)	sec					39 / 45									
 9	sec					36 / 44									
Temperatur / temperature	°C ¹⁾					1									
Probenerwärmung/Sample temp. rise	K ²⁾					10									

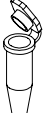
1) Tiefste erreichbare Temperatur bei maximaler Drehzahl, 1 h Laufzeit und 20°C Raumtemperatur (nur bei Kühlzentrifuge)
 2) Probenerwärmung bei maximaler Drehzahl und 1 Stunde Laufzeit (nur bei Zentrifuge ohne Kühlung)
 3) Zentrifugiergefäße aus Glas nur belastbar bis RZB 4000







1) Lowest possible temperature during maximum speed, 1 h running time and 20°C ambient temperature (only with cooling centrifuges)
 2) Sample temp. rise during maximum speed and 1 hour running time (only with centrifuges without cooling)
 3) Centrifuge containers of glass will not stand RCF values exceeding 4000



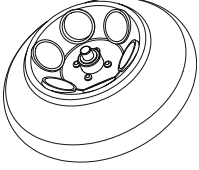







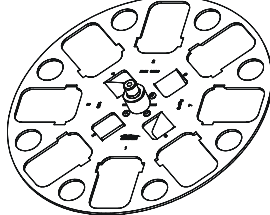



1720						
Winkelrotor 6-fach / Angle rotor 6-times  $\angle 45^\circ$ ROTINA 380: 10.000 RPM ROTINA 380R: 11.000 RPM						
		1466		1451		1448
						
		0509	0507		0518	
						
Kapazität / capacity	ml	15	15	8,5 – 10	7,5 - 8,2; 9 - 10	10
Maße / dimensions \varnothing x L	mm	17 x 120	17 x 100	16 x 100	15 / 16 x 92	16 x 80
Anzahl p. Rotor / number p. rotor		6	6	6	6	12
Drehzahl / speed	RPM	10000 / 11000	10000 / 11000	10000 / 11000	10000 / 11000	10000 / 11000
RZB / RCF	³⁾	13081 / 15828	12745 / 15422	12745 / 15422	12745 / 15422	12410 / 15016
Radius / radius	mm	117	114	114	114	111
 9 (97%)	sec	39 / 45				
 9	sec	36 / 44				
Temperatur / temperature	$^\circ\text{C}$ ¹⁾	1				
Probenerwärmung/Sample temp. rise	K ²⁾	10				

1720						
Winkelrotor 6-fach / Angle rotor 6-times  $\angle 45^\circ$ ROTINA 380: 10.000 RPM ROTINA 380R: 11.000 RPM						
			1449		1463	
						
		2078	0536		0521	0548
						
Kapazität / capacity	ml	1,5	2,0	3	50	75
Maße / dimensions \varnothing x L	mm	11 x 38		10 x 60	34 x 100	35 x 105
Anzahl p. Rotor / number p. rotor		24		24	6	6
Drehzahl / speed	RPM	10000 / 11000	10000 / 11000	10000	11000	10000
RZB / RCF	³⁾	12969 / 15692	12969 / 15692	12969	15692	13304
Radius / radius	mm	116	116	119	119	119
 9 (97%)	sec	39 / 45				
 9	sec	36 / 44				
Temperatur / temperature	$^\circ\text{C}$ ¹⁾	1				
Probenerwärmung/Sample temp. rise	K ²⁾	10				

- 1) Tiefste erreichbare Temperatur bei maximaler Drehzahl, 1 h Laufzeit und 20°C Raumtemperatur (nur bei Kühlzentrifuge)
- 2) Probenerwärmung bei maximaler Drehzahl und 1 Stunde Laufzeit (nur bei Zentrifuge ohne Kühlung)
- 3) Zentrifugiergefäße aus Glas nur belastbar bis RZB 4000











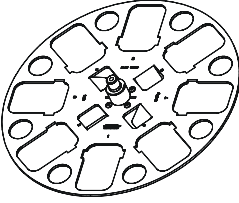

- 1) Lowest possible temperature during maximum speed, 1 h running time and 20°C ambient temperature (only with cooling centrifuges)
- 2) Sample temp. rise during maximum speed and 1 hour running time (only with centrifuges without cooling)
- 3) Centrifuge containers of glass will not stand RCF values exceeding 4000









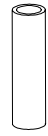

1720					
Winkelrotor 6-fach / Angle rotor 6-times  $\angle 45^\circ$ ROTINA 380: 10.000 RPM ROTINA 380R: 11.000 RPM		SK 63.98			
			0501		
					
Kapazität / capacity	ml	5	6	1,6 – 5	2,6 – 2,9
Maße / dimensions $\varnothing \times L$	mm	12/13 x 75	12 x 82	13 x 75	13 x 65
Anzahl p. Rotor / number p. rotor		12	12	12	12
Drehzahl / speed	RPM	10000 / 11000	10000 / 11000	10000 / 11000	10000 / 11000
RZB / RCF	³⁾	11963 / 14475	11963 / 14475	11963 / 14475	11963 / 14475
Radius / radius	mm	107	107	107	107
 9 (97%)	sec	39 / 45			
 9	sec	36 / 44			
Temperatur / temperature	$^\circ\text{C}$ ¹⁾	1			
Probenerwärmung/Sample temp. rise	K ²⁾	10			

1721		1467				1468			
Winkelrotor 8-fach / Angle rotor 8-times  $\angle 45^\circ$									
		0716				E2109		E2110	
									
		0507	---	0518	---	0509	---	0513	0546
									
Kapazität / capacity	ml	15	12	15	9 - 10	15	50	50	50
Maße / dimensions $\varnothing \times L$	mm	17 x 100	17 x 100	17 x 100	16 x 92	17 x 120	29 x 115	29 x 115	29 x 107
Anzahl p. Rotor / number p. rotor		32	32	32	32	32	8	8	8
Drehzahl / speed	RPM	4500	4500	4500	4500	4500	4500	4500	4500
RZB / RCF		3215	3215	3215	3215	3283	3147	3147	3147
Radius / radius	mm	142	142	142	142	145	139	139	139
 9 (97%)	sec	17							
 9	sec	≥ 14							
Temperatur / temperature	$^\circ\text{C}$ ¹⁾	- 11							
Probenerwärmung/Sample temp. rise	K ²⁾	10							

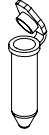
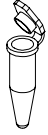
- 1) Tiefste erreichbare Temperatur bei maximaler Drehzahl, 1 h Laufzeit und 20°C Raumtemperatur (nur bei Kühlzentrifuge)
- 2) Probenerwärmung bei maximaler Drehzahl und 1 Stunde Laufzeit (nur bei Zentrifuge ohne Kühlung)
- 3) Zentrifugiergefäße aus Glas nur belastbar bis RZB 4000









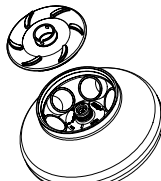

- 1) Lowest possible temperature during maximum speed, 1 h running time and 20°C ambient temperature (only with cooling centrifuges)
- 2) Sample temp. rise during maximum speed and 1 hour running time (only with centrifuges without cooling)
- 3) Centrifuge containers of glass will not stand RCF values exceeding 4000









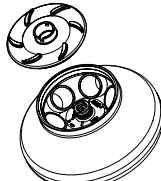

1721		1467							
Winkelrotor 8-fach / Angle rotor 8-times  45°									
		1054-A							
									
		0701	0553						
									
Kapazität / capacity	ml	4	5	1,1 – 1,4	2,7 - 3	2,6 – 2,9	1,6 - 5	5	
Maße / dimensions	∅ x L mm	12 x 60	12 x 75	8 x 66	11 x 66	13 x 65	13 x 75	13 x 75	
Anzahl p. Rotor / number p. rotor		32	32	32	32	32	32	32	
Drehzahl / speed	RPM	4500	4500	4500	4500	4500	4500	4500	
RZB / RCF		2694	2762	2762	2762	2762	2762	2762	
Radius / radius	mm	119	122	122	122	122	122	122	
 9 (97%)	sec								17
 9	sec								≥ 14
Temperatur / temperature	°C ¹⁾								- 11
Probenerwärmung/Sample temp. rise	K ²⁾								10

1789-A									
Winkelrotor 30-fach / Angle rotor 30-times  45° mit Bioabdichtung / with bio-containment 10)		--- 2031 13) 2023 2024							
		  							
		0536 2078 --- --- --- ---							
									
Kapazität / capacity	ml	2,0	1,5	0,8	0,5	0,4	0,2		
Maße / dimensions	∅ x L mm	11 x 38	11 x 38	8 x 45	8 x 30	6 x 45	6 x 18		
Anzahl p. Rotor / number p. rotor		30	30	30	30	30	30		
Drehzahl / speed	RPM	15000	15000	15000	15000	15000	15000		
RZB / RCF	³⁾	24400	24400	24400	24400	24400	24400		
Radius / radius	mm	97	97	97	97	97	97		
 9 (97%)	sec								23
 9	sec								≥ 20
Temperatur / temperature	°C ¹⁾								4
Probenerwärmung/Sample temp. rise	K ²⁾								19

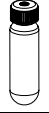
- 1) Tiefste erreichbare Temperatur bei maximaler Drehzahl, 1 h Laufzeit und 20°C Raumtemperatur (nur bei Kühlzentrifuge)
- 2) Probenerwärmung bei maximaler Drehzahl und 1 Stunde Laufzeit (nur bei Zentrifuge ohne Kühlung)
- 3) Zentrifugiergefäße aus Glas nur belastbar bis RZB 4000
- 10) Nach DIN EN 61010, Teil 2 – 020. Die Hinweise für Bio-Sicherheitssysteme in den Kapiteln "Sicherheitshinweise" und "Pflege und Wartung" beachten.
- 13) bei hochtouriger Zentrifugation empfohlen









- 1) Lowest possible temperature during maximum speed, 1 h running time and 20°C ambient temperature (only with cooling centrifuges)
- 2) Sample temp. rise during maximum speed and 1 hour running time (only with centrifuges without cooling)
- 3) Centrifuge containers of glass will not stand RCF values exceeding 4000
- 10) in conformity with DIN EN 61010, part 2 – 020. Observe the notes for bio safety systems in chapters "Notes on safety" and "Maintenance and servicing".
- 13) recommended for high-speed centrifugation

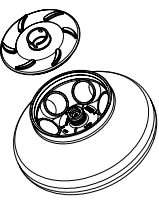



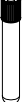



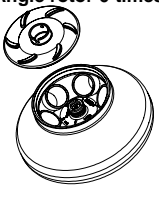

1792						
Winkelrotor 6-fach / Angle rotor 6-times  45° mit Bioabdichtung / with bio-containment 10) ROTINA 380: 10.000 RPM ROTINA 380R: 11.000 RPM		---		1454	1446	
		---				
		0539 / 0538	0549	0547	0513	0546
		 + 				
Kapazität / capacity	ml	94	85	85	50	50
Maße / dimensions	Ø x L	38 x 106		38 x 106	29 x 115	29 x 107
Anzahl p. Rotor / number p. rotor		6		6	6	6
Drehzahl / speed	RPM	10000 / 11000	10000 / 11000	10000 / 11000	10000 / 11000	10000 / 11000
RZB / RCF	³⁾	13640 / 16504	12522 / 15151	13640 / 16504	13304 / 16098	13081 / 15828
Radius / radius	mm	122		122	119	117
 9 (97%)	sec					40 / 48
 9	sec					37 / 44
Temperatur / temperature	°C ¹⁾					4
Probenerwärmung/Sample temp. rise	K ²⁾					16

1792						
Winkelrotor 6-fach / Angle rotor 6-times  45° mit Bioabdichtung / with bio-containment 10) ROTINA 380: 10.000 RPM ROTINA 380R: 11.000 RPM		1447		1466	1451	
						
		0519	0545	0509	0507	
						
Kapazität / capacity	ml	25	30	15	15	7,5 – 8,2
Maße / dimensions	Ø x L	24 x 100	26 x 95	17 x 120	17 x 100	15 x 92
Anzahl p. Rotor / number p. rotor		6		6	6	6
Drehzahl / speed	RPM	10000 / 11000	10000 / 11000	10000 / 11000	10000 / 1000	10000 / 11000
RZB / RCF	³⁾	12522 / 15151	12522 / 15151	13081 / 15828	12857 / 15557	12857 / 15557
Radius / radius	mm	112		117	115	115
 9 (97%)	sec					40 / 48
 9	sec					37 / 44
Temperatur / temperature	°C ¹⁾					4
Probenerwärmung/Sample temp. rise	K ²⁾					16

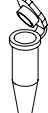
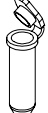
- 1) Tiefste erreichbare Temperatur bei maximaler Drehzahl, 1 h Laufzeit und 20°C Raumtemperatur (nur bei Kühlzentrifuge)
- 2) Probenerwärmung bei maximaler Drehzahl und 1 Stunde Laufzeit (nur bei Zentrifuge ohne Kühlung)
- 3) Zentrifugiergefäße aus Glas nur belastbar bis RZB 4000
- 10) Nach DIN EN 61010, Teil 2 – 020. Die Hinweise für Bio-Sicherheitssysteme in den Kapiteln "Sicherheitshinweise" und "Pflege und Wartung" beachten.









- 1) Lowest possible temperature during maximum speed, 1 h running time and 20°C ambient temperature (only with cooling centrifuges)
- 2) Sample temp. rise during maximum speed and 1 hour running time (only with centrifuges without cooling)
- 3) Centrifuge containers of glass will not stand RCF values exceeding 4000 in conformity with DIN EN 61010, part 2 – 020. Observe the notes for bio safety systems in chapters "Notes on safety" and "Maintenance and servicing".

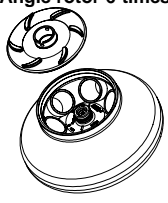









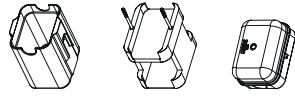
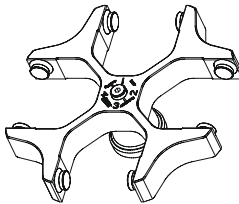

<p>1792</p> <p>Winkelrotor 6-fach / Angle rotor 6-times</p>  <p>45°</p> <p>mit Bioabdichtung / with bio-containment 10)</p> <p>ROTINA 380: 10.000 RPM ROTINA 380R: 11.000 RPM</p>	1451					
						
						
						
	Kapazität / capacity	ml	9 - 10	10	8,5 - 10	15
	Maße / dimensions Ø x L	mm	16 x 92	15 x 102	16 x 100	17 x 100
	Anzahl p. Rotor / number p. rotor		6	6	6	6
	Drehzahl / speed	RPM	10000 / 11000	10000 / 11000	10000 / 11000	10000 / 11000
	RZB / RCF	³⁾	12857 / 15557	12857 / 15557	12857 / 15557	12857 / 15557
	Radius / radius	mm	115	115	115	115
 9 (97%)	sec	40 / 48				
 9	sec	37 / 44				
Temperatur / temperature	°C ¹⁾	4				
Probenerwärmung/Sample temp. rise	K ²⁾	16				

<p>1792</p> <p>Winkelrotor 6-fach / Angle rotor 6-times</p>  <p>45°</p> <p>mit Bioabdichtung / with bio-containment 10)</p> <p>ROTINA 380: 10.000 RPM ROTINA 380R: 11.000 RPM</p>	1448		1449		1463			
								
								
	Kapazität / capacity	ml	10	1,5	2,0	3	50	50
	Maße / dimensions Ø x L	mm	16 x 80	11 x 38	11 x 38	10 x 60	34 x 100	35 x 105
	Anzahl p. Red./number p. adapter		2	4			1	1
	Anzahl p. Rotor / number p. rotor		12	24			6	6
	Drehzahl / speed	RPM	10000 / 11000	10000 / 11000			10000 / 11000	10000 / 11000
	RZB / RCF	³⁾	12857 / 15557	13081 / 15828			13640 / 16504	13640 / 16504
	Radius / radius	mm	115	117			122	122
 9 (97%)	sec	40 / 48						
 9	sec	37 / 44						
Temperatur / temperature	°C ¹⁾	4						
Probenerwärmung/Sample temp. rise	K ²⁾	16						

- 1) Tiefste erreichbare Temperatur bei maximaler Drehzahl, 1 h Laufzeit und 20°C Raumtemperatur (nur bei Kühlzentrifuge)
- 2) Probenerwärmung bei maximaler Drehzahl und 1 Stunde Laufzeit (nur bei Zentrifuge ohne Kühlung)
- 3) Zentrifugiergefäße aus Glas nur belastbar bis RZB 4000
- 10) Nach DIN EN 61010, Teil 2 – 020. Die Hinweise für Bio-Sicherheitssysteme in den Kapiteln "Sicherheitshinweise" und "Pflege und Wartung" beachten.











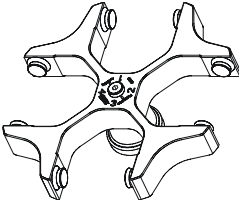

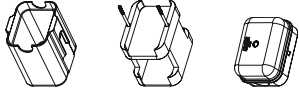
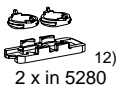
- 1) Lowest possible temperature during maximum speed, 1 h running time and 20°C ambient temperature (only with cooling centrifuges)
- 2) Sample temp. rise during maximum speed and 1 hour running time (only with centrifuges without cooling)
- 3) Centrifuge containers of glass will not stand RCF values exceeding 4000 in conformity with DIN EN 61010, part 2 – 020. Observe the notes for bio safety systems in chapters "Notes on safety" and "Maintenance and servicing".











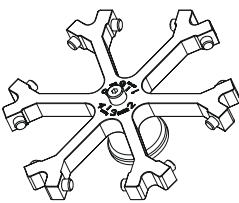

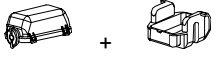

1792						
Winkelrotor 6-fach / Angle rotor 6-times						
						
45°						
mit Bioabdichtung / with bio-containment 10)						
ROTINA 380: 10.000 RPM ROTINA 380R: 11.000 RPM						
		SK 63.98				
		0553	---	0501		
						
Kapazität / capacity	ml	5		6	1,6 – 5	2,6 – 2,9
Maße / dimensions	∅ x L mm	12 x 75	13 x 75	12 x 82	13 x 75	13 x 65
Anzahl p. Rotor / number p. rotor		12		12	12	12
Drehzahl / speed	RPM	10000 / 11000		10000 / 11000	10000 / 11000	10000 / 11000
RZB / RCF	³⁾	12186 / 14745		12186 / 14745	12186 / 14745	12186 / 14745
Radius / radius	mm	109		109	109	109
 9 (97%)	sec	40 / 48				
 9	sec	37 / 44				
Temperatur / temperature	°C ¹⁾	4				
Probenerwärmung/Sample temp. rise	K ²⁾	16				

1798		5051 + 5280 5053							
Ausschwingrotor4-fach / Swing out rotor 4-times									
									
90°									
		1662				1670			
		 2 x in 5280				 ¹²⁾ 2 x in 5280			
		1663	1664	1665	1666	1667	1668	1663	1664
									
Kapazität / capacity	ml	1	2	4	8	3 x 2	4 x 1	1	2
Maße / dimensions	∅ / A mm ²	6,2 / 30	8,7 / 60	12,4 / 120	17,5 / 240	8,7 / 60	6,2 / 30	6,2 / 30	8,7 x 60
Anzahl p. Rotor / number p. rotor		8	8	8	8	8	8	8	8
Filterkarten / filter cards		1675	1675	1675	1676	1677	1678	1692	1692
Drehzahl / speed	RPM	4000	4000	4000	4000	4000	4000	4000	4000
RZB / RCF		1735/2737	1735/2737	1735/2737	1735/2737	1735/2737	1735/2737	1735/2737	1735/2737
Radius / radius	mm	97 / 153	97 / 153	97 / 153	97 / 153	97 / 153	97 / 153	97 / 153	97 / 153
 9 (97%)	sec	24							
 9	sec	≥ 17							
Temperatur / temperature	°C ¹⁾	- 8							
Probenerwärmung/Sample temp. rise	K ²⁾	11							

- 1) Tiefste erreichbare Temperatur bei maximaler Drehzahl, 1 h Laufzeit und 20°C Raumtemperatur (nur bei Kühlzentrifuge)
- 2) Probenerwärmung bei maximaler Drehzahl und 1 Stunde Laufzeit (nur bei Zentrifuge ohne Kühlung)
- 3) Zentrifugiergefäße aus Glas nur belastbar bis RZB 4000
- 10) Nach DIN EN 61010, Teil 2 – 020. Die Hinweise für Bio-Sicherheitssysteme in den Kapiteln "Sicherheitshinweise" und "Pflege und Wartung" beachten.











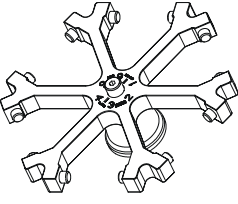
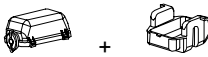

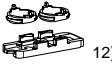
- 1) Lowest possible temperature during maximum speed, 1 h running time and 20°C ambient temperature (only with cooling centrifuges)
- 2) Sample temp. rise during maximum speed and 1 hour running time (only with centrifuges without cooling)
- 3) Centrifuge containers of glass will not stand RCF values exceeding 4000 in conformity with DIN EN 61010, part 2 – 020. Observe the notes for bio safety systems in chapters "Notes on safety" and "Maintenance and servicing".







1798	5051 + 5280 5053							
Ausschwingrotor 4-fach / Swing out rotor 4-times  								
	1670  2 x in 5280 ¹²⁾				1470 			
	1665	1666	1667	1668	1471	1475		
								
Kapazität / capacity ml	4	8	3 x 2	4 x 1	1 x 8	2 x 8		
Maße / dimensions Ø / A mm ²	12,4 x 120	17,5 x 240	8,7 / 60	6,2 / 30	17,5 / 240	17,5 / 240		
Anzahl p. Rotor / number p. rotor	8	8	8	8	8	8		
Filterkarten / filter cards	1692	1691	1694	1693	---	---		
Drehzahl / speed RPM	4000	4000	4000	4000	4000	4000		
RZB / RCF	1735/2737	1735/2737	1735/2737	1735/2737	1664/2665	1664/2665		
Radius / radius mm	97 / 153	97 / 153	97 / 153	97 / 153	93 / 149	93 / 149		
 9 (97%) sec	24							
 9 sec	≥ 17							
Temperatur / temperature °C ¹⁾	- 8							
Probenerwärmung/Sample temp. rise K ²⁾	11							

1726	1661 1660									
Ausschwingrotor 6-fach / Swing out rotor 6-times  										
	1662 						1670  ¹²⁾			
	1663	1664	1665	1666	1667	1668	1663	1664		
										
Kapazität / capacity ml	1	2	4	8	3 x 2	4 x 1	1	2		
Maße / dimensions Ø / A mm ²	6,2 / 30	8,7 / 60	12,4 / 120	17,5 / 240	8,7 / 60	6,2 / 30	6,2 / 30	8,7 / 60		
Anzahl p. Rotor / number p. rotor	6	6	6	6	6	6	6	6		
Filterkarten / filter cards	1675	1675	1675	1676	1677	1678	1692	1692		
Drehzahl / speed RPM	4000	4000	4000	4000	4000	4000	4000	4000		
RZB / RCF	2003	2003	2003	2003	2003	2003	2003	2003		
Radius / radius mm	112	112	112	112	112	112	112	112		
 9 (97%) sec	19									
 9 sec	≥ 18									
Temperatur / temperature °C ¹⁾	- 6									
Probenerwärmung/Sample temp. rise K ²⁾	9									

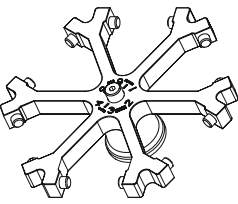
- 1) Tiefste erreichbare Temperatur bei maximaler Drehzahl, 1 h Laufzeit und 20°C Raumtemperatur (nur bei Kühlzentrifuge)
- 2) Probenerwärmung bei maximaler Drehzahl und 1 Stunde Laufzeit (nur bei Zentrifuge ohne Kühlung)
- 3) Zentrifugiergefäße aus Glas nur belastbar bis RZB 4000
- 10) Nach DIN EN 61010, Teil 2 – 020. Die Hinweise für Bio-Sicherheitssysteme in den Kapiteln "Sicherheitshinweise" und "Pflege und Wartung" beachten.











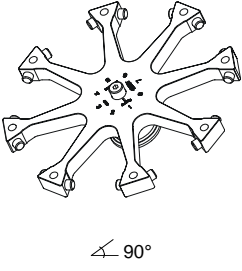
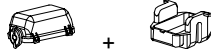

- 1) Lowest possible temperature during maximum speed, 1 h running time and 20°C ambient temperature (only with cooling centrifuges)
- 2) Sample temp. rise during maximum speed and 1 hour running time (only with centrifuges without cooling)
- 3) Centrifuge containers of glass will not stand RCF values exceeding 4000
- 10) in conformity with DIN EN 61010, part 2 – 020. Observe the notes for bio safety systems in chapters "Notes on safety" and "Maintenance and servicing".











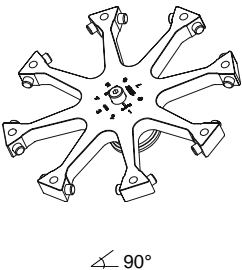
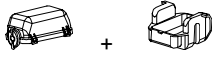

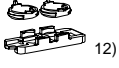
1726		1661 1660		1660		1680			
Ausschwingrotor 6-fach / Swing out rotor 6-times  ∠ 90°									
								1670	
				 12)					
				1665	1666	1667	1668	1671	1672
									
Kapazität / capacity	ml	4	8	3 x 2	4 x 1	Objekträger/ object slide	[1] 0,5	[1] 0,5	[1] 0,5
Maße / dimensions Ø / A	mm ²	12,4 / 120	17,5 / 240	8,7 / 60	6,2 / 30	26 / 76	6,2 / 30	8,7 / 60	12,4 / 120
Anzahl p. Rotor / number p. rotor		6	6	6	6	36	6	6	6
Filterkarten / filter cards		1692	1691	1694	1693	---	[1] 1696	[1] 1696	[1] 1696
Drehzahl / speed	RPM	4000	4000	4000	4000	4000	4000	4000	4000
RZB / RCF		2003	2003	2003	2003	1932	1825	1825	1825
Radius / radius	mm	112	112	112	112	108	102	102	102
 9 (97%)	sec	19							
 9	sec	≥ 18							
Temperatur / temperature	°C ¹⁾	- 6							
Probenerwärmung/Sample temp. rise	K ²⁾	9							

1726		1661 1660									
Ausschwingrotor 6-fach / Swing out rotor 6-times  ∠ 90°											
				1470							
											
				1471	1475						
											
Kapazität / capacity	ml	1 x 8	2 x 8								
Maße / dimensions Ø / A	mm ²	17,5 / 240	17,5 / 240								
Anzahl p. Rotor / number p. rotor		6	6								
Filterkarten / filter cards		---	---								
Drehzahl / speed	RPM	4000	4000								
RZB / RCF		1914	1914								
Radius / radius	mm	107	107								
 9 (97%)	sec	19									
 9	sec	≥ 18									
Temperatur / temperature	°C ¹⁾	- 6									
Probenerwärmung/Sample temp. rise	K ²⁾	9									

1) Tiefste erreichbare Temperatur bei maximaler Drehzahl, 1 h Laufzeit und 20°C Raumtemperatur (nur bei Kühlzentrifuge)
 2) Probenerwärmung bei maximaler Drehzahl und 1 h Laufzeit (nur bei Zentrifuge ohne Kühlung)
 12) Objekträger nur belastbar bis RZB 1100
 [1] Einschritt-Methode







1) Lowest possible temperature during maximum speed, 1 h running time and 20°C ambient temperature (only with cooling centrifuges)
 2) Sample temp. rise during maximum speed and 1 h running time (only with centrifuges without cooling)
 12) Object slide will not stand RCF values exceeding 1100
 [1] One-step method

1748	1661 1660							
Ausschwingrotor 8-fach / Swing out rotor 8-times 								
							 12)	
								
	Kapazität / capacity ml	1	2	4	8	3 x 2	4 x 1	1
Maße / dimensions Ø / A mm ²	6,2 / 30	8,7 / 60	12,4 / 120	17,5 / 240	8,7 / 60	6,2 / 30	6,2 / 30	8,7 / 60
Anzahl p. Rotor / number p. rotor	8	8	8	8	8	8	8	8
Filterkarten / filter cards	1675	1675	1675	1676	1677	1678	1692	1692
Drehzahl / speed RPM	4000	4000	4000	4000	4000	4000	4000	4000
RZB / RCF	2415	2415	2415	2415	2415	2415	2415	2415
Radius / radius mm	135	135	135	135	135	135	135	135
 9 (97%) sec							18	
 9 sec							≥ 14	
Temperatur / temperature °C ¹⁾							- 10	
Probenerwärmung/Sample temp. rise K ²⁾							9	

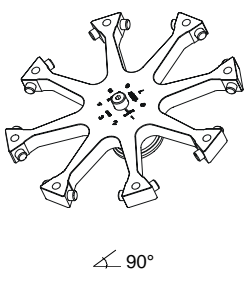
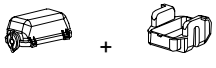
1748	1661	1660	1660	1680				
Ausschwingrotor 8-fach / Swing out rotor 8-times 								
	 12)							
								
	Kapazität / capacity ml	4	8	3 x 2	4 x 1	Objektträger/ object slide	[1] 0,5	[1] 0,5
Maße / dimensions Ø / A mm ²	12,4 / 120	17,5 / 240	8,7 / 60	6,2 / 30	26 / 76	6,2 / 30	8,7 / 60	12,4 / 120
Anzahl p. Rotor / number p. rotor	8	8	8	8	48	8	8	8
Filterkarten / filter cards	1692	1691	1694	1693	---	[1] 1696	[1] 1696	[1] 1696
Drehzahl / speed RPM	4000	4000	4000	4000	4000	4000	4000	4000
RZB / RCF	2415	2415	2415	2415	2272	2218	2218	2218
Radius / radius mm	135	135	135	135	127	124	124	124
 9 (97%) sec							18	
 9 sec							≥ 14	
Temperatur / temperature °C ¹⁾							- 10	
Probenerwärmung/Sample temp. rise K ²⁾							9	

1) Tiefste erreichbare Temperatur bei maximaler Drehzahl, 1 h Laufzeit und 20°C Raumtemperatur (nur bei Kühlzentrifuge)
 2) Probenerwärmung bei maximaler Drehzahl und 1 h Laufzeit (nur bei Zentrifuge ohne Kühlung)
 12) Objektträger nur belastbar bis RZB 1100
 [1] Einschritt-Methode











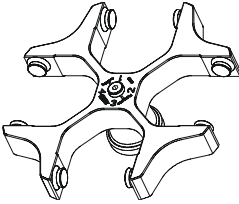











1) Lowest possible temperature during maximum speed, 1 h running time and 20°C ambient temperature (only with cooling centrifuges)
 2) Sample temp. rise during maximum speed and 1 h running time (only with centrifuges without cooling)
 12) Object slide will not stand RCF values exceeding 1100
 [1] One-step method











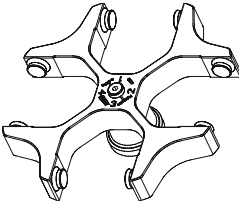























1748		1661	1660					
Ausschwingrotor 8-fach / Swing out rotor 8-times  ∠ 90°								
		1470						
								
		1471	1475					
								
Kapazität / capacity	ml	1 x 8	2 x 8					
Maße / dimensions	∅ / A mm ²	17,5 / 240	17,5 / 240					
Anzahl p. Rotor / number p. rotor		8	8					
Filterkarten / filter cards		---	---					
Drehzahl / speed	RPM	4000	4000					
RZB / RCF		2325	2325					
Radius / radius	mm	130	130					
 9 (97%)	sec	18						
 9	sec	≥ 14						
Temperatur / temperature	°C ¹⁾	- 10						
Probenerwärmung/Sample temp. rise	K ²⁾	9						

1) Tiefste erreichbare Temperatur bei maximaler Drehzahl, 1 h Laufzeit und 20°C Raumtemperatur (nur bei Kühlzentrifuge)
 2) Probenerwärmung bei maximaler Drehzahl und 1 h Laufzeit (nur bei Zentrifuge ohne Kühlung)
 12) Objektträger nur belastbar bis RZB 1100
 [1] Einschritt-Methode

1) Lowest possible temperature during maximum speed, 1 h running time and 20°C ambient temperature (only with cooling centrifuges)
 2) Sample temp. rise during maximum speed and 1 h running time (only with centrifuges without cooling)
 12) Object slide will not stand RCF values exceeding 1100
 [1] One-step method









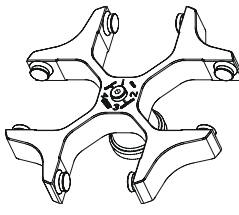

41.1.2 ROTINA 380, Typ / type 1701-30







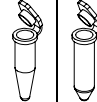
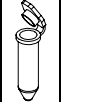
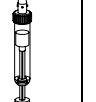
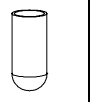
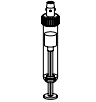
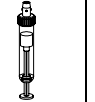
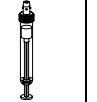



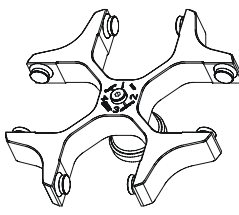

<p>1798</p> <p>Ausschwingrotor 4-fach / Swing out rotor 4-times</p>  <p>90°</p>	5051 + 5053		 						
	5227			5242	5243	5243	5247		
									
	0553	0501							
									
	Kapazität / capacity ml	5	6	2,7 – 3	4,5 – 5	25	50 ⁴⁾	50	7
	Maße / dimensions Ø x L mm	12 x 75	12 x 82	11 x 66	11 x 92	24 x 100	29 x 115	34 x 100	12 x 100
	Anzahl p. Rotor / number p. rotor	80	80	80	80	20	8	8	80
	Drehzahl / speed RPM	4000	4000	4000	4000	4000	4000	4000	4000
	RZB / RCF	2773	2773	2773	2773	2755	2755	2755	2755
Radius / radius mm	155	155	155	155	154	154	154	154	
 9 (97%) sec	24								
 9 sec	≥ 17								
Temperatur / temperature °C ¹⁾	- 8								
Probenerwärmung/Sample temp. Rise K ²⁾	11								

<p>1798</p> <p>Ausschwingrotor 4-fach / Swing out rotor 4-times</p>  <p>90°</p>	5051 + 5053		 							
	5247-91	5248		5248-91	5249	5257				
										
										
	0578	0507	----	0518	0507	0518	0523	2078	0536	
										
										
	Kapazität / capacity ml	7	15	8,5 - 10	15	15	15	100	1,5	2,0
	Maße / dimensions Ø x L mm	12 x 100	17 x 100	16 x 100	17 x 100	17 x 100	17 x 100	40 x 115	11 x 38	
	Anzahl p. Rotor / number p. rotor	80	48	48	48	48	48	4	160	
Drehzahl / speed RPM	4000	4000	4000	4000	4000	4000	4000	4000		
RZB / RCF	2755	2755	2755	2755	2755	2755	2755	1950/2826		
Radius / radius mm	154	154	154	154	154	154	154	109/158		
 9 (97%) sec	24									
 9 sec	≥ 17									
Temperatur / temperature °C ¹⁾	- 8									
Probenerwärmung/Sample temp. rise K ²⁾	11									

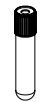
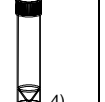
1) Tiefste erreichbare Temperatur bei maximaler Drehzahl, 1 h Laufzeit und 20°C Raumtemperatur (nur bei Kühlzentrifuge)
 2) Probenerwärmung bei maximaler Drehzahl und 1 h Laufzeit (nur bei Zentrifuge ohne Kühlung)
 4) 5051 nicht mit Deckel 5053 verschließbar
 6) mit Dekantierhilfe

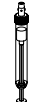

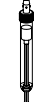
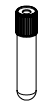







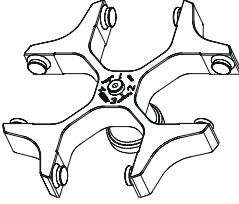

1) Lowest possible temperature during maximum speed, 1 h running time and 20°C ambient temperature (only with cooling centrifuges)
 2) Sample temp. rise during maximum speed and 1 h running time (only with centrifuges without cooling)
 4) 5051 cannot be closed with lid 5053
 6) with decanting aid











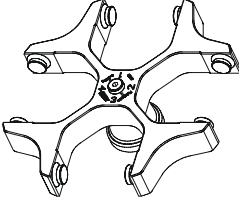





1798		5051 + 5053											
Ausschwingrotor 4-fach / Swing out rotor 4-times  90°		 											
		5281		5258		5258		5259		5262		5264	
													
2078		0536				0513		0526		0500			
													
Kapazität / capacity	ml	1,5	2,0	10	9 - 10	50	100	9	4 - 5,5	7,5 - 8,2			
Maße / dimensions	Ø x L	mm	11 x 38	15 x 102	16 x 92	29 x 115	44 x 100	14 x 100	15 x 75	15 x 92			
Anzahl p. Rotor / number p. rotor		64	44	44	8	4	48	48	48	48			
Drehzahl / speed	RPM	4000	4000	4000	4000	4000	4000	4000	4000	4000			
RZB / RCF		2826	2755	2755	2826	2755	2755	2773	2773	2773			
Radius / radius	mm	158	154	154	158	154	155	155	155	155			
 9 (97%)	sec							24					
 9	sec							≥ 17					
Temperatur / temperature	°C ¹⁾							- 8					
Probenerwärmung/Sample temp. rise	K ²⁾							11					

1798		5051 + 5053											
Ausschwingrotor 4-fach / Swing out rotor 4-times  90°		 											
		5264		5266		5267		5268					
													
													
Kapazität / capacity	ml	4 - 7	30	30	3	1,1 - 1,4	2,6 - 2,9	4,9	1,6 - 5				
Maße / dimensions	Ø x L	mm	16 x 75	25 x 110	25 x 110	10 x 60	8 x 66	13 x 65	13 x 90	13 x 75			
Anzahl p. Rotor / number p. rotor		48	20	20	80	80	48	48	48	48			
Drehzahl / speed	RPM	4000	4000	4000	4000	4000	4000	4000	4000	4000			
RZB / RCF		2773	2755	2755	2737	2737	2808	2808	2808	2808			
Radius / radius	mm	155	154	154	153	153	157	157	157	157			
 9 (97%)	sec							24					
 9	sec							≥ 17					
Temperatur / temperature	°C ¹⁾							- 8					
Probenerwärmung/Sample temp. rise	K ²⁾							11					

- 1) Tiefste erreichbare Temperatur bei maximaler Drehzahl, 1 h Laufzeit und 20°C Raumtemperatur (nur bei Kühlzentrifuge)
- 2) Probenerwärmung bei maximaler Drehzahl und 1 h Laufzeit (nur bei Zentrifuge ohne Kühlung)
- 4) 5051 nicht mit Deckel 5053 verschließbar

- 1) Lowest possible temperature during maximum speed, 1 h running time and 20°C ambient temperature (only with cooling centrifuges)
- 2) Sample temp. rise during maximum speed and 1 h running time (only with centrifuges without cooling)
- 4) 5051 cannot be closed with lid 5053

1798	5051 + 5053						
Ausschwingrotor 4-fach / Swing out rotor 4-times  	 						
	5268	6306	6306				
	  						
		0509	---				
		 4)					
Kapazität / capacity	ml	4 - 7	15	12			
Maße / dimensions \varnothing x L	mm	16 x 75	17 x 120	17 x 100			
Anzahl p. Rotor / number p. rotor		48	28	28			
Drehzahl / speed	RPM	4000	4000	4000			
RZB / RCF		2808	2898	2898			
Radius / radius	mm	157	162	162			
 9 (97%)	sec	24					
 9	sec	≥ 17					
Temperatur / temperature	$^{\circ}\text{C}$ ¹⁾	- 8					
Probenerwärmung/Sample temp. rise	K ²⁾	11					

1798	5051 + 5280 5053								
Ausschwingrotor4-fach / Swing out rotor 4-times  	  								
	1662						1670		
	 2 x in 5280						 ¹²⁾ 2 x in 5280		
	1663	1664	1665	1666	1667	1668	1663	1664	
       									
Kapazität / capacity	ml	1	2	4	8	3 x 2	4 x 1	1	2
Maße / dimensions \varnothing / A	mm ²	6,2 / 30	8,7 / 60	12,4 / 120	17,5 / 240	8,7 / 60	6,2 / 30	6,2 / 30	8,7 x 60
Anzahl p. Rotor / number p. rotor		8	8	8	8	8	8	8	8
Filterkarten / filter cards		1675	1675	1675	1676	1677	1678	1692	1692
Drehzahl / speed	RPM	4000	4000	4000	4000	4000	4000	4000	4000
RZB / RCF		1735/2737	1735/2737	1735/2737	1735/2737	1735/2737	1735/2737	1735/2737	1735/2737
Radius / radius	mm	97 / 153	97 / 153	97 / 153	97 / 153	97 / 153	97 / 153	97 / 153	97 / 153
 9 (97%)	sec	24							
 9	sec	≥ 17							
Temperatur / temperature	$^{\circ}\text{C}$ ¹⁾	- 8							
Probenerwärmung/Sample temp. rise	K ²⁾	11							

1) Tiefste erreichbare Temperatur bei maximaler Drehzahl, 1 h Laufzeit und 20°C Raumtemperatur (nur bei Kühlzentrifuge)

2) Probenerwärmung bei maximaler Drehzahl und 1 h Laufzeit (nur bei Zentrifuge ohne Kühlung)

4) 5051 nicht mit Deckel 5053 verschließbar









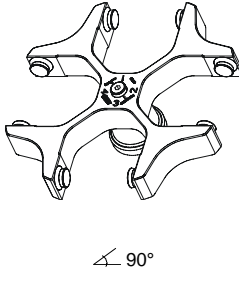
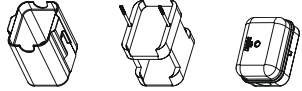
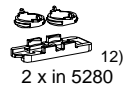

12) Objektträger nur belastbar bis RZB 1100

1) Lowest possible temperature during maximum speed, 1 h running time and 20°C ambient temperature (only with cooling centrifuges)

2) Sample temp. rise during maximum speed and 1 h running time (only with centrifuges without cooling)

4) 5051 cannot be closed with lid 5053

12) Object slide will not stand RCF values exceeding 1100

1798		5051 + 5280 5053							
Ausschwingrotor 4-fach / Swing out rotor 4-times  ↙ 90°									
		1670  12) 2 x in 5280				1470 			
		1665 	1666 	1667 	1668 	1471 	1475 		
		Kapazität / capacity ml	4	8	3 x 2	4 x 1	1 x 8	2 x 8	
Maße / dimensions Ø / A mm ²	12,4 x 120	17,5 x 240	8,7 / 60	6,2 / 30	17,5 / 240	17,5 / 240			
Anzahl p. Rotor / number p. rotor	8	8	8	8	8	8			
Filterkarten / filter cards	1692	1691	1694	1693	---	---			
Drehzahl / speed RPM	4000	4000	4000	4000	4000	4000			
RZB / RCF	1735/2737	1735/2737	1735/2737	1735/2737	1664/2665	1664/2665			
Radius / radius mm	97 / 153	97 / 153	97 / 153	97 / 153	93 / 149	93 / 149			
 9 (97%)			24						
 9			≥ 17						
Temperatur / temperature °C ¹⁾			- 8						
Probenerwärmung/Sample temp. rise K ²⁾			11						

1) Tiefste erreichbare Temperatur bei maximaler Drehzahl, 1 h Laufzeit und 20°C Raumtemperatur (nur bei Kühlzentrifuge)
 2) Probenerwärmung bei maximaler Drehzahl und 1 h Laufzeit (nur bei Zentrifuge ohne Kühlung)
 12) Objektträger nur belastbar bis RZB 1100

1) Lowest possible temperature during maximum speed, 1 h running time and 20°C ambient temperature (only with cooling centrifuges)
 2) Sample temp. rise during maximum speed and 1 h running time (only with centrifuges without cooling)
 12) Object slide will not stand RCF values exceeding 1100