



Sigma 3-18KS

from serial no. 146139



Refrigerated Centrifuge

Operating Manual

Please retain for later use!

In case of inquiries, please state the following numbers:

Order number:

Serial number:

© Copyright by
Sigma Laborzentrifugen GmbH
An der Unteren Söse 50
37520 Osterode am Harz
Germany

Tel.: +49 (0) 5522 / 5007-0
Fax: +49 (0) 5522 / 5007-12
Web: www.sigma-zentrifugen.de
E-mail: info@sigma-zentrifugen.de

Table of contents

1	General information	9
1.1	Importance of the operating manual.....	9
1.2	Intended use.....	9
1.3	Warranty and liability.....	9
1.4	Copyright.....	10
1.5	Standards and regulations.....	10
1.6	Scope of supply.....	10
2	Layout and mode of operation	11
2.1	Layout of the centrifuge.....	11
2.1.1	Functional and operating elements.....	11
2.1.2	Name plate.....	12
2.2	Mode of operation.....	13
2.2.1	Centrifugation principle.....	13
2.2.2	Area of application.....	13
2.2.2.1	Speed, radius, and relative centrifugal force.....	14
2.2.2.2	Density.....	14
3	Safety	15
3.1	Marking of the unit.....	15
3.2	Explanation of the symbols and notes.....	16
3.3	Responsibility of the operator.....	17
3.4	Operating personnel.....	17
3.5	Informal safety instructions.....	17
3.6	Safety instructions.....	18
3.6.1	Electrical safety.....	18
3.6.2	Mechanical safety.....	18
3.6.3	Fire prevention.....	19
3.6.4	Chemical and biological safety.....	19
3.6.5	Safety instructions for centrifugation.....	20
3.6.6	Resistance of plastics.....	20
3.6.7	Service life of rotors and accessories.....	21
3.7	Safety devices.....	22
3.7.1	Lid lock device.....	22
3.7.2	Standstill monitoring system.....	22
3.7.3	System check.....	22
3.7.4	Earth conductor check.....	22
3.7.5	Imbalance monitoring system.....	22
3.7.6	Temperature monitoring system.....	22
3.7.7	Rotor monitoring system.....	22
3.8	Measures in the event of hazards and accidents.....	23
3.9	Remaining hazards.....	23

Table of contents

4	Storage and transport	24
4.1	Dimensions and weight.....	24
4.2	Storage conditions	24
4.3	Notes on transport	24
4.4	Packaging.....	25
4.5	Transport safety device.....	25
5	Set-up and connection	26
5.1	Installation site	26
5.2	Power supply	26
5.2.1	Type of connection	26
5.2.2	Customer-provided fuses.....	26
6	Using the centrifuge	27
6.1	Initial start-up	27
6.2	Switching the centrifuge on	27
6.2.1	Opening and closing the lid.....	27
6.2.2	Installation of rotors and accessories.....	27
6.2.2.1	Installation of the rotor.....	27
6.2.2.2	Installation of angle rotors with a hermetically sealed lid	28
6.2.2.3	Installation of accessories	29
6.2.2.4	Adapters	30
6.2.2.5	Tubes.....	30
6.3	Control system "Spincontrol S"	31
6.3.1	User interface	31
6.3.2	Manual mode.....	32
6.3.2.1	Starting a centrifugation run	32
6.3.2.2	Interrupting a centrifugation run	32
6.3.2.3	Interrupting a deceleration process	32
6.3.2.4	Selection, display, and modification of data.....	32
6.3.2.5	Standard menu	33
6.3.2.6	Process library menu	39
6.3.2.7	Parameters menu	40
6.3.2.8	Setup menu	44
6.3.2.9	Curve menu	47
6.3.2.10	Help menu	48
6.3.2.11	Changing the contrast.....	49
6.3.3	Program mode.....	49
6.3.3.1	Saving a program.....	50
6.3.3.2	Loading a program.....	50
6.3.3.3	Executing a program.....	51
6.3.3.4	Deleting a program	51
6.3.3.5	Automatic program rotation.....	52
6.3.4	Options for data input and output.....	53
6.4	Switching the centrifuge off	53

Table of contents

7	Malfunctions and error correction	54
7.1	General malfunctions.....	54
7.1.1	Emergency lid release.....	55
7.2	Table of error codes.....	56
7.3	Service contact.....	57
8	Maintenance and service	58
8.1	Maintenance.....	58
8.1.1	Centrifuge.....	58
8.1.2	Condenser (only refrigerated centrifuges).....	59
8.1.3	Accessories.....	59
8.1.3.1	Plastic accessories.....	60
8.1.4	Rotors, buckets and carriers.....	60
8.1.5	Load bearing bolts.....	60
8.1.6	Glass breakage.....	61
8.2	Sterilisation and disinfection of the rotor chamber and accessories.....	61
8.2.1	Autoclaving.....	62
8.3	Service.....	63
8.4	Return of defective parts.....	64
9	Disposal	66
9.1	Disposal of the centrifuge.....	66
9.2	Disposal of the packaging.....	66
10	Technical data	67
10.1	Ambient conditions.....	67
10.2	Technical documentation.....	68
11	Appendix	69
11.1	Range of accessories.....	69
11.1.1	Maximum speed for tubes.....	72
11.1.2	Rotor radii.....	72
11.2	Speed-gravitational-field-diagram.....	73
11.3	Acceleration and deceleration curves.....	74
11.4	Table of the service life of rotors and accessories.....	76
11.5	Resistance data.....	77
11.6	EC declaration of conformity.....	81
12	Index	83

Table of contents

1 General information

1.1 Importance of the operating manual

A fundamental requirement for the safe and trouble-free operation of the centrifuge is to be familiar with the fundamental safety instructions and all possible hazards.

The operating manual includes important information concerning the safe operation of the centrifuge.

This operating manual and, in particular, the notes on safety and hazards must be observed by all persons operating the centrifuge.

In addition, the local rules and regulations for the prevention of accidents must be complied with.

1.2 Intended use

Centrifuges are power-driven machines that separate liquids from solid matter, liquid mixtures, or solid mixtures by centrifugal force. They are solely intended for this purpose. Any other use beyond this area of application is regarded as improper use. Sigma Laborzentrifugen GmbH cannot be held liable for any damage resulting from such improper use.

The intended use also includes

- observation of all the notes and instructions included in the operating manual and
- compliance with the care, cleaning, and maintenance instructions.

1.3 Warranty and liability

The warranty and liability are subject to our "General Conditions" that were distributed to the operator upon the conclusion of the contract.

Warranty and liability claims are excluded if they are due to:

- improper use.
- non-compliance with the safety instructions and hazard warnings in the operating manual.
- improper installation, start-up, operation, or maintenance of the centrifuge.

1 General information

1.4 Copyright

The copyright concerning the operating manual remains with Sigma Laborzentrifugen GmbH.

The operating manual is solely intended for the operator and their personnel. It includes instructions and information that must not be

- duplicated,
- distributed, or
- communicated in any other way.

Non-compliance may be prosecuted under criminal law.

1.5 Standards and regulations

EC declaration of conformity
(see chapter 11.6 - "EC declaration of conformity")

1.6 Scope of supply

The centrifuge comprises:

- | | |
|---|----------------------------------|
| • 1 rotor wrench, size 13 | Part no. 930 100 |
| • 1 tube of grease for load bearing bolts | Part no. 70 284 |
| • 1 connection cable | depending on the voltage variant |

Documentation

Operating manual incl. EC declaration of conformity
(see chapter 11.6 - "EC declaration of conformity")

Accessories

According to your order, our order confirmation, and your delivery note.

2 Layout and mode of operation

2.1 Layout of the centrifuge

2.1.1 Functional and operating elements

- 1 Lid
- 2 User interface
(see chapter 6.3.1 -
"User interface")
- 3 Mains switch



Fig. 1: Total view of the centrifuge

- 4 Name plate
(see chapter 2.1.2 -
"Name plate")
- 5 Mains power input
- 6 Equipotential
bonding screw



Fig. 2: Rear view of the centrifuge

2 Layout and mode of operation

2.1.2 Name plate

- 1 Manufacturer and registered office
- 2 Type
- 3 Serial number
- 4 Max. speed
- 5 Max. kinetic energy
- 6 Max. density
- 7 Nominal voltage
- 8 Input fuse
- 9 Symbol for special disposal (see chapter 9 - "Disposal")
- 10 CE mark in compliance with the directive 2006/42/EC
- 11 Part number
- 12 Year of manufacture
- 13 Power consumption



Fig. 3: Example of a name plate

2.2 Mode of operation

2.2.1 Centrifugation principle

Centrifugation is a process for the separation of heterogeneous mixtures of substances (suspensions, emulsions, or gas mixtures) into their components. The mixture of substances, which rotates on a circular path, is subject to centripetal acceleration that is several times greater than the gravitational acceleration.

Centrifuges use the mass inertia inside the rotor chamber for separating the substances. Due to their higher inertia, particles or media with a higher density travel outwards. In doing so, they displace the components with a lower density, which in turn travel towards the centre.

The centripetal acceleration of an object inside a centrifuge, as the effect of centripetal force, depends on the distance between the object and the axis of rotation as well as on the angular velocity. It increases linearly as a function of the distance with regard to the axis of rotation and quadratically as a function of the angular velocity. The bigger the radius in the rotor chamber is and the higher the speed is, the higher the centripetal acceleration is. However, the forces acting on the rotor also increase.

2.2.2 Area of application

Depending on the area of application of the centrifuge and also on the particle size, solids content, and volume throughput of the mixture of substances that is to be centrifuged, there are different types of centrifuges. The areas of application go from household use as a salad spinner or honey separator up to specialised technical applications in the clinical, biological, or biochemical context:

- For numerous clinical examinations, cellular material must be separated from the liquid to be analysed. The normal separation process can be sped up considerably by using laboratory centrifuges.
- In the metal-working industry, centrifuges are used for separating oil from metal cuttings. Dairies use centrifuges in order to separate cow's milk into cream and low-fat milk.
- Particularly big centrifuges are used in the sugar industry for separating the syrup from the crystalline sugar.
- Ultracentrifuges are predominantly used in biology and biochemistry in order to isolate particles, e.g. viruses. They are specifically designed for high speeds up to 500,000 rpm. The rotor moves in a vacuum in order to avoid air friction.

2 Layout and mode of operation

2.2.2.1 Speed, radius, and relative centrifugal force

The acceleration g , which the samples are subject to, can be increased by increasing the radius in the rotor chamber and by increasing the speed. These three parameters are interdependent and linked with each other via the following formula:

$$\text{Relative centrifugal force RCF} = 11.18 \times 10^{-6} \times r \times n^2$$

r = radius in cm

n = speed in rpm

RCF without any dimension

If two values are entered, the third value is determined by way of the stated formula. If, afterwards, the speed or the radius is changed, the resulting relative centrifugal force will be recalculated automatically by the control unit. If the RCF is changed, the speed will be adapted while the specified radius is maintained.

The speed-gravitational-field-diagram provides an overview of the relationship between speed, radius, and RCF (see chapter 11.2 - "Speed-gravitational-field-diagram").

2.2.2.2 Density

The laboratory centrifuge is suitable for the separation of constituents of different densities in mixtures with a maximum density of 1.2 g/cm^3 . All information concerning the speed of rotors and accessories refers to liquids with a density corresponding to this specification. If the density is above this value, the maximum permissible speed of the centrifuge must be reduced based on the following formula:















$$n = n_{\max} \times \sqrt{(1.2 / \text{Rho})}$$

Rho = density in g/cm^3

3 Safety

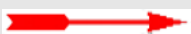
3.1 Marking of the unit

The following symbols are used for all types of centrifuges manufactured by Sigma:

	Dangerous voltage		On (Power)
	Hot surface		Off (Power)
	Caution! Risk of bruising		Name plate (see chapter 2.1.2 - "Name plate")
	Protective earth (ground)		CE mark in compliance with the directive 2006/42/EC
	Earth (ground)		Do not dispose as part of domestic waste
	Unplug the mains plug		GS mark (tested safety; only for Germany)
	Arrow indicating the direction of rotation		NRTL mark (only for the USA and Canada)
	4°C Guarantee		RCM mark (only for Australia)
	Centrifuge with heating system		

i
NOTE

Safety indications on the centrifuge must be kept readable at all times. If necessary, they must be replaced.

i
NOTE

Not all of the symbols/labels are used for this centrifuge type.

3 Safety

3.2 Explanation of the symbols and notes

In this operating manual, the following names and symbols to indicate hazards are used:



This symbol stands for a **direct** hazard to the life and health of persons.

Non-observance of these symbols **causes** serious health problems up to life-endangering injuries.



This symbol stands for a **direct** hazard to the life and health of persons due to electrical voltage.

Non-observance of these symbols **causes** serious health problems up to life-endangering injuries.



This symbol stands for a **potential** hazard to the life and health of persons.

Non-observance of these symbols **can** cause serious health problems up to life-endangering injuries.



CAUTION

This symbol indicates a potentially hazardous situation

Non-observance of these notes can cause minor injuries or damage to property.



NOTE

This symbol indicates important information.

3.3 Responsibility of the operator

The operator is responsible for authorising only qualified personnel to work on the centrifuge (see chapter 3.4 - "Operating personnel").

The areas of responsibility of the personnel concerning the operation, maintenance, and care of the unit must be clearly defined.

The safety-conscious work of the personnel in compliance with the operating manual and the relevant EC and national health and safety regulations as well as with the accident prevention regulations must be checked at regular intervals (e.g. every month).

Under the international rules for health and safety at work, the operator is obliged to:

- take measures in order to prevent all danger to life or health during work.
- ensure that centrifuges are operated properly and entirely as intended (see chapter 1.2 - "Intended use").
- take protective measures against fire and explosion when working with hazardous substances.
- take measures for the safe opening of centrifuges.

3.4 Operating personnel

Persons operating the unit must

- be familiar with the fundamental regulations concerning workplace safety and accident prevention
- have read and understood this operating manual (and in particular the safety sections and warning notes) and confirmed this with their signature.

3.5 Informal safety instructions

- This operating manual is a part of the product.
- The operating manual must be kept at the location of use of the centrifuge. Ensure that it is accessible at all times.
- The operating manual must be handed over to any subsequent owner or operator of the centrifuge.
- Any changes made must be added to the operating manual.
- In addition to the operating manual, the general and local rules and regulations concerning the prevention of accidents and the protection of the environment must also be supplied.
- Safety and danger indications on the centrifuge must be kept readable at all times. If necessary, they must be replaced.

3 Safety

3.6 Safety instructions

3.6.1 Electrical safety

To reduce the risk of electrical shock, the centrifuge uses a three-wire electrical cord and plug to connect the equipment to earth-ground. To preserve this safety feature:



DANGER

- Ensure that the wall socket is properly wired and grounded.
- Check that the mains voltage agrees with the nominal voltage listed on the name plate.
- Do not place vessels containing liquid on the centrifuge lid or within the safety distance of 30 cm around the centrifuge. Spilled liquids may get into the centrifuge and damage electrical or mechanical components.
- Work on the power supply system must only be performed by certified electricians.
- Inspect the electrical equipment of the unit regularly. Defects such as loose or burnt cables must be eliminated immediately.

3.6.2 Mechanical safety

In order to ensure the safe operation of the centrifuge, observe the following:



WARNING

- Do not open the lid when the rotor is in motion!
- Do not reach into the rotor chamber when the rotor is in motion!
- Do not use the centrifuge if it was installed incorrectly.
- Do not use the centrifuge without panels.
- Do not use the centrifuge if the rotors and inserts show signs of corrosion or other defects.
- Only use the centrifuge with rotors and accessories that have been approved by the manufacturer. In case of doubt, contact the manufacturer (see chapter 7.3 - "Service contact").
- Do not hold your fingers between the lid and the housing when closing the lid. Risk of crushing!
- Defective lid relieving devices could cause the centrifuge lid to fall (contact the service department, if necessary). Risk of crushing!
- Do not hit or move the centrifuge during its operation.
- Do not lean against or rest on the centrifuge during its operation.
- Do not spin any substances that could damage the material of the rotors and buckets of the centrifuge in any way. Highly corrosive substances, for example, damage the material and affect the mechanical strength of the rotors and buckets.
- Stop the centrifuge immediately in the event of a malfunction. Eliminate the malfunction (see chapter 7 - "Malfunctions and error correction") or inform the service department of the manufacturer (see chapter 7.3 - "Service contact").
- Ensure that all repairs are performed only by authorised and specialised personnel.

WARNING

- Prior to any start-up, check the centrifuge, rotor, and accessories for signs of damage that can be discerned from the outside. Special attention must be paid to all of the rubber parts (e.g. motor cover, lid seal, and adapters) in terms of visible structural changes. Defective parts must be replaced immediately.
- Open the centrifuge when it is not in use so that moisture can evaporate.

3.6.3 Fire prevention

DANGER

- Do not spin explosive or inflammable substances.
- Do not use the centrifuge within hazardous locations.

3.6.4 Chemical and biological safety

If pathogenic, toxic, or radioactive samples are intended to be used in the centrifuge, it is in the responsibility of the user to ensure that all necessary safety regulations, guidelines, precautions, and practices are adhered to accordingly.

DANGER

- Infectious, toxic, pathogenic, and radioactive substances may only be used in special, certified containment systems with a bio-seal in order to prevent the material from being released.
- Take suitable precautions for your own safety if there is a risk of toxic, radioactive, or pathogenic contamination
- Materials that chemically react with each other with a high level of energy are prohibited.

WARNING

- Keep informed about local measures to avoid harmful emissions (depending on the substances to be centrifuged).
- Protective clothing is not required for the operation of the centrifuge. The materials to be centrifuged may, however, require special safety measures (e.g. centrifugation of infectious, toxic, radioactive, or pathogenic substances).

3 Safety

3.6.5 Safety instructions for centrifugation

For safe operation, observe the following before starting the centrifuge:



WARNING

- Ensure that the centrifuge was set up properly (see chapter 5 - "Set-up and connection").
- Maintain a safety distance of at least 30 cm (12 inches) around the centrifuge.
- Do not store any dangerous goods in the centrifuge area.
- Do not stay in the safety area longer than what is absolutely necessary for the operation of the centrifuge.
- Only use the centrifuge with rotors and accessories that have been approved by the manufacturer. We explicitly warn against the use of equipment of poor quality. Breaking glass or bursting vessels can cause dangerous imbalances at high speeds
- Ensure that rotor and buckets are correctly fitted (see chapter 6.2.2.1 - "Installation of the rotor").
- Observe the instructions on the installation of accessories (see chapter 6.2.2.3 - "Installation of accessories").
- The rotor must be loaded axial symmetrically at equal weights.
- If liquids with a density $> 1.2 \text{ g/cm}^3$ are used, reduce the speed (see chapter 2.2.2.2 - "Density").
- Do not use the centrifuge if the rotor is loaded asymmetrically.
- Do not use the centrifuge with tubes that are excessively long.



WARNING

3.6.6 Resistance of plastics

Chemical influences have a strong effect on the polymeric chains of plastics, and, therefore, on their physical properties. Plastic parts can be damaged if solvents, acids, or alkaline solutions are used.



NOTE

- Refer to the resistance data (see chapter 11.5 - "Resistance data")!

3.6.7 Service life of rotors and accessories

The rotors and accessories have a limited service life.



WARNING

- Perform regular checks (at least once per month) for safety reasons!
- Pay special attention to changes, such as corrosion, cracks, material abrasion, etc.
- After 10 years, they must be inspected by the manufacturer.
- After 50,000 cycles, the rotor must be scrapped for reasons of safety.
- If other data concerning the service life are engraved on the rotor or bucket, these data shall apply accordingly. For example, a bucket with the engraving "max. cycles = 10,000" has a service life of 10,000 cycles, and a rotor with the engraving "Exp. date 02/20" must be scrapped in February 2020 at the latest (see figure).



Fig. 4: Different service life – engraving on the bucket/rotor



NOTE

- Refer to the table of rotors and accessories with a different service life (see chapter 11.4 - "Table of the service life of rotors and accessories")!

3 Safety

3.7 Safety devices

3.7.1 Lid lock device

The centrifuge can only be started when the lid is properly closed. The electrical lock must be locked. The lid can only be opened when the rotor has stopped. If the lid is opened by way of the emergency release system during operation, the centrifuge will immediately switch off and decelerate brakeless. If the lid is open, the drive is completely separated from the mains power supply, i.e. the centrifuge cannot be started (see chapter 7.1.1 - "Emergency lid release").

3.7.2 Standstill monitoring system

Opening of the centrifuge lid is only possible if the rotor is at a standstill. This standstill is checked by the microprocessor.

3.7.3 System check

An internal system check monitors the data transfer and sensor signals with regard to plausibility. Errors are detected with extreme sensitivity and displayed as error messages in a dialog box (see chapter 7.2 - "Table of error codes").

3.7.4 Earth conductor check

For the earth conductor check, there is an equipotential bonding screw on the rear panel of the centrifuge (see chapter 2.1.1 - "Functional and operating elements"). An earth conductor check can be carried out by authorized and specialized personnel using a suitable measuring instrument. Please contact the service department (see chapter 7.3 - "Service contact").

3.7.5 Imbalance monitoring system

A dialog box may pop up or emit a sound signal in order to indicate that the centrifuge is in the inadmissible imbalance range. If the rotor is loaded unevenly, the drive will be switched off in the acceleration phase or during the run.

3.7.6 Temperature monitoring system

If the temperature inside the rotor chamber rises above 50°C, the drive system will be switched off automatically. The centrifuge cannot be restarted until it has cooled.

3.7.7 Rotor monitoring system

When a rotor number and, if applicable, a bucket number are selected, the computer will automatically check whether the entered speed or the entered gravitational field are permissible for the selected rotor.

3.8 Measures in the event of hazards and accidents



DANGER

- If an emergency arises, switch off the centrifuge immediately!
- If in doubt, call the emergency doctor!

3.9 Remaining hazards

The unit was built state- of- the- art and according to the accepted safety rules. However, danger to life and limb of the operator, or of third parties, or impairments of the unit or other material assets cannot be completely excluded when the unit is being used.

- Use the unit only for the purpose that it was originally intended for (see chapter 1.2 - "Intended use").
- Use the unit only if it is in a perfect running state.
- Immediately eliminate any problems that can affect safety.

4 Storage and transport

4 Storage and transport

4.1 Dimensions and weight

	Sigma 3-18KS
Height:	355 mm
Height with open lid:	795 mm
Width:	630 mm
Depth:	600 mm
Weight:	78 kg

4.2 Storage conditions

The centrifuge can be stored in its original packaging for up to a year.

- Store the centrifuge only in dry rooms.
- The permissible storage temperature is between -20°C and +60°C.
- If you would like to store it for more than one year, or if you intend to ship it overseas, please contact the manufacturer.

4.3 Notes on transport

- Install the transport safety device (see chapter 4.5 - "Transport safety device").
- Always lift the centrifuge with a lifting device.
- When lifting the centrifuge, always reach under the centrifuge from the side.



CAUTION

The centrifuge weighs approx. 78 kg!

- For transport, use suitable packaging and, if at all possible, the original packaging (see chapter 4.4 - "Packaging").

4.4 Packaging

The centrifuge is packaged in a wooden crate.

- After taking off the lid, remove the side panels.
- Remove the packaging material.
- Lift the centrifuge upwards with a lifting device to lift it safely. When lifting the centrifuge, always reach under the centrifuge from the side.



CAUTION

The centrifuge weighs approx. 78 kg!

- Retain the packaging for any possible future transport of the centrifuge.

4.5 Transport safety device

The transport safety device consists of a foamed plastic piece in the rotor chamber.



CAUTION

The transport safety device must be removed prior to start-up because the screws lock the motor bearings!

Removal

- Open the lid by pressing the lid key. If the centrifuge is not connected to the power supply, use the emergency release of the lid (see chapter 7.1.1 - "Emergency lid release").
- Remove the foamed plastic piece (see figure, item 1) from the rotor chamber, by lifting it carefully on one side.
- Retain the transport safety device for the possibility of the return of the centrifuge.

5 Set-up and connection

5 Set-up and connection

5.1 Installation site

Operate the centrifuge only in closed and dry rooms.

All the energy supplied to the centrifuge is converted into heat and emitted to the ambient air.

- Ensure sufficient ventilation.
- Keep a safety distance of at least 30 cm around the centrifuge so that the vents in the centrifuge remain fully effective.
- Do not subject the centrifuge to thermal stress, e.g. by positioning it near heat generators.
- Avoid direct sunlight (UV radiation).
- The table must be stable and have a solid, even surface.
- Attention: During transport from cold to warmer places, condensational water will collect inside the centrifuge. It is important to allow sufficient time for drying (min. 24 h) before the centrifuge can be used again.

5.2 Power supply

5.2.1 Type of connection



DANGER

The operating voltage on the name plate must correspond to the local supply voltage!

Sigma centrifuges are units of protection class I. The centrifuges of this model series have a three-wire power cord with an IEC C13 connector. They are equipped with a mains power switch with an integrated thermal circuit breaker.

- Switch the unit off by actuating the mains power switch.
- If it has tripped, let the circuit breaker cool for approximately 2 minutes.
- Switch the unit on.

The centrifuge is now ready for operation.

5.2.2 Customer-provided fuses

Typically, the centrifuge must be protected with 16 Amp L or B fuses that are to be provided by the customer.

6 Using the centrifuge

6.1 Initial start-up



DANGER

- Before the initial start-up, please ensure that your centrifuge is properly set up and installed (see chapter 5 - "Set-up and connection").

6.2 Switching the centrifuge on

- Press the mains power switch.

The display then illuminates. The centrifuge is ready for operation.

6.2.1 Opening and closing the lid

The lid can be opened if the centrifuge is at a standstill and if the lid key is illuminated.

- Press the lid key in order to open the lid.

The centrifuge cannot be started if the lid is opened.

- To close, press with both hands slightly on the lid until the electrical lock is locked.



WARNING

Do not place your fingers between the lid and the housing when closing the lid. Risk of crushing!

6.2.2 Installation of rotors and accessories

6.2.2.1 Installation of the rotor

- Open the centrifuge lid by pressing the lid key.
- Unscrew the rotor tie-down screw from the motor shaft (counter-clockwise).
- Lower the rotor with its central bore straight down onto the motor shaft.
- Tighten the rotor tie-down screw clockwise with the supplied rotor wrench with 7.5 Nm. In doing so, hold the rotor at its outer rim.



WARNING

Once a day or after 20 cycles, the rotor tie-down screw must be loosened by some turns, and the rotor must be lifted and fastened again. This ensures a proper connection between the rotor and the motor shaft.

6 Using the centrifuge



CAUTION

When using rotors for microtiter plate formats:
Ensure that the plate holders are inserted together with the plates into the buckets.



NOTE

The lid screw serves for the fastening of the lid onto the rotor only, not for the fastening of the rotor onto the motor shaft.

- Follow the safety instructions and hazard warnings (see chapter 3 - "Safety")!

6.2.2.2 Installation of angle rotors with a hermetically sealed lid

- Screw the rotor cover onto the rotor and tighten it.
- Lower the rotor with the cover onto the motor shaft .
- Insert the rotor tie-down screw into the motor shaft. Tighten the rotor tie-down screw with 7.5 Nm using the supplied rotor wrench so that the spring washer assembly is compressed tightly.
- The rotor can also be used without a cover.
- The rotors can be installed or removed with a closed lid after loosening the rotor tie-down screw.
- Follow the safety instructions and hazard warnings (see chapter 3 - "Safety")!

- 1 Rotor tie-down screw
- 2 Lid
- 3 Rotor

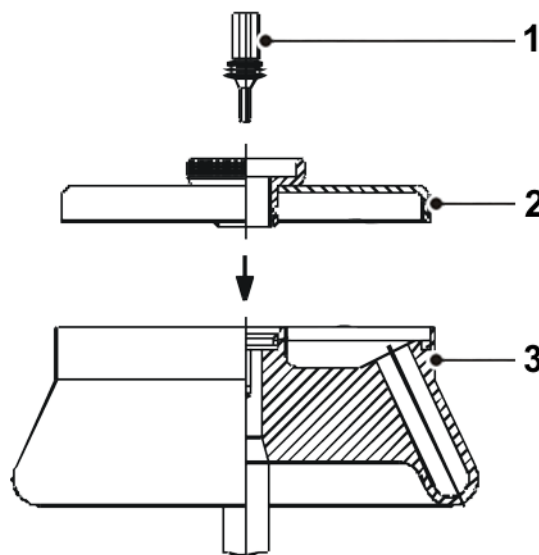

Fig. 5: Angle rotor with a hermetically sealed lid

6.2.2.3 Installation of accessories

- Only use inserts that are suitable for the rotor (see chapter 11.1 - "Range of accessories").
- All buckets of the swing-out rotor need to be installed when spinning.
- Always load the axial symmetrical inserts/buckets of the rotors with the same accessories and fill to avoid imbalance.

Centrifugation with different tube sizes

Working with different tube sizes is possible. In this case, however, it is very important that axial symmetrical inserts are identical.

correct

incorrect

Fig. 6: Permissible and impermissible loading of a swing-out rotor with different tube sizes (example illustrations)

Centrifugation with low capacity

- Install the tubes axial symmetrically so that the buckets and their inserts are loaded evenly.
- It is not permissible to load angle rotors on only one axis.

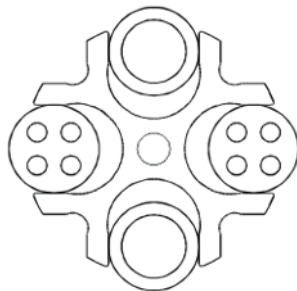
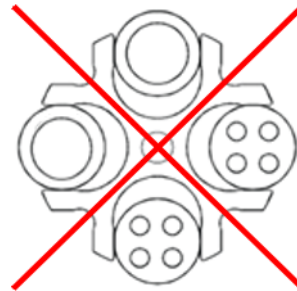
correct

incorrect

Fig. 7: Permissible and impermissible loading of an angle rotor and a swing-out rotor (example illustrations)

6 Using the centrifuge

6.2.2.4 Adapters

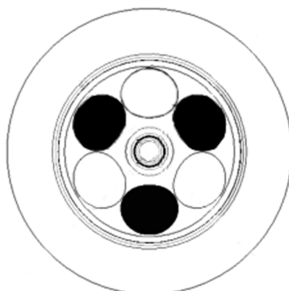
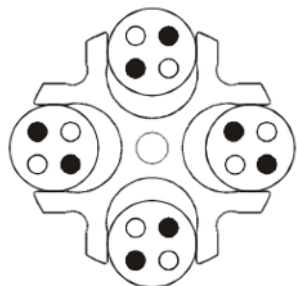
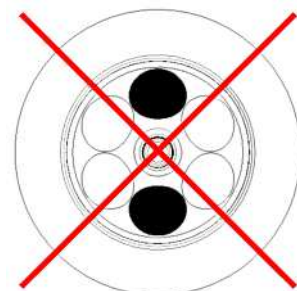
In order to ensure easy handling, even if vessels of various sizes are used, carrier systems were developed.

- Load the opposite adapters with the same number of vessels and with the same weights in order to avoid imbalance.
- If all of the compartments of a carrier are not used, the buckets must be loaded evenly. Loading the edges of a bucket only is not permissible.

6.2.2.5 Tubes

- Load the tubes outside of the centrifuge. Liquids in the buckets or multiple carriers cause corrosion .
- Fill the tubes carefully and arrange them according to their weight. Imbalances result in the excessive wear of the bearings.
- In high-speed angle rotors, the vessels must be filled up to their useful volume (= the volume stated for the vessel). If the vessels are only partially filled, they will deform. This may result in leaks at the seals that may become loose.
- When using glass tubes, the maximum value of 4,000 x g must not be exceeded (except special high-strength glass tubes; please refer to the information provided by the manufacturer).
- Follow the safety instructions and hazard warnings (see chapter 3 - "Safety")!

6.3 Control system "Spincontrol S"

6.3.1 User interface

The centrifuge is operated via three buttons with integrated light-emitting diodes and one function knob. The display is divided into several different fields. The various functions of the system can be called up by pressing and turning the function knob.

- 1 Start button
- 2 Display
- 3 Function knob
- 4 Stop button
- 5 Lid button

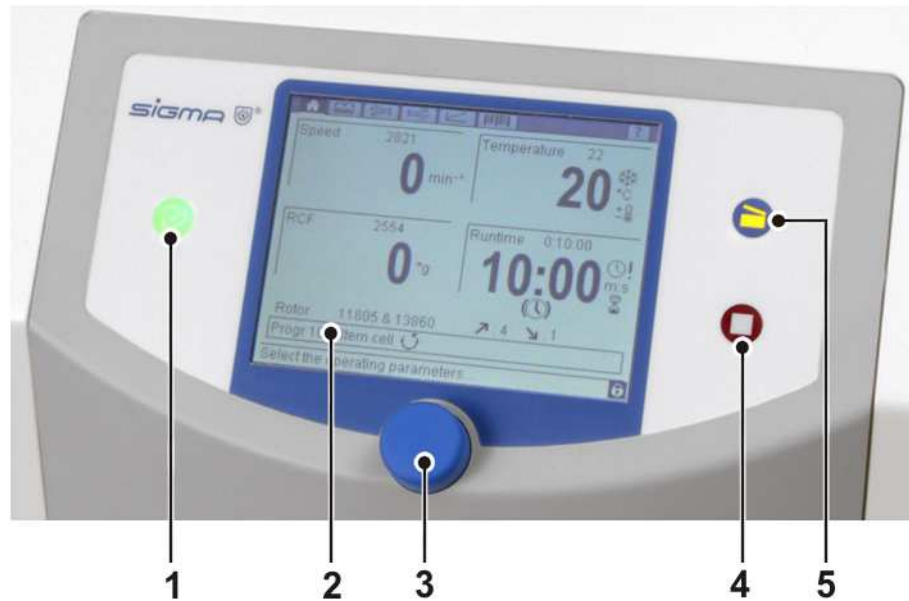

Fig. 8: User interface of the Spincontrol S control system

Display

The centrifuge display has the following fields:

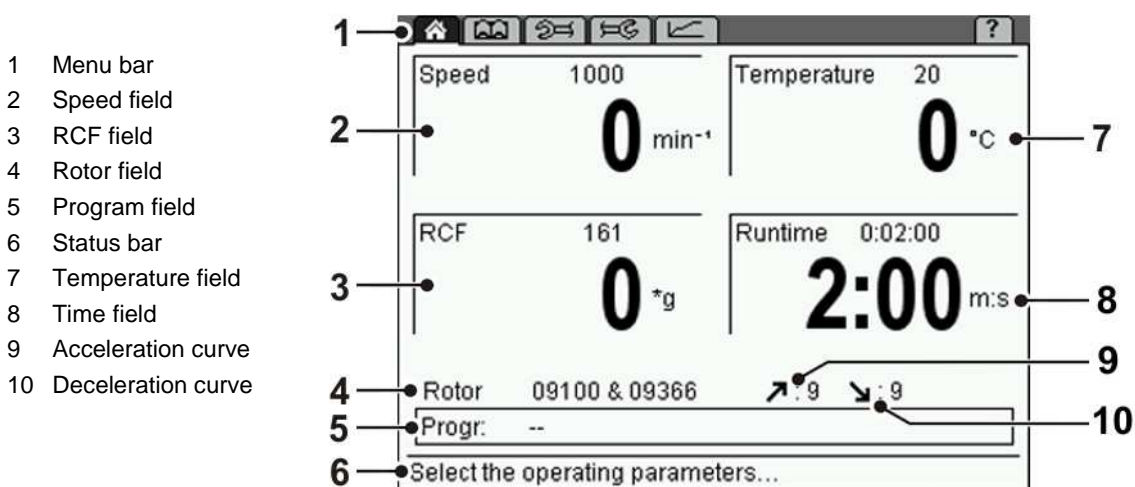

Fig. 9: Display of the Spincontrol S control system

6 Using the centrifuge

6.3.2 Manual mode

6.3.2.1 Starting a centrifugation run

The centrifuge is ready for operation when the start key is illuminated.

- Press the start key in order to start a centrifugation run.

6.3.2.2 Interrupting a centrifugation run

- Press the stop key in order to interrupt a centrifugation run. The centrifugation run will be terminated prematurely.

Quick stop

- Press the stop key for more than three seconds.

The centrifuge decelerates with the maximum deceleration curve.

After a quick stop, the centrifuge lid must be opened before a new centrifugation run can be started.

A quick stop can also be triggered during a normal deceleration, e.g. in order to speed up the deceleration.

When a quick stop is triggered, "Quick stop" will be displayed in the speed field.



NOTE

A quick stop can be performed even if the centrifuge is blocked against unauthorised use.

6.3.2.3 Interrupting a deceleration process

- Press the start key during a deceleration process in order to interrupt it and to restart the centrifuge.

6.3.2.4 Selection, display, and modification of data

The "Standard" menu is displayed.

- Turn the function knob in order to select a field. The selected field is inverted.
- Press the function knob. The display starts to flash and the modification mode is active.
- Turn the function knob in order to modify the set value of the selected field.
- Press the function knob again to confirm the entry and to quit the modification mode.

6.3.2.5 Standard menu

The "Standard" menu is symbolised by the icon "⚙️" on the menu bar and it is displayed a few seconds after the centrifuge has been switched on. In this menu, the parameters of a centrifugation run can be displayed and modified.

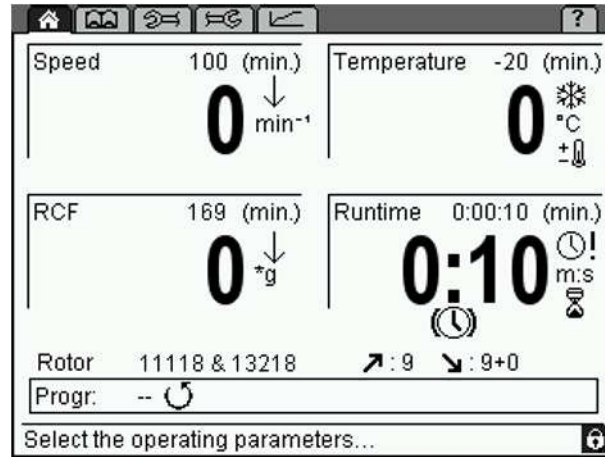

Fig. 10: Standard menu; here shown with all of the possible symbols

Speed

In the upper section of the field, the set speed of the centrifuge is displayed. The actual speed is displayed below this value. The values are stated in revolutions per minute ($\text{min}^{-1} = \text{rpm}$) and depend on the RCF values (see chapter 2.2.2.1 - "Speed, radius, and relative centrifugal force"). The maximum speed values depend on the rotor that is used.

Relative centrifugal force (RCF)

The relative centrifugal force is the acceleration that the sample is subjected to during the centrifugation run. The set value of this parameter is displayed in the upper section of this field, with the actual value shown below. The values are stated in g (gravitational acceleration) and they depend on the speed values (see chapter 2.2.2.1 - "Speed, radius, and relative centrifugal force"). The maximum RCF values depend on the rotor that is used.

Temperature

The set temperature is displayed in the upper section of the field, with the current rotor chamber temperature shown below. Temperatures between -20 °C and $+40\text{ °C}$ can be preselected.



NOTE

The centrifuge is not equipped with an active heater. As a result, temperatures above room temperature depend on the air friction of the running motor.

6 Using the centrifuge

Runtime

The set runtime is displayed in the upper section of this field, with the remaining runtime shown below. The runtime is defined as the period from the start of the centrifuge to the beginning of the deceleration phase. The maximum value is 99 h 59 min 59 sec.

In the "Setup" menu , it can be specified that the runtime is not to be started until the set speed is reached (see chapter 6.3.2.8 - "Setup menu"). In this case, the symbol "!" appears in the runtime field.

Continuous run

During the continuous run, the runtime of the centrifuge is unlimited and must be stopped manually. The centrifuge accelerates during the continuous run until the set speed is reached.

- Select the field "Runtime" and confirm the selection. The display flashes when it is activated.
- Turn the function knob from the time 0:00:10 anti-clockwise or from the time 99:59:59 clockwise. "Infinite" will be displayed. After the start of the centrifuge, the elapsed time will be displayed.
- Deactivate the continuous run by pressing the stop button or by entering a specific runtime.

Short run

A short run can be started if no run is active.

- Keep the start button pressed during the short run.

During the short run, the centrifuge accelerates with acceleration curve 9 (maximum acceleration) until the maximum speed of the rotor is reached. The runtime is counted and in the speed field the message "Short run" flashes.

When the start button is released, the centrifuge decelerates with the maximum deceleration curve to a standstill.



NOTE

The parameters speed, RCF, temperature, and runtime can be changed during the centrifugation.



NOTE

If the centrifuge is locked with level 02 or higher, it is not possible to start a short run.

Rotor: rotor selection list

This field shows the rotor that is currently being used.

- Select the field "Rotor" and confirm the selection. A list with all of the possible rotors without buckets is displayed.
- Select the desired rotor.
 - If an angle rotor is selected, additional information concerning this rotor will be displayed.
 - In the case of swing-out rotors, a list with all of the possible rotor/bucket combinations will be displayed. Select an item from the list so that the additional information concerning the combination will be displayed.
- Press the function knob in order to accept the data.

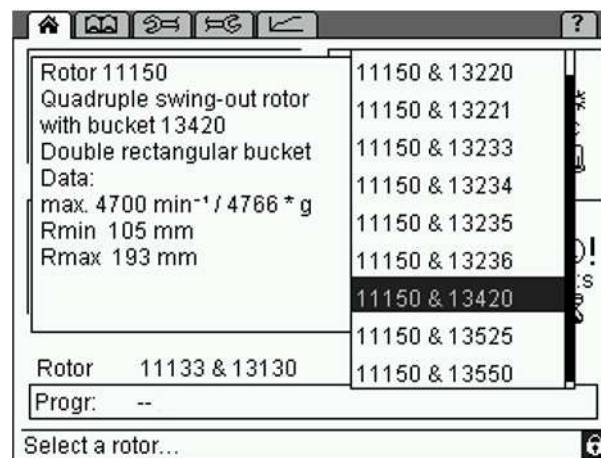

Fig. 11: Rotor selection list, here with potential rotor-bucket combinations and additional information

Automatic rotor identification

The centrifuge automatically identifies the rotor that is currently being used.

- If the system identifies a different rotor than the one that is set and if there are no different buckets for this rotor, the rotor input will be adapted automatically. The system will not display a message.
- If the system identifies a different rotor than the one that is set, and if there are different rotor/bucket combinations for this rotor, the system will automatically identify the correct rotor and select the rotor/bucket combination with the lowest speed. The system will display a corresponding message so that the combination can be adapted manually.
- If the system cannot identify the rotor, a message will be displayed. The rotor cannot be used in the centrifuge.

This prevents the maximum permissible speed from being exceeded.

6 Using the centrifuge

Acceleration ↗

This function is used to select an acceleration curve. One can select a linear rise (curves 0-9) or a quadratic rise (curves 10-19). The acceleration curves 20-29 can be programmed as desired (see chapter 11.3 - "Acceleration and deceleration curves").

Deceleration (brake) ↘

This function is used to select a curve that decelerates the centrifuge to a standstill. Deceleration curves are inverted images of the acceleration curves and are labelled with identical numbers. Deceleration curve no. 0 represents a brakeless deceleration.

Progr.: program list

This field in the "Standard" menu shows the program that is currently loaded. When the field is selected, the program list is displayed (for information on how to work with the programs, please see chapter 6.3.3 - "Program mode").

The program "RAPID_TEMP" (see below) cannot be deleted.

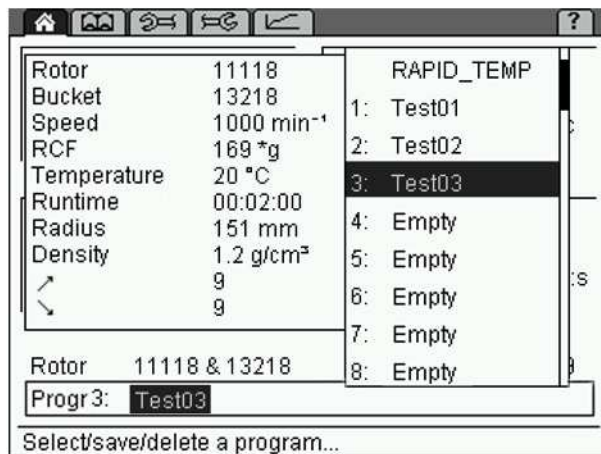



Fig. 12: Program list

Program "RAPID_TEMP"

Precooling or preheating at a standstill may distort the measurement results and cause the increased wear of the mechanical components. This is why the centrifuge has a special program that precools or preheats the rotor chamber rapidly to a preset value under defined conditions.

- Select the option "Progr" in the "Standard" menu  and confirm the selection. The program list will be displayed.
- Select the program "RAPID_TEMP" on the program list and confirm the selection. The display shows $\frac{1}{3}$ of the maximum rotor speed and the corresponding RCF value. The deceleration (brake) and acceleration curves correspond to curve 9 and the runtime field indicates "infinite" (continuous run).

6 Using the centrifuge

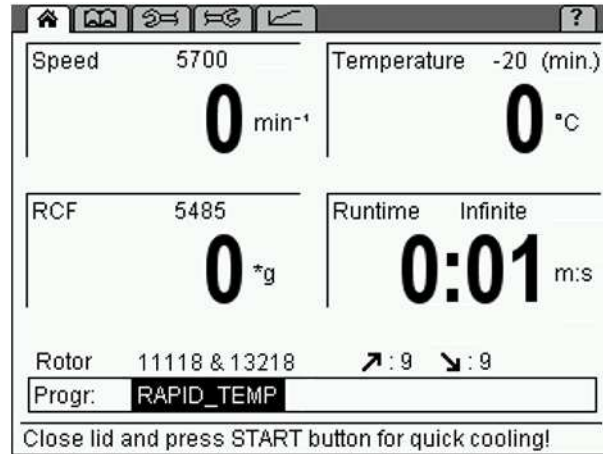

Fig. 13: Program "RAPID_TEMP"

i NOTE

The program will only be loaded if the actual temperature is above the set temperature.

- Press the start button in order to start the rapid cooling run.
- During the rapid cooling run, the set temperature can be modified within the range below the actual temperature.

The current status of the program will be displayed on the status bar.

The "RAPID_TEMP" program will be stopped under the following conditions:

- The set value is reached. In this case, the "RAPID_TEMP" program stops with a sound signal and the standstill cooling system will be activated.
- The stop button is pressed. The "RAPID_TEMP" program will be stopped prematurely. No message will be issued when the set temperature is reached.
- A parameter is changed (except for the temperature) or another input is made. In this case, the "RAPID_TEMP" program will be aborted. No message will be issued when the set temperature is reached.

After the stop, the previous program will be reloaded or the changed parameters will be adopted as the new settings.

i NOTE

The automatic lid opening function is suppressed after a rapid cooling run in order to prevent the system from reheating.

i NOTE

The delta T temperature monitoring system (see chapter 6.3.2.7 - "Parameters menu", Process) remains inactive as long as the "RAPID_TEMP" program is active.

6 Using the centrifuge



If the "RAPID_TEMP" program is used, the temperature of the unloaded aluminium bucket will be displayed. If samples, which have not been precooled, are placed into the buckets, the displayed temperature will deviate from the actual sample temperature.

Progress indicator

The progress indicator provides a quick overview of the remaining runtime of the running centrifugation run. For this purpose, a green progress bar and percentage value are displayed in the program field.

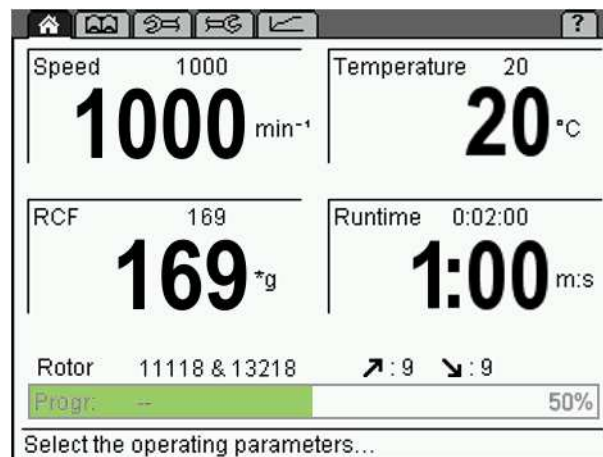

Fig. 14: Progress indicator during a centrifugation run

After the completion of the centrifugation run, the progress indicator remains at 100% until

- the lid is opened,
- a parameter is changed,
- a program is loaded, saved, or deleted, or
- a new centrifugation run is started.

6.3.2.6 Process library menu

The process library can be opened via the "📖" symbol on the menu bar. It provides the user with an overview of all of the stored programs as processes.

The processes are listed with their name, RCF, runtime, and temperature (exception: the "RAPID_TEMP" program will not be listed).

The order of the processes corresponds to their storage locations on the program list. Empty storage locations will not be displayed. If more than 11 programs have been stored, the user can scroll through the list.

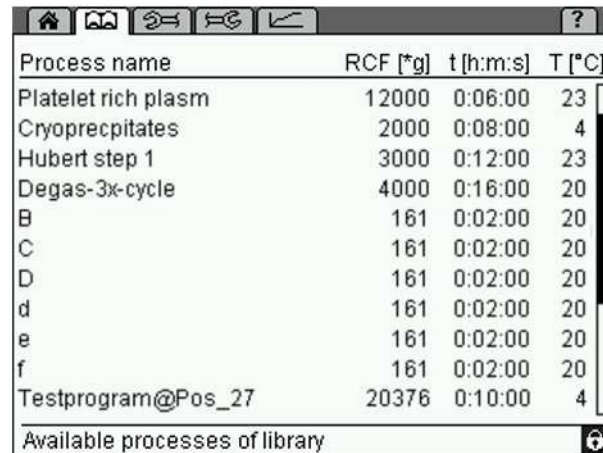

Process name	RCF [*g]	t [h:m:s]	T [°C]
Platelet rich plasm	12000	0:06:00	23
Cryoprecipitates	2000	0:08:00	4
Hubert step 1	3000	0:12:00	23
Degas-3x-cycle	4000	0:16:00	20
B	161	0:02:00	20
C	161	0:02:00	20
D	161	0:02:00	20
d	161	0:02:00	20
e	161	0:02:00	20
f	161	0:02:00	20
Testprogram@Pos_27	20376	0:10:00	4

Available processes of library

Fig. 15: Process library menu

Loading a process

- In the process library, select the desired process by turning the function knob. Press the function knob in order to confirm the selection.

The process will be loaded and the "Standard" menu 🏠 will be displayed.

Starting a process

- In the process library, select the desired process by turning the function knob. Then, press the start button.

The process will be loaded and started. The "Standard" menu 🏠 will be displayed.

6 Using the centrifuge

6.3.2.7 Parameters menu

The "Parameters" menu is symbolised by the "⚙️" symbol on the menu bar. It is used to specify various conditions for the centrifugation. These conditions are used to monitor the process and to control access to the centrifuge.

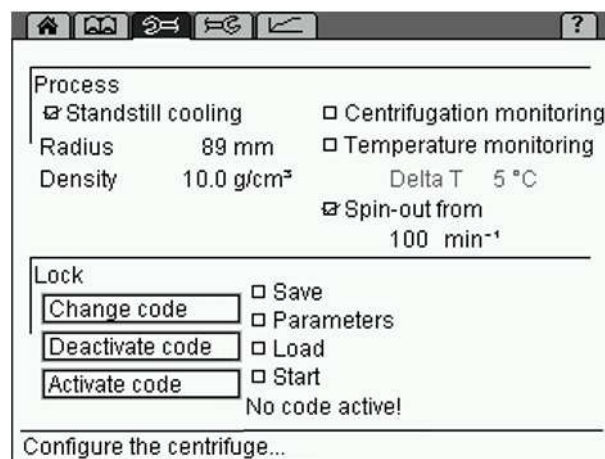

Fig. 16: Menu "Parameters"

Process

Standstill cooling

Depending on the substances to be centrifuged, it may make sense to precool the centrifuge. The precooling prevents the cooled samples in the uncooled centrifuge from heating up to an inadmissible temperature level.

If the standstill cooling function is activated, the centrifuge starts to precool after it is switched on. In the runtime field, the symbol "❄️" is displayed. The lid must be closed.



CAUTION

Unmoved air in the rotor chamber leads to an incorrect measuring and control behaviour and causes the compressor to freeze over. At temperatures below 0°C, aqueous liquids will freeze, thereby preventing sedimentation.

- Do not cool the rotor below 0°C at a standstill.



NOTE

The centrifuge is equipped with the "RAPID_TEMP" program. This program is used to precool the rotor chamber quickly under defined conditions (see chapter 6.3.2.5 - "Standard menu", Program list).

Radius

The radius determines the value of the relative centrifugal force (RCF) that the sample is subjected to. Normally, the maximum RCF value is displayed. If the value is reduced manually, a downward facing arrow "↓" will be displayed in the RCF field.

6 Using the centrifuge

Density

This setting is useful for glass vessels. If the density of the liquid to be centrifuged is higher than 1.2 g/cm^3 , the value must be adapted manually in order to prevent the glass vessel from breaking. This will reduce the maximum possible final speed (see chapter 2.2.2.2 - "Density"). The reduction will be represented by a downward facing arrow "↓" in the speed field. Values between 1.2 and 10.0 g/cm^3 are possible.

Centrifugation monitoring

The centrifugation monitoring function enables the continuous monitoring of the speed and runtime parameters during the centrifugation.

- Activate the centrifugation monitoring function by clicking.



NOTE

If the function is activated during a centrifugation run, the monitoring process will not be started until the start of the next centrifugation run.

The centrifugation monitoring function compares the speed values of the current run with the reference values that are stored in the control unit. After every run, it issues a corresponding message.

The runtime is considered faulty if the centrifugation run had to be stopped prematurely.

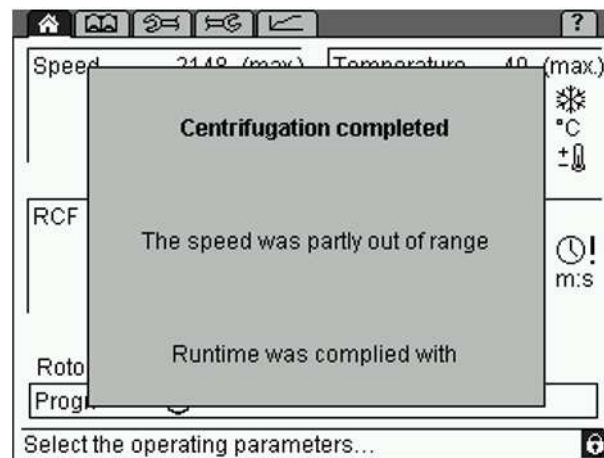

Fig. 17: Example of a centrifugation monitoring message



NOTE

If the centrifugation monitoring system is used in combination with free acceleration or deceleration curves, unjustified error messages may result in certain cases.

6 Using the centrifuge

Temperature monitoring

The control system includes a temperature monitoring function. If the actual temperature difference with regard to the set value deviates from the set temperature difference, the centrifuge will stop and an error message will be issued.

- Activate the temperature monitoring function by clicking.
- Adjust the desired "Delta T" limit value in steps of 1°C or 1°F and confirm the setting.

If the temperature monitoring function is active, the symbol "±" is displayed in the temperature field of the "Standard" menu.

In this case, the centrifuge can only be started if the current temperature is between the preset temperature in the "Standard" menu and the "Delta T" limit value.

If the temperature leaves this range during the centrifugation run, an error message will be displayed and the centrifuge will be decelerated to a complete standstill.



NOTE

The delta T temperature monitoring system remains inactive as long as the "RAPID_TEMP" program is active (see , "Program "RAPID_TEMP"").

Spin-out from...

If this function is active, the brake will be deactivated when the actual speed is below the set speed. As a result, the rotor will spin out in a brakeless manner.



NOTE

A spin-out, in particular with heavy rotors and at high speeds, can take a lot of time! (Depending on the rotor and load, the speed will be reduced by approximately 0.5 to 1 rpm per second.)

If the spin-out is active, "+0" is displayed next to the deceleration curve.

- The spin-out can be interrupted by a quick stop or by restarting the centrifuge.

Lock

In order to prevent any unauthorised use of the centrifuge, the following functions can be blocked:

- Saving of programs (level 01)
- Changing of parameters, short run (level 02)
- Loading of programs (level 03)
- Start button (level 04)

Blocking a function

- Select the function that is to be blocked. The lower levels will also be automatically selected (if, for example, the "Parameters" function is selected, the "Save" function will also be selected).
- Select the button "Activate code".
- Enter a four-digit code and confirm the entry.

The lock is now active. The symbol "🔒" will be displayed in the status line and the lock level will be indicated.

If changes are made after a function has been blocked, the system will ask for the code prior to executing the change.

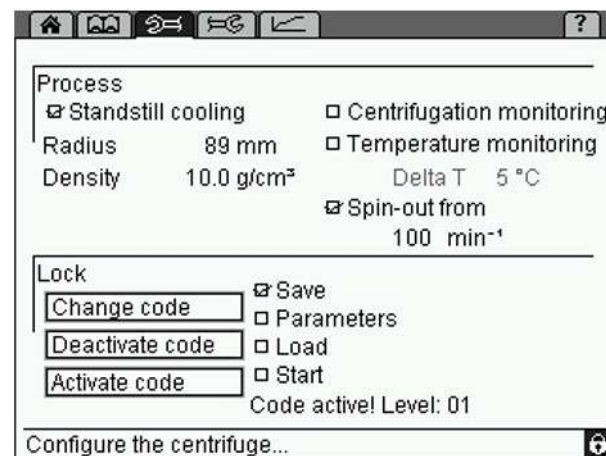

Fig. 18: "Parameters" menu with an active lock (level 01)

Unblocking a function

- Select the button "Deactivate code".
- Enter the code and confirm the entry.

The lock is now deactivated.

Changing the code

- Select the button "Change code".
- Enter the old code and confirm the entry.
- Enter the new code.
- For safety reasons, the code must be entered a second time.

The code is now changed.

6 Using the centrifuge

6.3.2.8 Setup menu

The "Setup" menu is symbolised by the "⚙️" symbol on the menu bar. It is used to perform basic settings concerning the control system of the centrifuge. It enables the optimum adaptation of the centrifuge to its specific area of application.

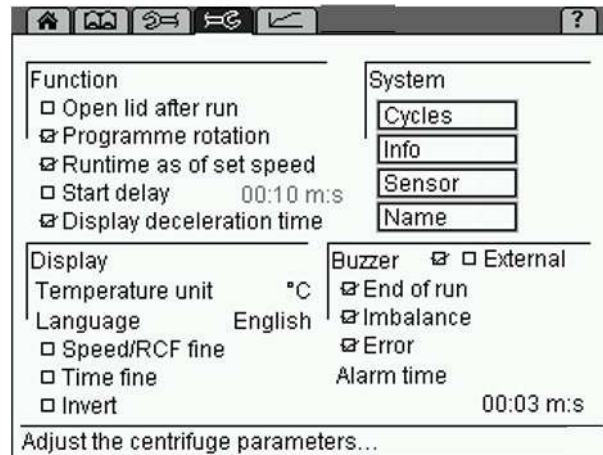

Fig. 19: Menu "Setup"

Function

Open lid after run

The automatic lid opening function ensures that the lid opens when the rotor has stopped.



CAUTION

When the lid is open, the cooling is not active. The sample may warm up!

Program rotation

See chapter 6.3.3.5 - "Automatic program rotation".

Runtime as of set speed

If this function is active, the runtime will not be measured until the set speed is reached. In the "Standard" menu, the symbol "⌚!" will be displayed in the runtime field.



NOTE

In the program mode, this function can be saved separately for every program. In this case, the symbol "⌚!" will be displayed under the runtime of the detailed program description.

6 Using the centrifuge

Start delay

If the start delay function is active, the centrifuge will not start until the preset time has elapsed. The symbol "⌚" will be displayed in the runtime field.

Display deceleration time

In the activated mode, the deceleration time will be displayed instead of the runtime during and after the deceleration process. Below the time display, the symbol "⏻" will be displayed. During a deceleration process, the symbol flashes. Once the deceleration is complete, it is displayed in a permanent manner.

Display

Temperature unit

The temperature can be displayed in °C (Celsius) or °F (Fahrenheit).

Language

The control system can be used in various language versions.

If a language is selected by mistake, it can be changed on any screen as follows:

- Press and hold the stop button.
- Turn the function knob one notch to the left and then one notch to the right.
- Release the stop button. The "Language" window will be displayed.
- Select the desired language.

Speed/RCF fine and Time fine

This menu item can be used to preselect the set speed in steps of 1 rpm (instead of 100 rpm), the RCF value in steps of 1 x g (instead of 10 x g), and the set time in steps of 1 min or 1 sec (instead of 10 min or 10 sec).



NOTE

Regardless of the fine adjustment, the step size increases when the function knob is turned quickly.

Invert

If this function is activated, the display switches from the standard setting with a bright background and dark writing to a dark background with bright writing.

6 Using the centrifuge

System

Cycles

This field shows the number of cycles as well as the runtime of the rotor and buckets that are used.

Info

This item provides information on the software versions that are used in this centrifuge.

Sensor

The sensor mode is reserved for the service personnel.



NOTE

Values can neither be entered nor changed in the menus "Cycles", "Info", and "Sensor".

Name

In this field, an identification will be assigned to the centrifuge.

- The letters and characters can be entered when the cursor flashes in the text field. Turn the function knob in order to select a character and press it to confirm the selection. Then, press the knob again in order to enter the next character. Pressing the arrow button ← will delete the last character. The maximum number of characters is 19.
- When the name is complete, select the option "Accept" and confirm it.

Buzzer (signal)

With this function, a warning sound signal can be selected for

- the end of a centrifugation run,
- an imbalance message,
- an error message.

The duration of the warning signal can be specified.

External

This function is only available if the centrifuge is equipped with the option for the input and output of data (external signal, floating switch) (see chapter 6.3.4 - "Options for data input and output").

6.3.2.9 Curve menu

This menu is used to create and edit customised acceleration and deceleration curves (see chapter 11.3 - "Acceleration and deceleration curves"). It is symbolised by the "⏮" symbol on the menu bar.

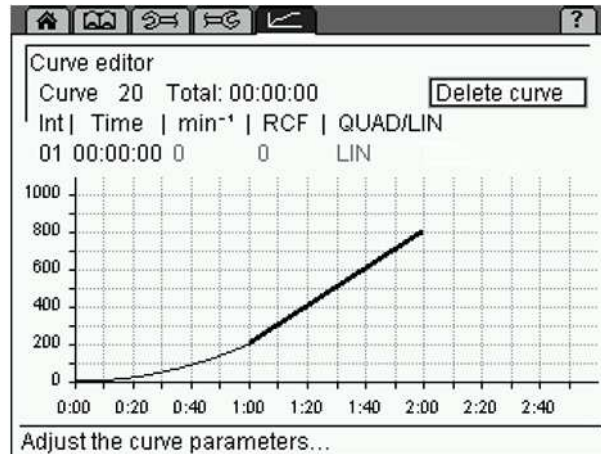

Fig. 20: Menu "Curve"

Creating or changing an acceleration curve

NOTE

During a centrifugation run, curves can only be displayed. They cannot be changed or deleted.

- Select the "Curve" menu. The curve editor will be displayed.
- Select a curve number between 20 and 29 in the input field "Curve". If the curve number is already used, the stored curve will be displayed.
- The input field "Int" is used to specify the interval number of the process. Up to ten intervals can be entered for a curve.
- Enter the interval time of the current interval into the input field "Time". While doing so, certain restrictions must be taken into consideration (see below).
- Enter the desired acceleration under "min⁻¹" (rpm) or "RCF". While doing so, certain restrictions must be taken into consideration (see below). The values are interdependent.
- In the first interval, "QUAD/LIN" can be used to select a linear or quadratic rise. All of the other intervals are linear.

The field "Total" shows the total runtime of the process. The maximum total runtime of a curve depends on the slope of the curve and on the final speed of the rotor.

NOTE

Only the last curve interval can be changed retroactively.

6 Using the centrifuge

Restrictions

- Acceleration and deceleration curves can include intervals with a positive slope as well as intervals with a negative slope and also intervals with 0 slope.
- The slope of the curve intervals can be $1 \text{ min}^{-1}/\text{sec}$ (rpm/sec) minimum and $1000 \text{ min}^{-1}/\text{sec}$ (rpm/sec) maximum.
- Quadratic curve intervals are only possible between 0 and 1000 min^{-1} (rpm) maximum. If a final speed $> 1000 \text{ min}^{-1}$ (rpm) is selected, this interval will automatically become linear above 1000 min^{-1} (rpm).
- The possible runtime results from the maximum possible speed (depending on the rotor) and from the slope limitation.

Example 1: Start speed 0 min^{-1} (rpm), final speed 100 min^{-1} (rpm), runtime 1 hour not possible, since the necessary slope $< 0.03 \text{ min}^{-1}$ (rpm), which means that it is beyond the defined range.

Example 2: Start speed 0 min^{-1} (rpm), final speed 15000 min^{-1} (rpm), runtime 10 sec. not possible, since the necessary slope is 1500 min^{-1} (rpm), which means that it is beyond the defined range.

6.3.2.10 Help menu

The help function is symbolised by the "?" symbol on the menu bar. It provides a short description of the control elements of the selected option.

Activating and deactivating the help function

- Select the question mark on the menu bar and press the function knob.
- Quit the help function by selecting the question mark and by pressing the function knob again.

Parameters can still be changed when the help function is activated.



Fig. 21: Menu "Help"

6.3.2.11 Changing the contrast

To change the contrast:

- Press and hold the stop button and turn the function knob one notch to the left. A dialog box will be displayed once the stop button is released.
- Adjust the contrast of the centrifuge display and confirm the change.

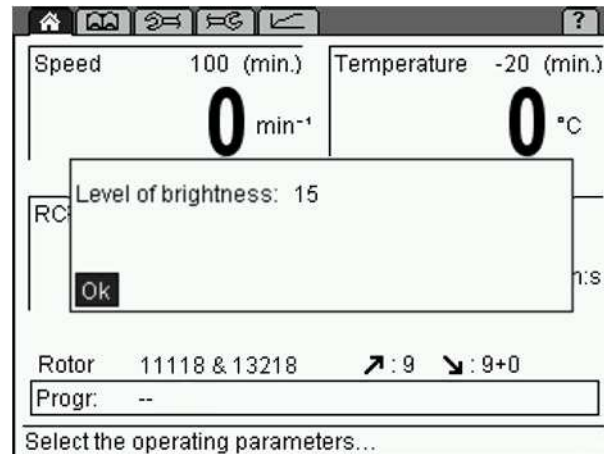

Fig. 22: Dialog box for changing the contrast

6.3.3 Program mode

A program contains all of the data that are required for a centrifuge run. Certain sedimentation results can be repeated under identical conditions. Programs can be loaded, executed, edited, and deleted when the centrifuge is at a standstill.

A maximum of 60 programs can be stored under the numbers 1-60. The program "RAPID_TEMP" does not occupy any storage location and cannot be deleted. It is used to bring the centrifuge to a specific temperature without any vessels.



"--" means that the values that are currently set are not a stored program.

The programs can be protected against unauthorised use, modification, or deletion with the aid of a code (see chapter 6.3.2.7 - "Parameters menu").

Stored programs are listed in the "Process library" menu .

6 Using the centrifuge

6.3.3.1 Saving a program

- Enter the parameters that are to be included in the program.
- Select the option "Progr" in the "Standard" menu  and confirm the selection. The program list will be displayed.
- Select a storage location from the program list.
- Save the program under the desired name. The letters and characters can be entered when the cursor flashes in the text field.
 - Turn the function knob in order to select a letter and press it to confirm the selection. Then, the next character can be selected.
 - Pressing the arrow button  will delete the last character.
- When the program name is complete, select "OK" and confirm it. The program will be saved and the "Standard" menu will be displayed.

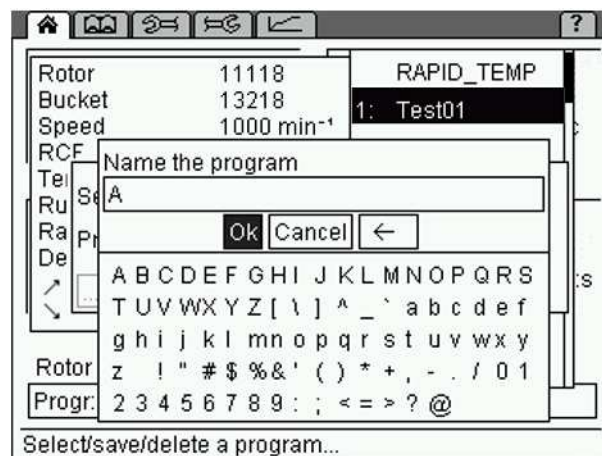



Fig. 23: Assignment of a program name prior to saving the program

6.3.3.2 Loading a program

- Select the option "Progr" from the "Standard" menu  and confirm the selection by pressing the function knob. The program list will be displayed.
 - Select the desired program from the list and confirm the selection by pressing the function knob.
- Or:
- Open the process library , select the desired program, and confirm the selection by pressing the function knob.
- The program will be loaded and the "Standard" menu will be displayed.

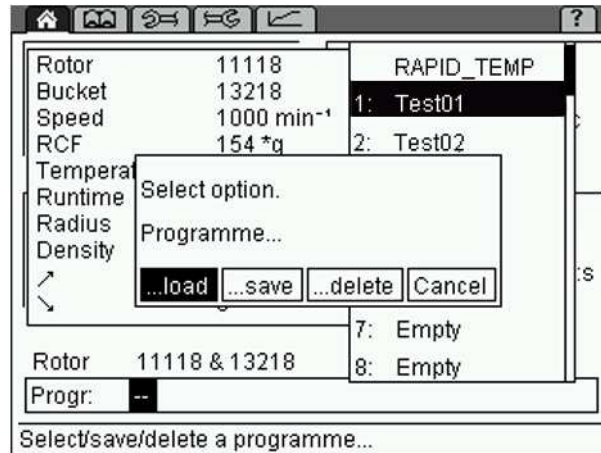



Fig. 24: Loading a program

6.3.3.3 Executing a program

- Select the option "Progr" from the "Standard" menu  and confirm the selection by pressing the function knob. The program list will be displayed.
- Select the desired program from the list and confirm the selection by pressing the function knob.
- Press the start button.

Or:

- Open the process library , select the desired program, and press the start button.

The program will be executed and the "Standard" menu will be displayed.

6.3.3.4 Deleting a program

- Select the option "Progr" in the "Standard" menu  and confirm the selection. The program list will be displayed.
- Select the program that is to be deleted.
- Select the option "Delete" and confirm it.

The program will be deleted and the "Standard" menu will be displayed.

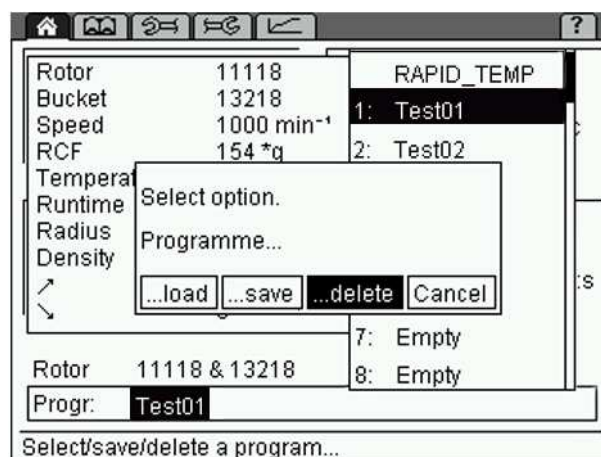

Fig. 25: Deleting a program

6 Using the centrifuge

6.3.3.5 Automatic program rotation

With the automatic program rotation, several programs can be executed directly one after the other.

- Activate the "Program rotation" function in the "Setup" menu

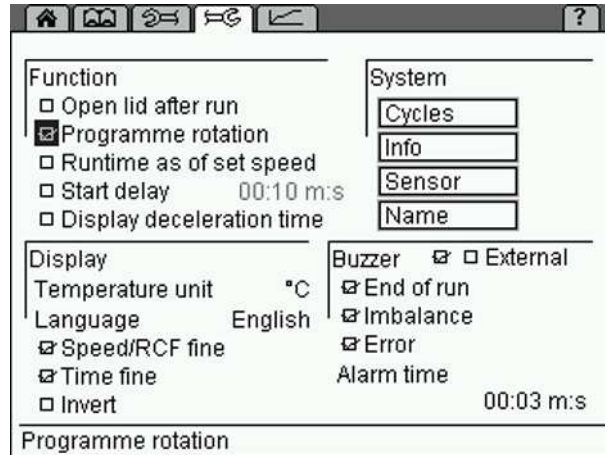

Fig. 26: Program rotation function

When a program is loaded while the program rotation function is active, this program will be used as the start program for the rotation. After the completion of the program, the next program on the program list will be loaded automatically. The rotation continues up to the next empty storage location and then restarts from the beginning (see the following illustration).

Example 1: Loading of Test04

Rotation: Test04, Test05, Test06, Test04,...

Example 2: Loading of Test05

Rotation: Test05, Test06, Test05,...

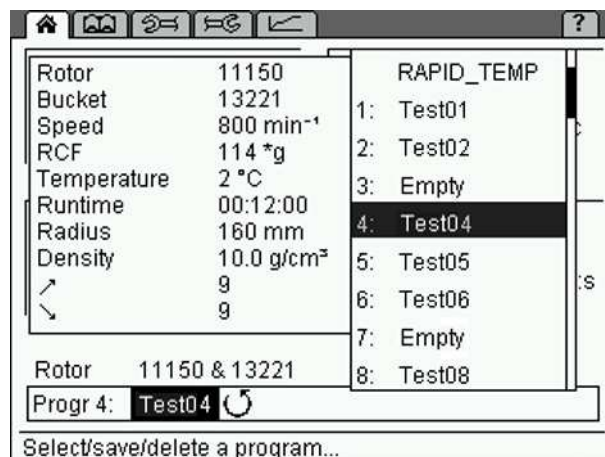

Fig. 27: Automatic program rotation

While the program rotation function is active, the arrow "↻" is displayed in the program line in the "Standard" menu.

6.3.4 Options for data input and output

- Connection for a serial interface (depending on the centrifuge type, partly standard).
- External signal active DC 24V, 0.5 A max. (part no. 17701)
- Floating switch AC 250V max., 6 A (part no. 17702)

6.4 Switching the centrifuge off

- Open the centrifuge when it is not in use so moisture can evaporate.
- Switch the centrifuge off by pressing the mains power switch.

7 Malfunctions and error correction

7 Malfunctions and error correction

7.1 General malfunctions

Malfunctions are indicated by a dialog box. If the acoustic signal is activated, it sounds when the error message is displayed.

- Eliminate the source of the problem (see table below).
- Acknowledge the error messages by pressing the lid key.



NOTE

Error messages can be eliminated by pressing the lid key. The error itself will not be eliminated, but the centrifuge can be operated again.

Type of error	Possible reason	Correction
No indication on the display	No power in the mains supply	Check fuse in the mains supply
	Power cord is not plugged in	Plug in power cord correctly
	Fuses have tripped	Reactivate temperature fuse (see chapter 5.2.1 - "Type of connection")
	Mains power switch off	Switch mains power switch on
Centrifuge cannot be started: start key LED is not illuminated	Several	Power off/on. If the error occurs again, contact service
Centrifuge cannot be started: lid key LED flashes	The lid lock is not closed correctly	Open and close the lid. If the error occurs again, contact service
Centrifuge decelerates during operation	Brief mains power failure	Press start key in order to restart the centrifuge
	System error	Power off/on. If the error occurs again, contact service
Centrifuge decelerates during operation, imbalance dialog box is displayed	<ul style="list-style-type: none"> – Improper loading – Centrifuge is inclined – Drive problem – Centrifuge was moved during run 	Balance load and restart the centrifuge. If the error occurs again, contact service(see chapter 7.1.1 - "Emergency lid release")
	– Ungreased load- bearing bolts	Clean and grease load- bearing bolts
Lid cannot be opened	Lid lock has not released	Unlock the lid manually and contact service
	Lid seal sticks	Clean the lid seal and apply talcum powder
Temperature value cannot be reached (only for refrigerated centrifuges)	Condenser dirty (only air-cooled units)	Clean the condenser. If the error occurs again, contact service

7 Malfunctions and error correction

7.1.1 Emergency lid release

In the event of a power failure, it is possible to manually open the centrifuge lid.

- Switch off the mains power switch and disconnect the power cord from the socket.
- Remove the plug (see figure, item 1) from the opening on the right side panel, e.g. with a screwdriver.



Fig. 28: Position of the opening for the emergency lid release

- First, pull the red string to release the mechanism and then unlock the lid lock by pulling the white string.
- Then, reinsert the plug and quit the error message by switching the centrifuge off/on. Approximately 10 seconds after quitting the lid can be closed again.



WARNING

Do not unlock or open the lid unless the rotor is at a standstill.

If the lid is opened via the emergency lid release system during a centrifuge run, the centrifuge will be switched off immediately and decelerate in an unbraked manner.

7 Malfunctions and error correction

7.2 Table of error codes

Error no.	Kind of error	Measures	Note
1-9	System error	<ul style="list-style-type: none"> Allow to slow down Power off/on 	All these errors stop the centrifuge or cause it to decelerate brakeless
10-19	Speedometer error	<ul style="list-style-type: none"> Allow to slow down Power off/on 	
20-29	Motor error	<ul style="list-style-type: none"> Power off Ensure ventilation 	
30-39	EEPROM error	<ul style="list-style-type: none"> Allow to slow down Power off/on 	With error 34, 35, and 36, the centrifuge will stop; with error 37 and 38 only an error message will be given
40-45	Temperature error (only for refrigerated centrifuges)	<ul style="list-style-type: none"> Allow to slow down Power off Allow to cool down Provide better ventilation (only air cooled centrifuges) Provide sufficient water throughput (only water cooled centrifuges) 	
46-49	Imbalance error	<ul style="list-style-type: none"> Allow to slow down Power off Eliminate the imbalance 	
50-59	Lid error	<ul style="list-style-type: none"> Press lid key Close lid Remove foreign matter from the opening of the lid lock device 	With error 50 and 51, the centrifuge will stop
60-69	Process error	<ul style="list-style-type: none"> Allow to slow down Power off/on 	With error 60 message "power failure during run", with error 61, the message "stop after power on"
70-79	Communication error	<ul style="list-style-type: none"> Allow to slow down Power off/on 	
80-89	Parameter error	<ul style="list-style-type: none"> Power off Allow to cool down Provide for better ventilation 	With error 83, error message only
90-99	Other errors	<ul style="list-style-type: none"> Check connections Provide sufficient water throughput (only water cooled centrifuges) 	



NOTE

If it is impossible to eliminate the errors, contact the service!

7.3 Service contact

In the event of queries, malfunctions, or spare part enquiries:

From Germany:

Contact

Sigma Laborzentrifugen GmbH
An der Unteren Söse 50
37520 Osterode (Germany)
Tel. +49 (0) 55 22 / 50 07-44 44
E-mail: support.lab@sigma-zentrifugen.de

Outside Germany:

Contact our agency in your country. All agencies are listed at
www.sigma-zentrifugen.de → [Sales Partners]



NOTE

- If you would like to utilise our service, please state the type of your centrifuge and its serial number.

8 Maintenance and service

8 Maintenance and service

The centrifuge, rotor, and accessories are subject to high mechanical stress. Thorough maintenance performed by the user extends the service life and prevents premature failure.



CAUTION

If corrosion or other damage occurs due to improper care, the manufacturer cannot be held liable or subject to any warranty claims.

- Use soap water or other water-soluble, mild cleaning agents with a pH value between 6 and 8 for cleaning the centrifuge and accessories (see also).
- Avoid corrosive and aggressive substances.
- Do not use solvents.
- Do not use agents with abrasive particles.
- Do not expose the centrifuge and rotors to intensive UV radiation or thermal stress (e.g. by heat generators).

8.1 Maintenance

8.1.1 Centrifuge

- Unplug the mains power plug before cleaning.
- Carefully remove all liquids, including water and particularly all the solvents, acids, and alkaline solutions from the rotor chamber using a cloth in order to avoid damage to the motor bearings.
- If the centrifuge has been contaminated with toxic, radioactive, or pathogenic substances, clean the rotor chamber immediately with a suitable decontamination agent (depending on the type of contamination).



WARNING

Take suitable precautions for your own safety if there is a risk of toxic, radioactive, or pathogenic contamination.

- Grease the motor shaft slightly after cleaning (grease for load-bearing bolts part no. 70284).

8.1.2 Condenser (only refrigerated centrifuges)

In order to cool the refrigerant that is compressed by the refrigeration unit, a lamellar condenser is used. It is cooled by air.

Dust and dirt obstruct the cooling flow of air. The dust on condenser pipes and lamellas reduces the heat exchange and thus the performance of the refrigeration unit.

This is why the installation site should be as clean as possible.

- Check the condenser at least once a month for dirt and clean it if necessary.
- If you have any queries, please contact service (see chapter 7.3 - "Service contact").

8.1.3 Accessories



CAUTION

For the care of the accessories, special safety measures must be considered as these are measures that will ensure operational safety at the same time!

- Immediately rinse off the rotor, buckets, or accessories under running water if they have come into contact with any liquids that may cause corrosion. Use a brush for test tubes in order to clean the bores of angle rotors. Turn the rotor upside down and allow it to dry completely.
- Clean the accessories outside the centrifuge once a week or preferably after each use. Adapters should be removed, cleaned and dried.



CAUTION

Do not clean the accessories in a dishwasher!

Cleaning in a dishwasher removes the anodised coating; the result is cracking in areas that are subject to stress.

- If the rotors or accessories have been contaminated with toxic, radioactive, or pathogenic substances, clean them immediately with a suitable decontamination agent (depending on the type of contamination). Take suitable precautions for your own safety if there is a risk of toxic, radioactive, or pathogenic contamination.
- Dry the accessories with a soft cloth or in a drying chamber at approx. 50°C.

8 Maintenance and service

8.1.3.1 Plastic accessories

The chemical resistance of plastic decreases with rising temperatures (see chapter 11.5 - "Resistance data").

- If solvents, acids, or alkaline solutions have been used, clean the plastic accessories thoroughly.



WARNING

Plastic accessories must not be greased!

8.1.4 Rotors, buckets and carriers

Rotors, buckets and carriers are produced with the highest precision, in order to withstand the permanent high stress from high gravitational fields. Chemical reactions as well as stress-corrosion (combination of oscillating pressure and chemical reaction) can affect or destroy the metals. Barely detectable cracks on the surface can expand and weaken the material without any visible signs.

- Check the material regularly (at least once a month) for
 - cracks
 - visible damage of the surface
 - pressure marks
 - signs of corrosion
 - other changes.
- Check the bores of the rotors and multiple carriers.
- Replace any damaged components immediately for your own safety.
- Grease the rotor tie-down screw after cleaning with grease for load bearing bolts (part no. 70284) and spread the grease with a cloth.

8.1.5 Load bearing bolts

Only greased load bearing bolts ensure the even swinging of the buckets and, therefore, the quiet run of the centrifuge. Non-greased bolts can lead to a system shut-down due to imbalances.

Apply a small quantity of grease (part no. 70284) to the load bearing bolts of the rotor and buckets after each cleaning.

8.1.6 Glass breakage**CAUTION**

In the case of glass breakage, immediately remove all glass particles (e.g. with a vacuum cleaner). Replace the rubber cushions since even thorough cleaning will not remove all glass particles.

Glass particles will damage the surface coating (e.g. anodising) of the buckets, which will then lead to corrosion.

Glass particles in the rubber cushions of the buckets will cause glass breakage again.

Glass particles on the pivot bearing of the load-bearing bolts prevent the buckets and carriers from swinging evenly, which will cause an imbalance.

Glass particles in the rotor chamber will cause metal abrasion due to the strong air circulation. This metal dust will not only pollute the rotor chamber, rotor, and materials to be centrifuged but also damage the surfaces of the accessories, rotors, and rotor chamber.

In order to completely remove the glass particles and metal dust from the rotor chamber:

- Grease the upper third of the rotor chamber with e.g. Vaseline.
- Then, let the rotor rotate for a few minutes at a moderate speed (approx. 2000 rpm). The glass and metal particles will now collect at the greased part.
- Remove the grease with the glass and metal particles with a cloth.
- If necessary, repeat this procedure.

8.2 Sterilisation and disinfection of the rotor chamber and accessories

- Use commercially-available disinfectants such as, for example, Sagrotan[®], Buraton[®], or Terralin[®] (available at chemist's shops or drugstores).
- The centrifuge and the accessories consist of various materials. A possible incompatibility must be considered.
- Before using cleaning or decontamination agents that were not recommended by us, contact the manufacturer to ensure that such a procedure will not damage the centrifuge.
- For autoclaving, consider the continuous heat resistance of the individual materials (see chapter 8.2.1 - "Autoclaving").

Please contact us if you have any queries (see chapter 7.3 - "Service contact").

**DANGER**

If dangerous materials (e.g. infectious and pathogenic substances) are used, the centrifuge and accessories must be disinfected.

8 Maintenance and service

8.2.1 Autoclaving

The service life of the accessories essentially depends on the frequency of autoclaving and use.

- Replace the accessories immediately when the parts show changes in colour or structure or in the occurrence of leaks etc.
- During autoclaving, the caps of the tubes must not be screwed on in order to avoid the deformation of the tubes.



NOTE

It cannot be excluded that plastic parts, e.g. lids or carriers, may deform during autoclaving.

Accessories	Max. temp. (°C)	Min. time (min)	Max. time (min)	Max. cycles
Aluminium buckets	134-138	3	5	-
Aluminium rotors	134-138	3	5	-
Glass tubes	134-138	3	40	-
Polyallomer / polycarbonate rectangular carriers	115-118	30	40	-
Polyallomer / polycarbonate round carriers	115-118	30	40	-
Polyamide buckets	115-118	30	40	10
Polycarbonate / polyallomer lids for angle rotors	115-118	30	40	20
Polycarbonate tubes	115-118	30	40	20
Polyphenylsulfone (PPSU) caps for buckets	134-138	3	5	100
Polypropylene balance adapter for blood-bag systems	115-118	30	40	n.s.
Polypropylene copolymer tubes	115-121	30	40	20
Polypropylene rectangular carriers	115-118	30	40	-
Polypropylene rotors	115-118	30	40	20
Polypropylene round carriers	115-118	30	40	-
Polysulfone caps for buckets	134-138	3	5	100
Polysulfone lids for angle rotors	134-138	3	5	100
Rubber adapters	115-118	30	40	-
Stainless-steel balance weight for blood-bag systems	121	30	30	n.s.
Teflon tubes	134-138	3	5	100

8.3 Service

**DANGER**

In the event of service work that requires the removal of the panels, there is a risk of electric shock or mechanical injury. Only qualified specialist personnel is authorised to perform this service work.

The centrifuge is subject to high mechanical stress. In order to be able to withstand this high level of stress, high-quality components were used during the production of the centrifuge. Nevertheless, wear cannot be excluded and it may not be visible from the outside. Especially the rubber parts that are – among other things – part of the motor suspension, are subject to ageing.

This is why we recommend having the centrifuge checked by the manufacturer during an inspection once per year in the operating state and once every three years in the dismantled state. Rubber parts should be replaced after three years.

Information and appointments:

In Germany:

Contact

Sigma Laborzentrifugen GmbH

An der Unteren Söse 50

37520 Osterode (Germany)

Tel. +49 (0) 55 22 / 50 07-44 44

E-mail: support.lab@sigma-zentrifugen.de

Outside Germany:

Contact our agency in your country. All agencies are listed at www.sigma-zentrifugen.de → [Sales Partners]

**NOTE**

- If you would like to utilise our service, please state the type of your centrifuge and its serial number.

8 Maintenance and service

8.4 Return of defective parts

Although we exercise great care during the production of our products, it may be necessary to return a unit or accessory to the manufacturer.

In order to ensure the quick and economical processing of returns of centrifuges, spare parts, or accessories, we require complete and extensive information concerning the process. Please fill in the following forms completely, sign them, enclose them with the return package, and send them together with the product to:

Sigma Laborzentrifugen GmbH
An der Unteren Söse 50
37520 Osterode (Germany)

1. Declaration of decontamination

As a certified company and due to the legal regulations for the protection of our employees and of the environment, we are obliged to certify the harmlessness of all incoming goods. For this purpose, we require a declaration of decontamination.

- The form must be filled in completely and signed by authorised and specialised personnel only.
- Affix the original form in a clearly visible manner to the outside of the packaging.



NOTE

We will return the unit if no declaration of decontamination is provided!

2. Form for the return of defective parts

This form is for the product-related data. They facilitate the assignment, and they enable the quick processing of the return. If several parts are returned together in one packaging, please enclose a separate problem description for every defective part.

- A detailed problem description is necessary in order to perform the repair quickly and economically.



NOTE

If the form does not include a description of the malfunction, neither a refund nor a credit note can be issued. In this case, we reserve the right to return the parts to you at your expense.

- Upon request, we will prepare and submit to you a cost estimate prior to performing the repair. Please confirm such cost estimate within 14 days. If the cost estimate has still not been confirmed after 4 weeks, we will return the unit. Please note that you must bear the incurred costs.

8 Maintenance and service



The unit must be packaged in a transport-safe manner. Please use the original packaging, if at all possible.
If the product is dispatched to us in unsuitable packaging, you will be charged the cost for returning it to you in new packaging.

The forms can be downloaded online from
www.sigma-zentrifugen.de → [Service] → [Overhaul and repair].

9 Disposal

9 Disposal

9.1 Disposal of the centrifuge



In accordance with the directive 2002/96/EC, SIGMA centrifuges are marked with the symbol shown to the left. This symbol means that it is not permissible to dispose of the unit among household waste.

- You can return these centrifuges free of cost to Sigma Laborzentrifugen GmbH.
- Ensure that the unit is decontaminated. Fill in a declaration of decontamination (see chapter 8.4 - "Return of defective parts").
- Comply with any other applicable local rules and regulations.

9.2 Disposal of the packaging

- Use the packaging to return the centrifuge for disposal or
- dispose of the packaging, after having separated the individual materials.
- Comply with all local rules and regulations.

10 Technical data

Manufacturer	Sigma Laborzentrifugen GmbH An der Unteren Söse 50 37520 Osterode (Germany)
Type:	3-18KS
<u>Connection requirements</u>	
Electr. connection:	see name plate
Protection class:	I
IP code:	20
Connected load (kVA):	1.35
Power consumption (kW):	1.01
Max. current consumption (A):	5.50 (at 220-240 V / 50 Hz)
Input fuse (AT):	16.0 (at 220-240 V / 50 Hz), temperature fuses
<u>Performance data</u>	
Max. speed (rpm):	18,000
Max. capacity (ml):	1,600
Max. gravitational field (x g):	30,070
Max. kin. energy (Nm):	22,997
<u>Other parameters</u>	
Time range:	10 sec – 99 h 59 min, short run, continuous run
Temperature range:	-20°C to +40°C
Storage locations:	60
<u>Physical data</u>	
Height (mm):	355
Height with open lid (mm):	785
Width (mm):	630
Depth (mm):	600
Weight (kg):	78
Noise level (dB(A)):	66 (at maximum speed)

10.1 Ambient conditions

- The figures are valid for an ambient temperature of $+23^{\circ}\text{C} \pm 2^{\circ}\text{C}$ and a nominal voltage $\pm 10\%$. The minimum temperature is $< +4^{\circ}\text{C}$ and depends on the rotor type, speed, and ambient temperature.

NOTE

At a nominal voltage of 100V or 200V, a tolerance of $+10\%$ / -5% applies.

- For indoor use only.
- Allowable ambient temperature $+5^{\circ}\text{C}$ to $+35^{\circ}\text{C}$.
- Max. relative humidity of air 80% up to 31°C with a linear decrease to 67% relative humidity of air at 35°C .
- Maximum altitude 2,000 m above sea level.

10 Technical data

10.2 Technical documentation

For environmental reasons, the comprehensive technical documentation of the centrifuge (e.g. circuit diagrams) and the safety data sheets of the manufacturers of refrigerant and lubricants are not attached to this documentation.

You can order these documents from our service department.

11 Appendix

11.1 Range of accessories

Part no.	Description	Max. speed (rpm)	Max. gravitational field (x g)
11132	Swing-out rotor 28 x 15 ml complete, no. 11133, incl. 2 sets buckets no. 13104, 2 sets round carriers no. 17015 and 28 PP-tubes 15 ml no. 15023 Radius max. 15.5 cm, radius min. 4.5 cm	5 500	5 242
11133	Swing-out rotor, 4 place, for buckets no. 13104, 13130	5 500	
11135	Swing-out rotor 24 x 1.5/2.0 ml, incl. 3 sets buckets no. 13124, for e.g. reaction vials no. 15008, 15040, incl. hermetic aluminium lid no. 17879 Radius max. 7.4 cm, radius min. 3.5 cm	14 000	16 215
11136	Drum rotor for 6 cassettes no. 14000, 14002, 14020, 14021, for reaction vials (max. 60/192 pcs.), incl. hermetic aluminium lid no. 17898 Radius max. 7.0 cm, radius min. 3.0 cm Attention: The vessels could be damaged at speeds exceeding 13,000 rpm!	14 500	16 454
11180	Swing-out rotor, 4 place, for buckets no. 13180, 13190, 13194	4 700	
11181	Swing-out rotor 48 x 15 ml complete, no. 11180, incl. 2 sets rectangular buckets no. 13180, 2 sets rectangular carriers no. 18015 and 48 PPCO-tubes 15 ml no. 15023 Radius max. 17.1 cm, radius min. 7.6 cm	4 700	4 223
11182	Swing-out rotor 12 x 50 ml culture tubes complete, no. 11180, incl. 2 sets buckets no. 13190, 2 sets adapters no. 17346 and 12 tubes no. 15151 Radius max. 17.2 cm, radius min. 7.5 cm	4 700	4 248
11222	Swing-out rotor for microtiter plates, incl. 1 set carriers no. 13222, max. height of plates 56 mm, max. load per bucket approx. 335 gram Radius max. 12.1 cm, Radius min. 4.8 cm	3 000	1 218
11224	Swing-out cytology rotor complete, incl. 2 sets buckets no. 13224, 4 inserts no. 15223. The buckets with the object carriers could be locked in 90° position. Radius max. 11.3 cm, radius min. 6.9 cm	3 000	1 137
11241	Swing-out rotor for microtiter plates, Biosafe with certificate, incl. 1 set buckets no. 13241, 1 set caps 17108 and plate holder no. 17982 max. height of plates 55 mm, without cap 17108 max. 66 mm, max. load per bucket approx. 290 g Radius max. 13.3 cm, radius min. 4.4 cm	4 700	3 285
12111	Angle rotor 10 x 10 ml, for tubes no. 15000, 15010, 15039, incl. hermetic aluminium lid no. 17835 Radius max. 7.6 cm, radius min. 2.8 cm, angle 35°	18 000	27 530
12115	Angle rotor, for 12 PCR-strips with 8 tubes 0.2 ml, e.g. no. 15042, incl. hermetic aluminium lid no. 17875 Radius max. 9.8 cm, radius min. 7.2 cm, angle 45°	16 400	29 468
12131	Angle rotor 30 x 1.5/2.0 ml, for e.g. reaction vials no. 15008, 15040, incl. hermetic aluminium lid no. 17848 Radius max. 10.0 cm, radius min. 6.7 cm, angle 45°	16 400	30 070
12150	Angle rotor 6 x 50 ml, for tubes e.g. no. 13055, 15051, 15052, incl. hermetic aluminium lid no. 17837 Radius max. 8.4 cm, radius min. 2.1 cm, angle 25°	14 600	20 018

11 Appendix

Part no.	Description	Max. speed (rpm)	Max. gravitational field (x g)
12154	Angle rotor 24 x 1.5/2.0 ml, for e.g. reaction vials no. 15008, 15040, incl. hermetic aluminium lid no. 17829 Radius max. 8.2 cm, radius min. 5.0 cm, angle 45°	18 000	29 703
12155	Angle rotor 4 x 80/85 ml, for tubes e.g. no. 13085, 15076, 15080, incl. hermetic aluminium lid no. 17839 Radius max. 9.1 cm, radius min. 1.4 cm, angle 26°	14 500	21 390
12156	Angle rotor 8 x 50 ml, for tubes e.g. no. 13055, 15051, 15052, incl. hermetic aluminium lid no. 17840 Radius max. 9.6 cm, radius min. 3.3 cm, angle 25°	13 800	20 440
12157	Angle rotor 20 x 10 ml, for tubes e.g. no. 15000, 15010, 15039, incl. hermetic aluminium lid no. 17841 Radius max. 9.8 cm, radius min. 5.8 cm, angle 25°	10 000	10 956
12158	Angle rotor 6 x 30 ml, for tubes e.g. no. 15029, 15030, 15032, incl. hermetic aluminium lid no. 17842 Radius max. 7.9 cm, radius min. 2.1 cm, angle 29°	18 000	28 616
12159	Angle rotor 6 x 85 ml, for tubes e.g. no. 13085, 15076, 15080, incl. hermetic aluminium lid no. 17843 Radius max. 9.8 cm, radius min. 2.8 cm, angle 25°	11 400	14 239
12171	Angle rotor for 12 x 15 ml culture tubes, e.g. no. 15115, incl. hermetic aluminium lid no. 17872 Radius max. 9.9 cm, radius min. 4.3 cm, angle 25°	13 500	20 172
12182	Angle rotor 12 x 5 ml, Eppendorf reaction caps, incl. hermetic aluminium lid no. 17182 (software version 50 or higher) Radius max. 8.4 cm, radius min. 4.3 cm	17 500	28 761
12349	Angle rotor 48 x 1.5/2.0 ml, for reaction vials, e.g. no. 15008, 15040, incl. hermetic lid 17349 Radius max. 10.0 cm, radius min. 6.5 cm	15 000	25 155
19776	Angle rotor for 6 x 50 ml culture tubes, e.g. no. 15151, incl. hermetic aluminium lid no. 17831	14 000	20 379
13104	Round bucket, sealable with caps no. 17109 or 17111, suitable for round carriers Ø 56.5 no. 17006 - 17101 and bottles 200 ml no. 15202, max. tube length 110 mm, 1 set = 2 pcs. Radius max. 15.5 cm, radius min. 4.5 cm	5 500	5 242
13130	Bucket, suitable for 3 culture tubes 15 ml no. 15115, sealable with cap no. 17109, 17111, 1 set = 2 pcs. Radius max. 16.0 cm, radius min. 4.0 cm	5 500	5 411
13180	Rectangular bucket, for rectangular carriers no. 18002 - 18200, sealable with cap no. 17112, max. tube length 115 mm, 1 set = 2 pcs. Radius max. 17.1 cm, radius min. 7.6 cm	4 700	4 223
13190	Round bucket, suitable for round carriers Ø 85 mm no. 17344 - 17400 and 400 ml bottle no. 15401, Biosafe sealable with cap no. 17190, max. tube length 110 mm, 1 set = 2 pcs. Radius max. 17.2 cm, radius min. 7.5 cm	4 700	4 248
13194	Bucket for hexagon adapters no. 18309 - 18312, for culture tubes 15 and 50 ml, 1 set = 2 pcs. Radius max. 16.8 cm, radius min. 6.6 cm	4 700	4 149
13241	Bucket for microtiter plates, Biosafe certificate, closeable with cap 17108, max. height of plates 55 mm with cap 17108, 66 mm without cap 17108, incl. plateholder no. 17982, 1 set = 2 pcs. Radius max. 13.3 cm, radius min. 4.4 cm	4 700	3 285

Adapters and stainless steel tubes

Part no.	Description
13000	Adapter for reaction vials 0.25/0.4 ml no. 15014, suitable for 12110, 12131, 12154, 12349, 1 Set = 2 pcs.
13002	Adapter for reaction vials 0.5/0.75 ml, Ø 7.9/10 x 28/31 mm, e.g. no. 15005, suitable for 12110, 12131, 12154, 12349, 1 set = 2 pcs.
13021	Adapter for PCR-tube 0.2 ml, 1 set = 2 pcs., suitable for 12110, 12131, 12154, 12349, 14002, 17008, 18002
13055	Stainless steel tube 50 ml, Ø 28.5 x 101.5 mm, sealable with cap no. 17054, suitable for 12150, 12156, 13082
13059	Adapter for 1 round bottom tube 10 ml, max. Ø 16.2/19 x 75 - 85 mm, e.g. no. 15000, 15010, 15039, 1 set = 2 pcs.
13060	Adapter for 1 culture tube 15 ml no. 15115, 1 set = 2 pcs.
13062	Adapter for 1 Greiner tube 15 ml, Ø 17/22 x 95 - 100 mm, 1 set = 2 pcs., suitable for 12150
13079	Bottom adapter for 1 tube 50 ml, e.g. no. 15051, 15052, 1 set = 2 pcs.
13080	Adapter for 1 culture tube 50 ml, e.g. no. 15151, 1 set = 2 pcs.
13081	Adapter for 1 culture tube 15 ml, e.g. no. 15115, 1 set = 2 pcs.
13082	Adapter for 1 tube 50 ml, max. Ø 28.8 x 105 - 115 mm, e.g. no. 13055, 15051, 15052, 1 set = 2 pcs.
13083	Adapter for 1 tube 30 ml, max. Ø 25.5 x 90 - 100 mm, e.g. no. 15029, 15030, 15032, 1 set = 2 pcs.
13084	Adapter, for 2 tubes 10 ml, Ø 16/17.5 x 75 - 90 mm, e.g. no. 15000, 15010, 15039, 1 set = 2 pcs.
13085	Stainless steel tube 85 ml, Ø 38 x 103 mm, sealable with cap no. 17185, suitable for 12155, 12159
13255	Stainless steel bottle 250 ml, Ø 61.4 x 125 mm, sealable with cap no. 17256

The complete list of accessories can be downloaded from www.sigma-zentrifugen.de.

11 Appendix

11.1.1 Maximum speed for tubes

Some tubes, such as centrifuge glass tubes, microtubes, culture tubes, fluoropolymer tubes and especially high-volume tubes can be used in our rotors, buckets, and adapters at higher speeds than their breaking limit.

- Always fill the tubes up to their useful volume (= the volume that is stated for the tube).
- When using glass tubes, the maximum value of 4,000 x g must not be exceeded (except special high-strength glass tubes; please refer to the information provided by the manufacturer).

11.1.2 Rotor radii

The information in the accessories table concerning the radius refers to the values of the respective rotor as shown below. The radius calculation is described in chapter 2.2.2.1 - "Speed, radius, and relative centrifugal force".

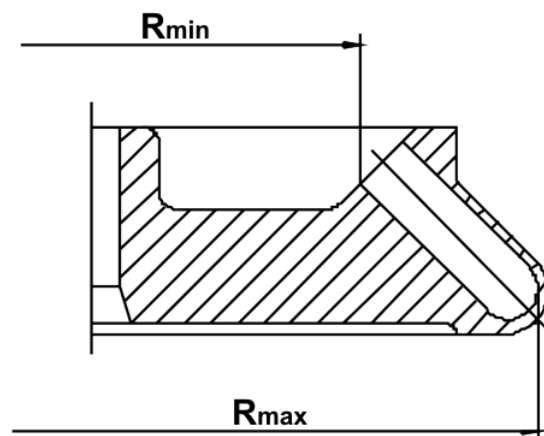

Fig. 29: Minimum and maximum radius of an angle rotor

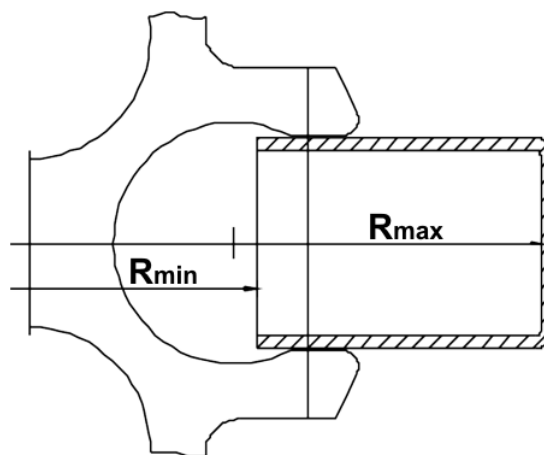

Fig. 30: Minimum and maximum radius of a swing-out rotor

11.2 Speed-gravitational-field-diagram

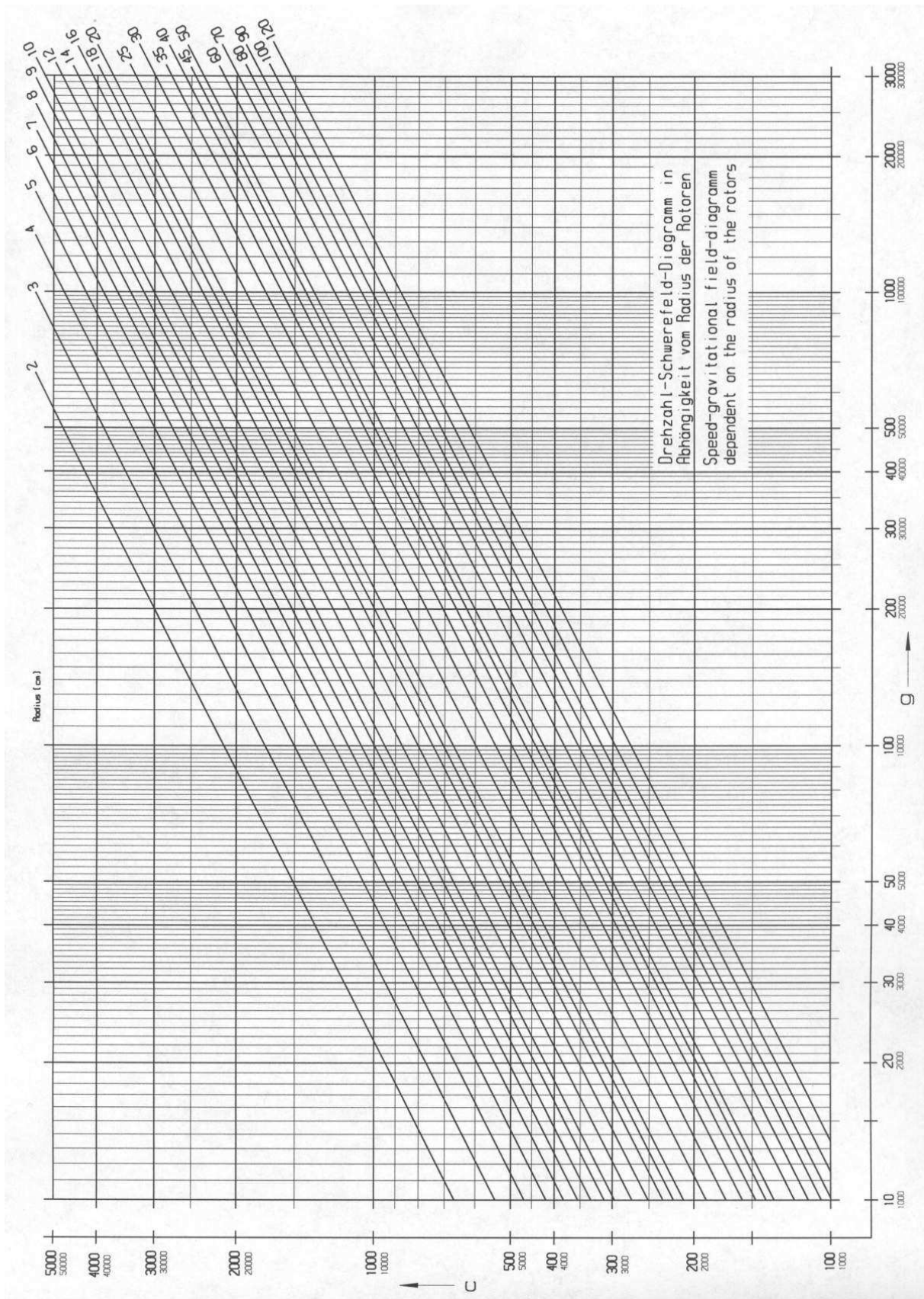

Fig. 31: Speed-gravitational-field-diagram

11 Appendix

11.3 Acceleration and deceleration curves

Linear as well as quadratic curves are numbered in the direction of increasing acceleration (from right to left).

The deceleration curves are inverted images of the acceleration curves and are assigned the same numbers. An exception is curve 0. It decelerates brakeless (spin-out).

In general, the runtime, until the set speed is reached, depends on the moment of inertia of the rotor.

Linear curves

The slope of the fixed acceleration curves defines the time that is required to accelerate the rotor by 1,000 rpm.

Curve 9 is a special case compared to the other curves. The centrifuge accelerates with maximum power. The runtime, until the set speed is reached, depends solely on the moment of inertia of the rotor.

Linear curve no.	Slop
0	4 [rpm/sec]
1	6 [rpm/sec]
2	8 [rpm/sec]
3	17 [rpm/sec]
4	25 [rpm/sec]
5	33 [rpm/sec]
6	50 [rpm/sec]
7	100 [rpm/sec]
8	200 [rpm/sec]
9	1.000 [rpm/sec]

Fig. 32: Slope of linear curves

Quadratic curves

Curve 19 is a special case compared to the other curves. The centrifuge accelerates with maximum power. The runtime depends solely on the moment of inertia of the rotor.

Quadratic curve no.	Time until 1,000 rpm	Slope as of 1,000 rpm
10	500 sec	4 [rpm/sec]
11	333 sec	6 [rpm/sec]
12	250 sec	8 [rpm/sec]
13	118 sec	17 [rpm/sec]
14	80 sec	25 [rpm/sec]
15	60 sec	33 [rpm/sec]
16	40 sec	50 [rpm/sec]
17	20 sec	100 [rpm/sec]
18	10 sec	200 [rpm/sec]
19	2 sec	1.000 [rpm/sec]

Fig. 33: Slope of quadratic curves

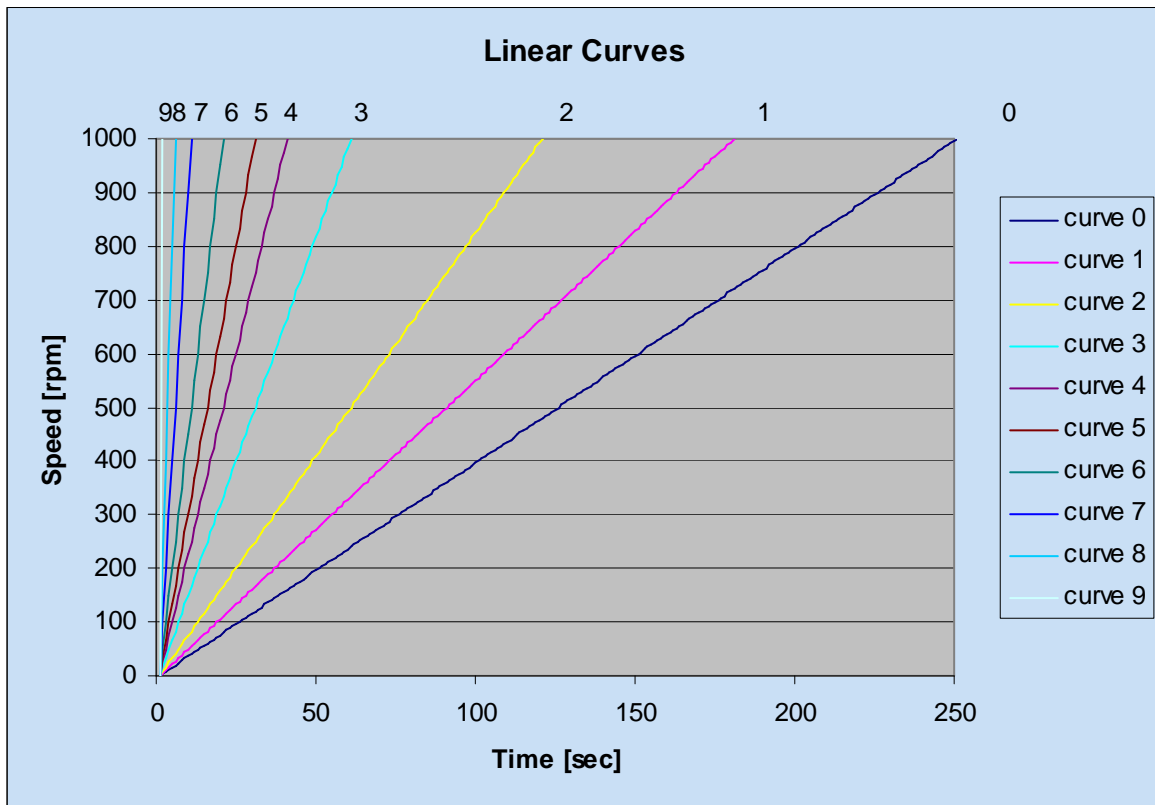

Fig. 34: Diagram of linear curves

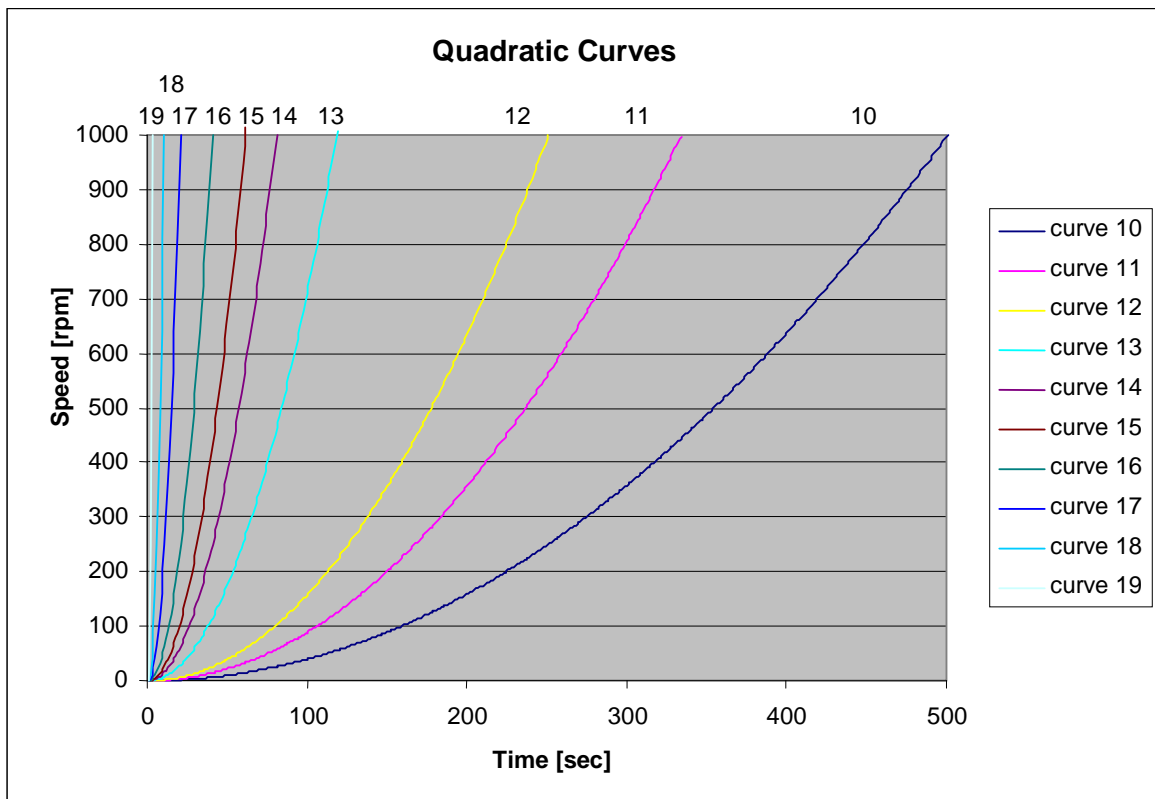



Fig. 35: Diagram of quadratic curves

11 Appendix

11.4 Table of the service life of rotors and accessories

Rotors and accessories with a different service life					
If no other data concerning the service life are engraved on the rotor or accessory, rotors and buckets must be checked by the manufacturer after 10 years. After 50,000 cycles, rotors must be scrapped for safety reasons.					
Rotor / bucket	Cycles	Service life ("Exp.Date")	Autoclaving	Suitable for centrifuge	Remarks
9100	15,000			4-15C, 4K15C, 4-16, 4-16S, 4-16K, 4-16KS, 6-15, 6K15, 6-16, 6-16K	without engraving, only "spincontrol professional" and "spincontrol S"
11026		7 years		1-14, 1-14K	
12033		5 years		1-16 Edition, 1-16K Edition	
12082		7 years		1-14, 1-14K	
12083		7 years		1-14, 1-14K	
12084		7 years		1-14, 1-14K	
12085		7 years		1-14, 1-14K	
12092		5 years	20x	1-14, 1-14K	
12093		5 years	20x	1-14, 1-14K	
12094		5 years	20x	1-14, 1-14K	
12096		5 years	20x	1-14, 1-14K	
12101		5 years	20x	1-15, 1-15K, 1-15P, 1-15PK	
12124		5 years	20x	1-15, 1-15K, 1-15P, 1-15PK	
12126		5 years	20x	1-15, 1-15K, 1-15P, 1-15PK	
12134		5 years	20x	1-16, 1-16K	
12135		5 years	20x	1-16, 1-16K	
12137		5 years	20x	1-16, 1-16K	
12500		7 years		6-15, 6K15, 6-16, 6-16K	
12600		7 years		6-16S, 6-16KS	
13218	20,000			4-16, 4-16S, 4-16K, 4-16KS, 6-16, 6-16S, 6-16K, 6-16KS	
13296		5 years	10x	2-6, 2-6E, 2-7	
13299		5 years	10x	2-6, 2-6E, 2-7, 2-16P, 2-16KL, 2-16KHL	
13635	25,000			6-16, 6-16K, 6-16S, 6-16KS	
13845	20,000			8K, 8KS	
13850	10,000			8K, 8KS, 8KBS	
13860	35,000			8K, 8KS, 8KBS	
13864	1,000			8K, 8KS	without engraving
13865	1,000			8K, 8KS	without engraving
13866	1,000			8K, 8KS	without engraving

11.5 Resistance data

NOTE

The data refer to resistance at 20°C.

- no data 1 resistant 2 practically resistant 3 partially resistant 4 not resistant	Concentration	High Density Polyethylene	Polyamide	Polycarbonate	Polyoxymethylene	Polypropylene	Polysulfone	Polyvinyl chloride, hard	Polyvinyl chloride, weak	Polytetrafluorethylene	Acrylonitrile-butadiene-caoutchouc	Aluminium	
													Medium
Acetaldehyde	C ₂ H ₄ O	40	3	2	4	2	3	4	4	-	1	4	1
Acetamide	C ₂ H ₅ NO	saturated	1	1	4	1	1	4	4	-	1	-	1
Acetone	C ₃ H ₆ O	100	1	1	4	1	1	4	4	-	1	4	1
Acrylonitrile	C ₃ H ₃ N	100	1	1	4	3	3	4	4	4	1	4	1
Allyl alcohol	C ₃ H ₆ O	96	1	3	3	2	2	2	2	4	1	1	1
Aluminium chloride	AlCl ₃	saturated	1	3	2	4	1	-	1	-	1	1	4
Aluminium sulfate	Al ₂ (SO ₄) ₃	10	1	1	1	3	1	1	1	1	1	1	1
Ammonium chloride	(NH ₄)Cl	aqueous	1	1	1	2	1	1	1	1	1	1	3
Ammonium hydroxide	NH ₃ + H ₂ O	30	1	3	4	1	1	2	1	-	1	-	1
Aniline	C ₆ H ₇ N	100	1	3	4	1	2	4	4	4	1	4	1
Anisole	C ₇ H ₈ O	100	3	4	4	1	4	4	2	-	1	4	1
Antimony trichloride	SbCl ₃	90	1	4	1	4	1	-	1	-	1	-	4
Benzaldehyde	C ₇ H ₆ O	100	1	3	4	1	1	3	4	4	1	4	1
Benzene	C ₆ H ₆	100	3	2	4	1	3	4	4	-	1	4	1
Boric acid	H ₃ BO ₃	aqueous	1	3	1	2	1	-	-	-	1	1	1
Butyl acrylate	C ₇ H ₁₂ O ₂	100	1	2	4	2	3	4	4	4	1	-	1
Butyl alcohol, normal	C ₄ H ₁₀ O	100	1	1	2	1	1	2	2	4	1	1	1
Calcium chloride	CaCl ₂	alcoholic	1	4	2	3	1	-	-	4	1	1	3
Carbon disulfide	CS ₂	100	4	3	4	2	4	4	4	4	1	3	1
Carbon tetrachloride (TETRA)	CCl ₄	100	4	4	4	2	4	4	4	4	1	3	1
Chlorine	Cl ₂	100	4	4	4	4	4	4	4	4	1	-	3
Chlorine water	Cl ₂ x H ₂ O		3	4	4	4	3	-	3	3	1	-	4
Chlorobenzene	C ₆ H ₅ Cl	100	3	4	4	1	3	4	4	4	1	4	1
Chloroform	CHCl ₃	100	3	3	4	4	3	4	4	4	1	4	3

11 Appendix

- no data 1 resistant 2 practically resistant 3 partially resistant 4 not resistant	Medium	Formula	Concentration [%]	High Density Polyethylene	Polyamide	Polycarbonate	Polyoxymethylene	Polypropylene	Polysulfone	Polyvinyl chloride, hard	Polyvinyl chloride, weak	Polytetrafluorethylene	Acrylonitrile-butadiene- caoutchouc	Aluminium
				HDPE	PA	PC	POM	PP	PSU	PVC	PVC	PTFE	NBR	AL
	Chromic acid	CrO ₃	10	1	4	2	4	1	4	1	-	1	4	1
	Chromic potassium sulphate	KCr(SO ₄) ₂ x 12H ₂ O	saturated	1	2	1	3	1	-	1	-	1	-	3
	Citric acid	C ₆ H ₈ O ₇	10	1	1	1	2	1	1	1	1	1	1	1
	Citric acid	C ₆ H ₈ O ₇	50	1	3	1	2	1	-	-	-	1	1	1
	Copper sulphate	CuSO ₄ x 5H ₂ O	10	1	1	1	1	1	1	1	1	1	1	4
	Cyclohexanol	C ₆ H ₁₂ O	100	1	1	3	1	1	1	1	4	1	2	1
	Decane	C ₁₀ H ₂₂	100	-	1	2	1	3	-	-	-	1	2	1
	Diaminoethane	C ₂ H ₈ N ₂	100	1	1	3	1	1	-	3	4	1	1	1
	Diesel fuel	—	100	1	1	3	1	1	-	1	3	1	1	1
	Dimethyl formamide (DMF)	C ₃ D ₇ NO	100	1	1	4	1	1	4	3	-	1	3	1
	Dimethyl sulfoxide (DMSO)	C ₂ H ₆ SO	100	1	2	4	1	1	4	4	-	1	-	1
	Dimethylaniline	C ₈ H ₁₁ N	100	-	3	4	2	4	-	-	-	1	-	1
	Dioxane	C ₄ H ₈ O ₂	100	2	1	4	1	3	2	3	4	1	3	1
	Dipropylene glycol (mono)methyl ether	C ₄ H ₁₀ O	100	3	1	4	1	4	4	4	4	1	-	1
	Ethyl acetate	C ₄ H ₈ O ₂	100	1	1	4	1	1	4	4	4	1	4	1
	Ethylene chloride	C ₂ H ₄ Cl ₂	100	3	3	4	1	3	4	4	4	1	-	1
	Ferrous chloride	FeCl ₂	saturated	1	3	1	3	1	1	1	1	1	-	4
	Formaldehyde solution	CH ₂ O	30	1	3	1	1	1	-	-	-	1	2	1
	Formic acid	CH ₂ O ₂	100	1	4	3	4	1	3	3	1	1	2	1
	Furfural	C ₅ H ₄ O ₂	100	1	3	3	2	4	-	-	-	1	4	1
	Gasoline	C ₅ H ₁₂ - C ₁₂ H ₂₆	100	2	1	3	1	3	3	2	-	1	1	1
	Glycerol	C ₃ H ₈ O ₃	100	1	1	3	1	1	1	1	2	1	1	1
	Heptane, normal	C ₇ H ₁₆	100	2	1	1	1	2	1	2	4	1	1	1
	Hexane, n-	C ₆ H ₁₄	100	2	1	2	1	2	1	2	4	1	1	1
	Hydrogen chloride	HCl	5	1	4	1	4	1	1	1	-	1	2	4
	Hydrogen chloride	HCl	concentrated	1	4	4	4	1	1	2	3	1	4	4
	Hydrogen peroxide	H ₂ O ₂	3	1	3	1	1	1	1	1	-	1	3	3
	Hydrogen peroxide	H ₂ O ₂	30	1	4	1	4	1	1	1	-	1	3	3
	Hydrogen sulphide	H ₂ S	10	1	1	1	1	1	1	1	3	1	3	1
	Iodine, tincture of	I ₂		1	4	3	1	1	-	4	4	1	1	1

11 Appendix

- no data 1 resistant 2 practically resistant 3 partially resistant 4 not resistant	Medium	Formula	Concentration [%]	High Density Polyethylene	Polyamide	Polycarbonate	Polyoxymethylene	Polypropylene	Polysulfone	Polyvinyl chloride, hard	Polyvinyl chloride, weak	Polytetrafluorethylene	Acrylonitrile-butadiene- caoutchouc	Aluminium
				HDPE	PA	PC	POM	PP	PSU	PVC	PVC	PTFE	NBR	AL
	Isopropyl alcohol	C ₃ H ₈ O	100	1	1	1	1	1	1	1	4	1	-	2
	Lactic acid	C ₃ H ₆ O ₃	3	1	3	1	2	1	1	2	-	1	1	1
	Magnesium chloride	MgCl ₂	10	1	1	1	1	1	1	1	1	1	1	1
	Mercuric chloride	HgCl ₂	10	1	4	1	3	1	1	1	1	1	1	4
	Mercury	Hg	100	1	1	1	1	1	1	1	3	1	1	3
	Methyl acetate	C ₃ H ₆ O ₂	100	1	1	4	2	1	-	4	4	1	-	1
	Methyl alcohol	CH ₄ O	100	1	2	4	1	1	3	1	3	1	2	1
	Methyl benzene	C ₇ H ₈	100	3	1	4	1	3	4	4	4	1	4	1
	Methyl ethyl ketone (MEK)	C ₄ H ₈ O	100	1	1	4	1	1	4	4	4	1	4	1
	Methylene chloride	CH ₂ Cl ₂	100	4	3	4	3	3	4	4	4	1	-	1
	Mineral oil	—	100	1	1	1	1	1	1	1	-	1	1	1
	Nitric acid	HNO ₃	10	1	4	1	4	1	1	1	-	1	4	3
	Nitric acid	HNO ₃	100	4	4	4	4	4	-	4	-	1	4	1
	Nitrobenzene	C ₆ H ₅ NO ₂	100	3	4	4	3	2	4	4	4	1	4	1
	Oleic acid	C ₁₈ H ₃₄ O ₂	100	1	1	1	2	1	-	1	-	1	3	1
	Oxalic acid	C ₂ H ₂ O ₄ x 2H ₂ O	100	1	3	1	4	1	1	1	1	1	2	1
	Ozone	O ₃	100	3	4	1	4	3	1	1	-	1	4	2
	Petroleum	—	100	1	1	3	1	1	1	1	3	1	1	1
	Phenol	C ₆ H ₆ O	10	1	4	4	4	1	4	1	3	1	3	1
	Phenol	C ₆ H ₆ O	100	2	4	4	4	1	3	4	3	1	3	1
	Phosphoric acid	H ₃ PO ₄	20	1	4	2	4	1	-	-	-	1	2	4
	Phosphorus pentachloride	PCl ₅	100	-	4	4	4	1	-	4	4	1	-	1
	Potassium hydrogen carbonate	CHKO ₃	saturated	1	1	2	1	1	-	-	-	1	-	4
	Potassium hydroxide	KOH	30	1	1	4	3	1	1	1	1	1	-	4
	Potassium hydroxide	KOH	50	1	1	4	3	1	1	1	1	1	-	4
	Potassium nitrate	KNO ₃	10	1	1	1	1	1	-	-	-	1	1	1
	Potassium permanganate	KMnO ₄	100	1	4	1	1	1	-	1	-	1	3	1
	Pyridine	C ₅ H ₅ N	100	1	1	4	1	3	4	4	4	1	4	1
	Resorcinol	C ₆ H ₆ O ₂	5	1	4	2	3	1	4	2	-	1	-	2
	Silver nitrate	AgNO ₃	100	1	1	1	1	1	1	1	1	1	2	4

11 Appendix

- no data 1 resistant 2 practically resistant 3 partially resistant 4 not resistant		Concentration	High Density Polyethylene	Polyamide	Polycarbonate	Polyoxymethylene	Polypropylene	Polysulfone	Polyvinyl chloride, hard	Polyvinyl chloride, weak	Polytetrafluorethylene	Acrylonitrile-butadiene-caoutchouc	Aluminium
			[%]	HDPE	PA	PC	POM	PP	PSU	PVC	PVC	PTFE	NBR
Medium	Formula												
	Sodium bisulphite	NaHSO ₃	10	1	1	2	4	1	-	-	1	1	1
	Sodium carbonate	Na ₂ CO ₃	10	1	1	1	1	1	-	-	1	-	3
	Sodium chloride	NaCl	30	1	1	1	1	1	1	1	1	1	3
	Sodium hydroxide	NaOH	30	1	1	4	1	1	1	1	1	2	4
	Sodium hydroxide	NaOH	50	1	1	4	1	1	1	-	1	2	4
	Sodium sulfate	Na ₂ SO ₄	10	1	1	1	1	1	1	1	1	1	1
	Spirits	C ₂ H ₆ O	96	1	1	1	1	1	1	3	1	-	1
	Styrene	C ₈ H ₈	100	4	1	4	1	3	-	4	4	4	1
	Sulphuric acid	H ₂ SO ₄	6	1	4	1	4	1	1	1	-	1	2
	Sulphuric acid	H ₂ SO ₄	fuming	4	4	4	4	4	4	4	4	1	4
	Tallow	—	100	1	1	1	1	1	-	1	1	1	1
	Tetrahydrofuran (THF)	C ₄ H ₈ O	100	3	1	4	1	3	4	4	4	1	3
	Tetrahydronaphthalene	C ₁₀ H ₁₂	100	3	1	4	1	4	4	4	4	1	-
	Thionyl chloride	Cl ₂ SO	100	4	4	4	2	4	4	4	4	1	-
	Tin chloride	SnCl ₂	10	1	4	2	2	1	-	-	-	1	1
	Transformer oil	—	100	1	1	3	3	1	1	1	-	1	1
	Trichloroethane	C ₂ H ₃ Cl ₃	100	3	3	4	2	4	4	4	4	1	4
	Urea	CH ₄ N ₂ O	10	1	1	1	1	1	-	-	-	1	1
	Urine	—	100	1	1	1	1	1	-	1	1	1	-
	Vinegar	C ₂ H ₄ O ₂	10	1	4	1	1	1	1	1	1	1	2
	Vinegar	C ₂ H ₄ O ₂	90	1	4	4	4	1	3	1	4	1	-
	Wax	—	100	-	1	1		1	-	-	-	1	-
	Wines	—	100	1	1	1	2	1	1	1	1	1	-
	Xylene	C ₈ H ₁₀	100	3	1	4	1	4	4	4	4	1	4

11.6 EC declaration of conformity



EC – DECLARATION OF CONFORMITY

The product named hereinafter was developed, designed, and manufactured in compliance with the relevant, fundamental safety and health requirements of the listed EC directives and norms.

In the event of modifications that were not authorised by us or if the product is used in a manner that is not in line with the intended purpose, this declaration will be rendered void.

<i>Product name:</i>	Laboratory centrifuge
<i>Product type:</i>	Sigma 3-18 KS, Sigma 3-18KHS
<i>Order number:</i>	10370, 10371, 10372, 10373, 10374, 90904, 91033
<i>Directives:</i>	2006/42/EC Machinery Directive 2014/35/EU Low Voltage Directive 2014/30/EU EMC Directive 2011/65/EU RoHS Directive
<i>Normes:</i>	EN 61010-2-020:2006 EN 61000-3-2:2006, A1:2009, A2:2009 EN 61000-3-3:2013 EN 61326-1:2013

Sigma Laborzentrifugen GmbH

An der Unteren Söse 50
37520 Osterode
Germany

Authorised representative
for CE matters:
Eckhard Tödteberg

Osterode, 01/03/2016



General Manager

CE_3-18KS_2016-03-01_en

11 Appendix

12 Index

A

Acceleration	36
Acceleration curve	36, 47, 74
Acceleration curve (changing).....	47
Acceleration curve (creating)	47
Accessories, cleaning and care.....	59
Acid.....	20, 58, 60
Acoustic signal.....	54
Activating the help function	48
Adapters	30, 59
Adapters and stainless steel tubes.....	71
Alkaline solutions	20, 58, 60
Ambient conditions.....	67
Ambient temperature	67
Anodised coating	59
Application examples	13
Autoclaving	62
Automatic lid opening function	44
Automatic program rotation.....	52
Automatic rotor identification.....	35

B

Blocking a function.....	43
Brake	36
Brakeless deceleration.....	36
Brakeless deceleration from set speed	42
Brief mains power failure.....	54
Bucket.....	30
Buckets, cleaning and care	60
Buzzer/signal	46

C

Capacity.....	67
Carrier.....	30
Carrier systems.....	30
Carriers, cleaning and care	60
CE mark in compliance with the directive 2006/42/EC	15
Centrifugation monitoring	41
Centrifugation of infectious, toxic, radioactive, or pathogenic substances.....	19
Centrifugation principle	13
Centrifugation with different tube sizes.....	29

Centrifugation with low capacity.....	29
Centrifuge cannot be started.....	54
Centrifuge decelerates during operation	54
Centrifuge is inclined.....	54
Centrifuge was moved during run	54
Centrifuge, cleaning and care	58
Centrifuges	
- definition.....	9
Changes in colour.....	62
Changes in structure.....	62
Changing an acceleration curve.....	47
Changing the code.....	43
Chemical and biological safety.....	19
Chemical resistance of plastic.....	60
Cleaning agents.....	61
Cleaning the bores of angle rotors	59
Cleaning the centrifuge	58
Closing the lid	18, 27
Communication error	56
Condensation.....	26
Condenser dirty	54
Condenser, cleaning and care	59
Connected load.....	67
Contamination.....	19, 59
Continuous heat resistance.....	61
Continuous run	34
Contrast (changing)	49
Control system.....	31
Copyright	10
Corrosion	18, 21, 30, 58, 59, 60, 61
Cost estimate.....	64
Cracking	59
Cracks	60
Creating an acceleration curve.....	47
Current consumption.....	67
Curve menu	47
Customer-provided fuses	26
Cycles.....	27, 46

D

Damage of the surface.....	60
Dangerous goods.....	20
Dangerous materials.....	61

Index

Deactivating the help function	48	G	General conditions	9
Deceleration (brake)	36		Glass breakage.....	61
Deceleration curve	36, 47, 74		Glass particles	61
Declaration of conformity	10, 81		Gravitational field	67
Declaration of decontamination.....	64		Grease for load bearing bolts.....	10, 58, 60
Declaration of Decontamination	66	H		
Decontamination agent	59, 61		Hazard warnings.....	9, 28, 30
Deformation of tubes.....	62		Heater.....	33
Deleting a program	51		Help function.....	48
Density.....	20, 41		Highly corrosive substances	18
Dialog box.....	22	I		
Different service life of rotors and accessories	21, 76		Imbalance	29, 30, 60
Dimensions	24		Imbalance error.....	56
Direct hazard to the life and health.....	16		Imbalance monitoring system	22
Directive 2002/96/EC	66		Importance of the operating manual.....	9
Disinfectants	61		Important information	16
Disinfection of the rotor chamber and accessories	61		Improper loading.....	54
Display.....	31, 45		Infectious substances	61
Display deceleration time	45		Inflammable substances	19
Disposal of the centrifuge.....	66		Informal safety instructions	17
Disposal of the packaging	66		Initial start-up	27
Documentation.....	10		Input fuse.....	67
Drive problem	54		Inspection by the manufacturer	63
E			Installation of accessories	29
Earth conductor check	22		Installation of angle rotors with a hermetically sealed lid.....	28
EC declaration of conformity	10, 81		Installation of rotors and accessories	27
EEPROM error.....	56		Installation of the rotor	27
Electrical connection	67		Installation site	26
Electrical safety.....	18		Intended use	9
Emergency lid release	55		Interrupting a centrifugation run	32
Equipotential bonding screw	22		Interrupting a deceleration process	32
Error correction	54		Invert.....	45
Error message	54		IP code	67
Executing a program.....	51	K		
Explanation of the symbols and notes.....	16		kin. energy	67
Explosive substances	19	L		
External signal	46		Language.....	45
F			Layout of the centrifuge.....	11
Fire preventions	19		Leaks	30, 62
Form for the return of defective parts	64		Lid cannot be opened	54
Function.....	44		Lid error	56
Functional and operating elements	11			
Fuses have tripped	54			

Lid lock device	22	Opening the lid.....	27
Lid lock has not released	54	Operating personnel	17
Lid seal sticks	54	Operating voltage.....	26
Limit "Delta T"	42	Operational safety.....	59
Linear curves	74	Option for the input and output of data	46
Load bearing bolts, cleaning and care.....	60	Options for data input and output	53
Loading a process.....	39	Overseas shipping	24
Loading a program.....	50	P	
Lock.....	43	Packaging	25
M		Parameter error	56
Mains power switch off.....	54	Parameters menu	40
Mains switch	11	Pathogenic substances	19, 58, 61
Mains voltage.....	18	Plastic accessories, cleaning and care.....	60
Maintenance	58	Potential hazard to the life and health	16
Malfunctions and error correction.....	54	Potentially hazardous situation.....	16
Manual mode	32	Power consumption	67
Manufacturer.....	67	Power cord is not plugged in.....	54
Marking of the unit	15	Power supply	26
Maximum speed for tubes.....	72	Pressure marks.....	60
Measures in the event of hazards and accidents	23	Prevention of accidents.....	9
Mechanical safety	18	Problem description	64
Menu Curve	47	Process.....	40
Menu Help	48	Process error	56
Menu Parameters	40	Process library	39
Menu Processlibrary	39	Program "RAPID_TEMP"	36
Menu Setup	44	Program list.....	36, 50, 51
Menu Standard	33	Program mode	49
Mode of operation.....	13	Program rotation	44
Modification mode active.....	32	Progress indicator	38
Motor error	56	Protection class	26, 67
Motor shaft.....	27, 28, 58	Q	
Multiple carrier	30	Quadratic curves.....	74
N		Quick stop.....	32
Name plate	11, 12	R	
No indication on the display	54	Radioactive substances	19, 58
No power in the mains supply	54	Radius	14, 40
Noise level	67	Range of accessories	69
Non-greased bolts.....	60	RAPID_TEMP program.....	36
Notes on safety and hazards	9	RCF	33
Notes on transport	24	Relative centrifugal force (RCF)	14, 33
O		Removal of the transport safety device	25
Online download of forms	65	Remove glass particles and metal dust from the rotor chamber	61
Open lid after run	44	Responsibility of the operator.....	17

Index

Return of centrifuges, spare parts, or accessories	64	Speed/RCF fine	45
Return of defective parts	64	Speed-gravitational-field-diagram	73
Risk of electrical shock.....	18	Speedometer error.....	56
Rotor chamber	58	Spin-out from set speed	42
Rotor identification, automatic.....	35	Standard menu	33
Rotor monitoring system	22	Standards and regulations	10
Rotor radii	72	Standstill cooling.....	40
Rotor selection list.....	35	Standstill monitoring system	22
Rotor tie-down screw	27, 28, 60	Start delay.....	45
Rotor wrench	10, 27, 28	Starting a centrifugation run	32
Rotors and accessories with a different service life	21, 76	Starting a process.....	39
Rotors for microtiter plate formats	28	Sterilisation of the rotor chamber and accessories	61
Rotors, cleaning and care	60	Storage and transport	24
Runtime	34	Storage conditions	24
Runtime as of set speed	44	Storage locations	67
S		Stress-corrosion	
Safety area	20	see	
Safety devices	22	corrosion	60
Safety distance	18, 20, 26	Structural changes	19
Safety instructions.....	9, 28, 30	Supply voltage	26
Safety instructions for centrifugation	20	Switching the centrifuge off	53
Safety, chemical and biological.....	19	Switching the centrifuge on	27
Safety, electrical	18	System.....	46
Safety, mechanical.....	18	System check	22
Safety-conscious work	17	System error	54, 56
Saving a program.....	50	T	
Scope of supply	10	Table of error codes.....	56
Selection, display, and modification of data	32	Table of rotors and accessories with a different service life	21, 76
Serial number	12, 57, 63	Technical data	67
Service.....	63	Technical documentation	68
Service contact	57	Temperature	33
Service life	58	Temperature error.....	56
Service life of rotors and accessories... 21, 76		Temperature inside the rotor chamber	22
Service life of the accessories.....	62	Temperature monitoring.....	42
Service work	63	Temperature monitoring system.....	22
Set-up and connection	26	Temperature unit.....	45
Setup menu	44	Temperature value not reached	54
Short run.....	34	Thermal stress	58
Solvents.....	20, 58, 60	Time fine.....	45
Sound signal	22	Time range.....	67
Sound signal (warning)	46	Toxic substances	19, 58
Spare part enquiries.....	57	Transport safety device.....	25
Speed	14, 33, 67	Tubes.....	30

Type of connection.....	26	Vessels	30
Type of the centrifuge	57, 63, 67	W	
U		Warning signal	46
Unblocking a function.....	43	Warranty and liability.....	9
Ungreased load- bearing bolts	54	Wear	63
Useful volume		Weight	24
- volume that is stated for the tube....	30, 72	Work on the power supply system	18
User interface	31	Y	
UV radiation.....	26, 58	Year of manufacture	12
V			
Vents	26		